

Autonics Dual PID Control Temperature Controller TZN SERIES INSTRUCTION MANUAL



Thank you for choosing our Autonics product.
Please read the following safety considerations before use.

Safety Considerations

- ※Please observe all safety considerations for safe and proper product operation to avoid hazards.
- ※Safety considerations are categorized as follows.
- Warning** Failure to follow these instructions may result in serious injury or death.
- Caution** Failure to follow these instructions may result in personal injury or product damage.
- ※The symbols used on the product and instruction manual represent the following
- ▲ symbol represents caution due to special circumstances in which hazards may occur.

Warning

- Fail-safe device must be installed when using the unit with machinery that may cause serious injury or substantial economic loss.** (e.g. nuclear power control, medical equipment, ships, vehicles, railways, aircraft, combustion apparatus, safety equipment, crime/disaster prevention devices, etc.) Failure to follow this instruction may result in fire, personal injury, or economic loss.
- Install on a device panel to use.** Failure to follow this instruction may result in electric shock.
- Do not connect, repair, or inspect the unit while connected to a power source.** Failure to follow this instruction may result in electric shock or fire.
- Check 'Connections' before wiring.** Failure to follow this instruction may result in fire.
- Do not disassemble or modify the unit.** Failure to follow this instruction may result in electric shock or fire.

Caution

- When connecting the power input and relay output, use AWG 20(0.50mm²) cable or over and tighten the terminal screw with a tightening torque of 1.0N·m.** When connecting the sensor input and communication cable without dedicated cable, use AWG 28-16 cable and tighten the terminal screw with a tightening torque of 1.0N·m. Failure to follow this instruction may result in fire or malfunction due to contact failure.
- Use the unit within the rated specifications.** Failure to follow this instruction may result in fire or product damage.
- Use dry cloth to clean the unit, and do not use water or organic solvent.** Failure to follow this instruction may result in electric shock or fire.
- Do not use the unit in the place where flammable/explosive/corrosive gas, humidity, direct sunlight, radiant heat, vibration, impact, or salinity may be present.** Failure to follow this instruction may result in fire or explosion.
- Keep metal chip, dust, and wire residue from flowing into the unit.** Failure to follow this instruction may result in fire or product damage.

Ordering Information

TZN	4	S	-	1	4	R
Control output	R	Relay output				
SSR drive output	S	SSR drive output				
Current output	C	Current output				
Power supply	4	100-240VAC 50/60Hz				
Option output	1 ^{*1}	Event 1				
	2	Event 1 + Event 2				
	R	Event 1 + PV transmission (DC4-20mA)				
	T	Event 1 + RS485 communication				
	A	Event 1 + Event 2 + PV transmission (DC4-20mA)				
	B	Event 1 + Event 2 + RS485 communication				
Size	S	DIN W48×H48mm				
	M	DIN W72×H72mm				
	W	DIN W96×H48mm				
	H	DIN W48×H96mm				
	L	DIN W96×H96mm				
Digit	4	9999 (4-digit)				
Item	TZN	Temperature controller (PID New Type)				

※The unit cannot be configured with any random combination from the above ordering information. Please refer to Specifications for possible configurations.
※1: TZN4S only supports Event 1 option output.
※The above specifications are subject to change and some model may be discontinued without notice.
※Be sure to follow cautions written in the instruction manual and the technical descriptions (catalog, homepage).

Specifications

Series	TZN4S	TZN4M	TZN4W	TZN4H	TZN4L
Power supply	100-240VAC~50/60Hz				
Allowable voltage range	90 to 110% of rated power voltage				
Power consumption	Max. 5VA (100-240VAC 50/60Hz)		Max. 6VA (100-240VAC 50/60Hz)		
Display method	7-segment LED (PV: red, SV: green)				
Character size	PV (W×H) SV (W×H)	7.8×11.0 mm 5.8×8.0 mm	8.0×13.0 mm 5.0×9.0 mm	7.8×11.0 mm 5.8×8.0 mm	9.8×14.2 mm 8.0×10.0 mm
RTD	DP1100Ω, JP1100Ω, 3-wire (allowed resistance: max. 5Ω per line)				
Input type	TC	K (CA), J (IC), R (PR), E (CR), T (CC), S (PR), N (NN), W (TT) (allowed resistance: max. 100Ω per line)			
Display accuracy	F.S. ±0.3% or 3°C, greater value				
Control output	Relay	250VAC~3A 1c			
	SSR	Max. 12VDC±3V 30mA			
	Current	DC4-20mA (load resistance max. 600Ω)			
Option output	EVENT1	250VAC~1A 1a			
	EVENT2	250VAC~1A 1a			
	PV transmission	DC4-20mA (load resistance max. 600Ω)			
	Communication	RS485 communication			
Control method	ON/OFF, P, PI, PD, PIDF, PIDSD control				
Alarm output hysteresis	1 to 100°C (0.1 to 100.0°C) variable				
Proportional band (P)	0.0 to 100.0%				
Integral time (I)	0 to 3,600 sec				
Derivative time (D)	0 to 3,600 sec				
Control period (T)	1 to 120 sec				
Sampling period	0.5 sec				
LBA setting	1 to 999 sec				
Ramp setting	Ramp Up, Ramp Down: 1 to 99 min each				
Dielectric strength	2,000VAC 50/60Hz for 1 min (between input and power terminals)				
Vibration	Mechanical	0.75mm amplitude at frequency 10 to 55Hz (for 1 min) in each X, Y, Z direction for 2 hours			
	Electrical	0.5mm amplitude at frequency 10 to 55Hz (for 1 min) in each X, Y, Z direction for 10 min			
Relay life cycle	Control output	Mechanical: min. 10,000,000 operations, Electrical: min. 100,000 operations (250VAC 3A resistance load)			
	Option output	Mechanical: min. 20,000,000 operations, Electrical: min. 500,000 operations (250VAC 1A resistance load)			
Insulation resistance	Over 100MΩ (at 500VDC megger)				
Noise immunity	Square shaped noise by noise simulator (pulse width 1μs) ±2kV R-phase, S-phase				
Memory retention	Approx. 10 years (non-volatile semiconductor memory type)				
Environment	Ambient temp.	-10 to 50°C, storage: -20 to 60°C			
	Ambient humi.	35 to 85%RH, storage: 35 to 85%RH			
Approval	CE, RoHS				
Weight ^{*1}	Approx. 226g (approx. 164g)	Approx. 355g (approx. 246g)	Approx. 351g (approx. 232g)	Approx. 474g (approx. 303g)	

※1: The weight includes packaging. The weight in parentheses is for unit only.
※Environment resistance is rated at no freezing or condensation.

Input Type and Range

Input type	Decimal point	Display	Input range (°C)	Input range (°F)	
Thermo couple	K (CA)	1	E C R H	-100 to 1300	-148 to 2372
	K (CA)	0.1	E C R L	-100.0 to 999.9	Not supported
	J (IC)	1	J I C H	0 to 800	32 to 1472
	J (IC)	0.1	J I C L	0.0 to 800.0	Not supported
	R (PR)	1	r P r	0 to 1700	32 to 3092
	E (CR)	1	E C r H	0 to 800	32 to 1472
	E (CR)	0.1	E C r L	0.0 to 800.0	Not supported
	T (CC)	1	E C C H	-200 to 400	-328 to 752
	T (CC)	0.1	E C C L	-199.9 to 400.0	Not supported
	S (PR)	1	S P r	0 to 1700	32 to 3092
N (NN)	1	n n n	0 to 1300	32 to 2372	
W (TT)	1	W T t	0 to 2300	32 to 4172	
RTD	JP1100Ω	1	J P t H	0 to 500	32 to 932
	JP1100Ω	0.1	J P t L	-199.9 to 199.9	-199.9 to 391.8
	DP1100Ω	1	d P t H	0 to 500	32 to 932
	DP1100Ω	0.1	d P t L	-199.9 to 199.9	-199.9 to 391.8
Analog	Voltage	0 - 10VDC	R - - 1	-1999 to 9999	(display range will vary depending on the decimal point.)
	Current	1 - 5VDC	R - - 2		
		DC4 - 20mA	R - - 3		

Configuring Input Type

Please configure the internal switches before supplying power. After supplying power, configure the input type [n - t] in parameter group 2 according to the input type.

Input type	S/W 1	S/W 2
Thermocouple		
RTD	1 1	m A V
Analog	Voltage (0-10VDC, 1-5VDC)	2 2
	Current (DC4-20mA)	2 2

• Detaching the case
Press the front case then pull the case to detach the case from the body. Configure the internal switches as input type.

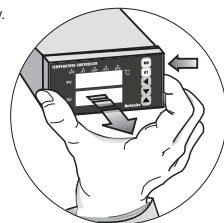

Dimensions

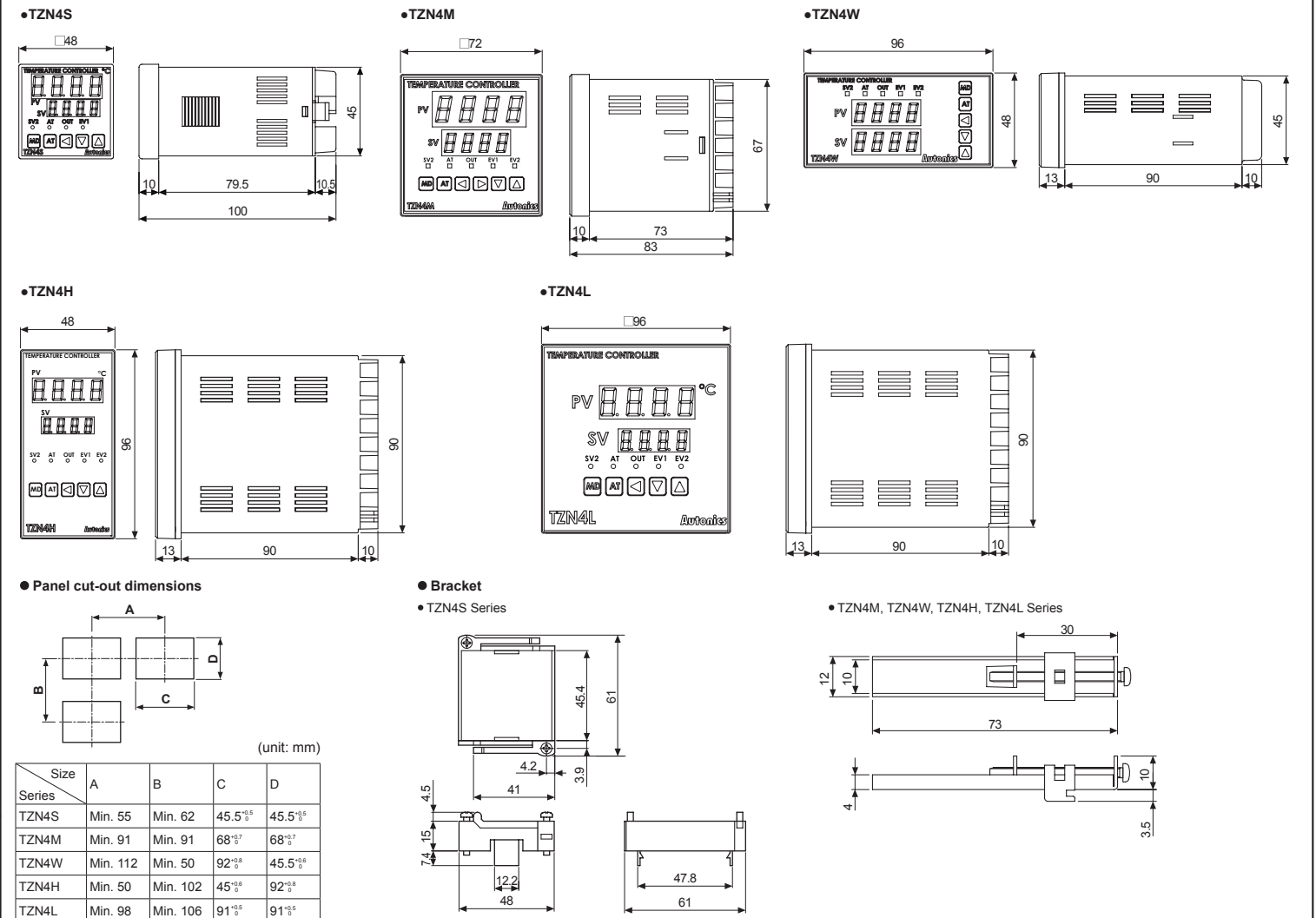

Connections

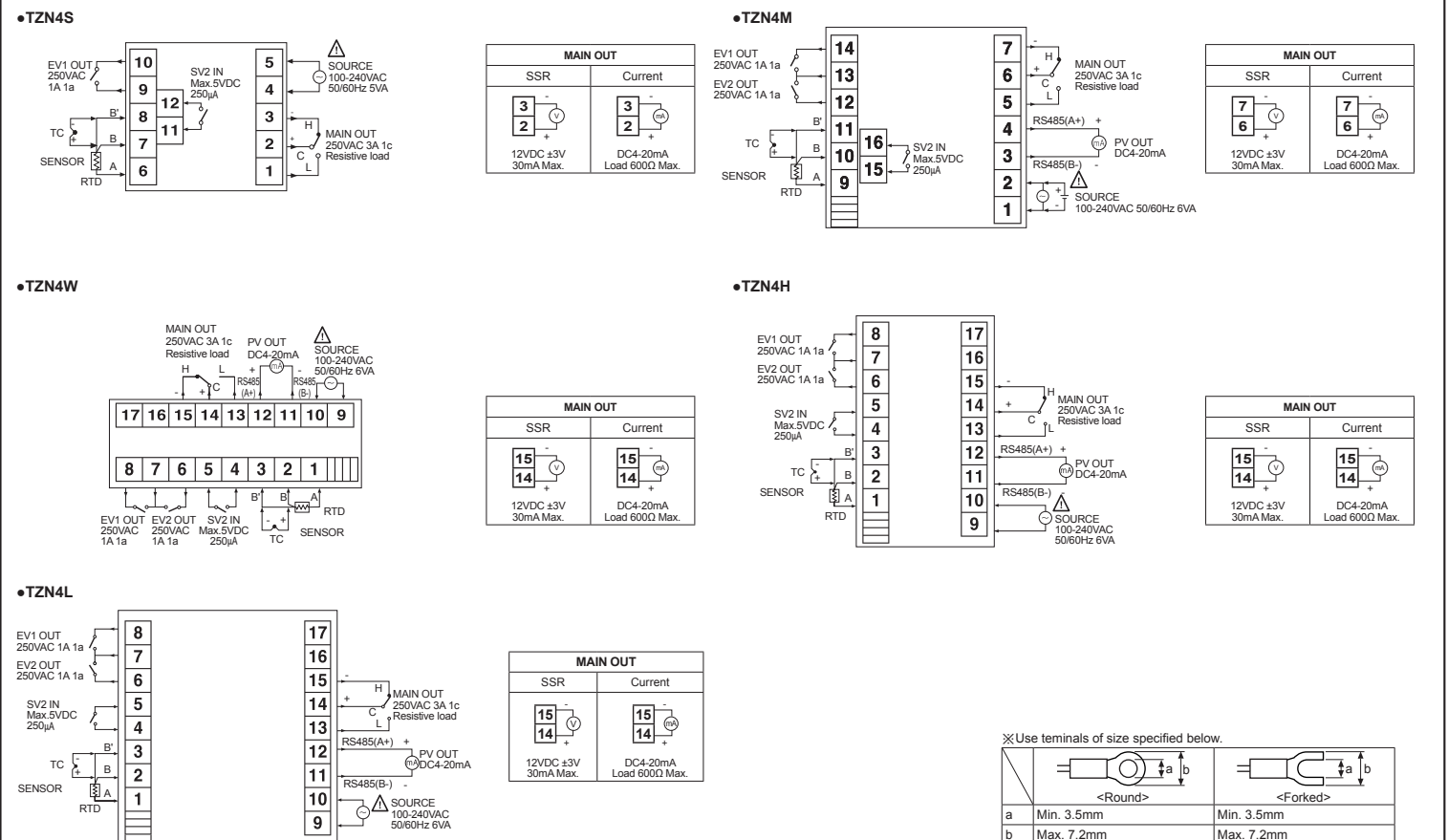

※Use terminals of size specified below.

Terminal type	Min. Size	Max. Size
<Round>	Min. 3.5mm	Max. 7.2mm
<Forked>	Min. 3.5mm	Max. 7.2mm

Parameter groups

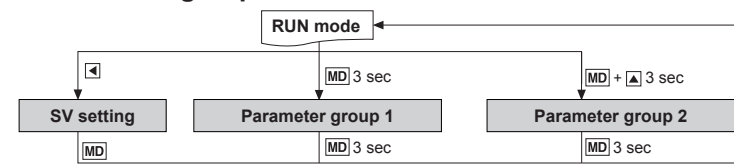

Parameter setting order: **Parameter group 2** → **Parameter group 1** → **SV setting**
 The parameters are related to each other. Please set the parameters in the order above.
 ※When there is no key input for 60 seconds while in SV setting mode or parameter groups, the unit will return to RUN mode automatically.

SV setting

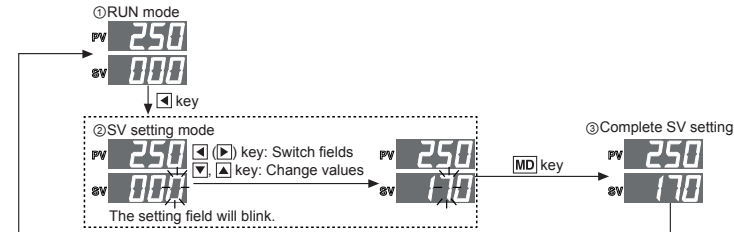

Parameter group 1

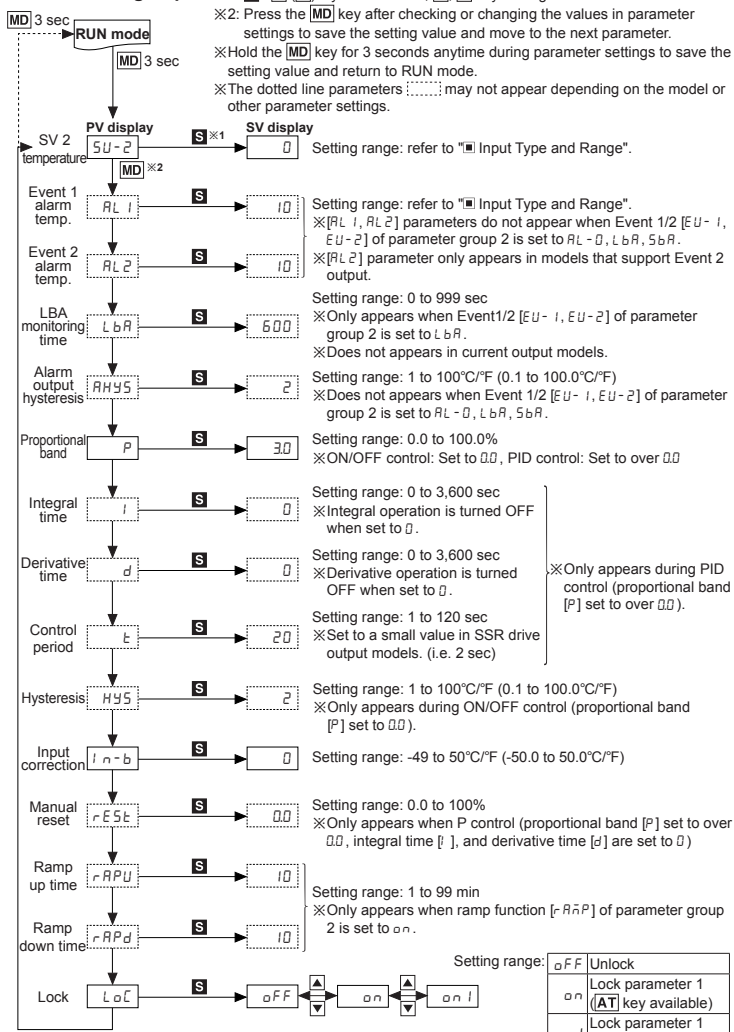

Unit Description

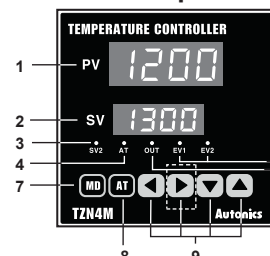

- Present value (PV) display (red):**
 RUN mode: displays the current value (PV)
 Setting mode: displays parameters
 - Set value (SV) display (green):**
 RUN mode: displays the set value (SV)
 Setting mode: displays parameter setting values
 - SV2 operation indicator:** turns ON when SV2 is operating
 - Auto-tuning indicator:** turns ON when auto-tuning
 - Control output operation indicator:** turns ON when control output is ON. Does not operate when the input type is current output.
 - Event output indicator:** turns ON when the according event output is ON.
7. **Mode key:** enter parameter group, return to RUN mode, switch parameters, save setting values
 8. **Auto-tuning key:** hold the key for 3 seconds to start auto-tuning. Hold the key for 5 seconds while auto-tuning to stop auto-tuning.
 9. **Setting keys:** enter SV change mode, switch fields, change value
 ([V] key in the dotted line is only available in TZN4M and TZN4L models)

Parameter group 2

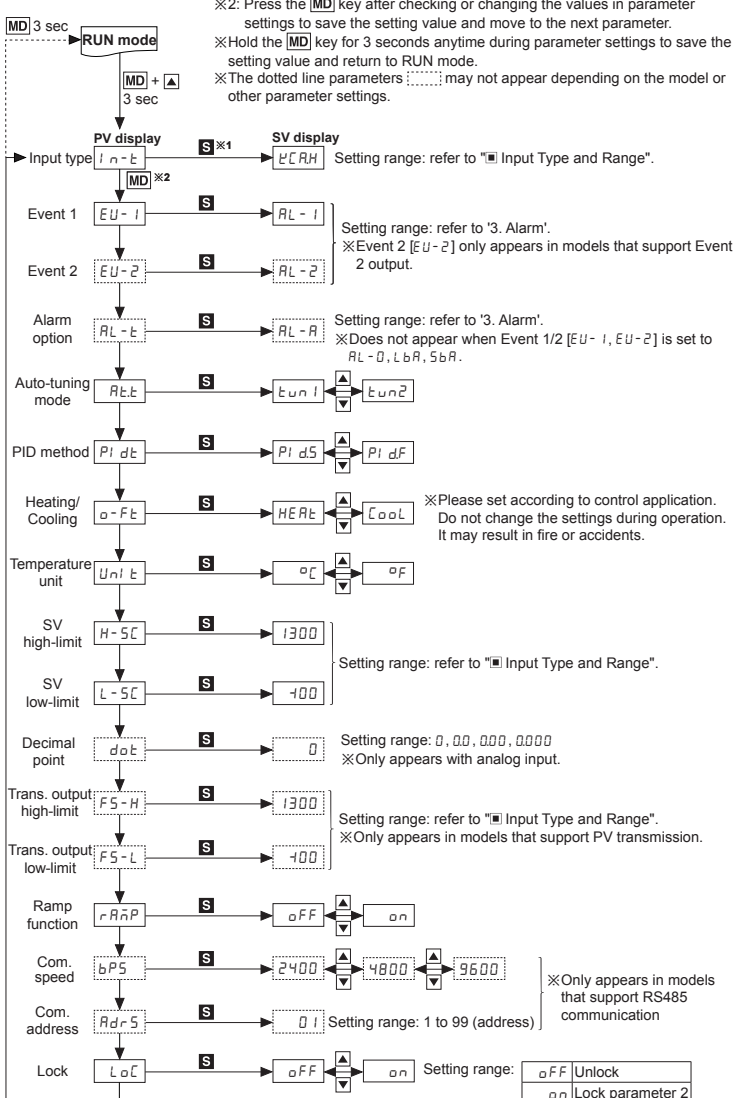

Functions

1. SV2 temperature
 You can control an additional temperature value at a desired range by using SV2. Connect a contact signal (under 5VDC, 250µA) at the external terminal, to operate in the range where the signal turns ON. Set the SV2 temperature in SV2 temperature [5U-2] in parameter group 1.

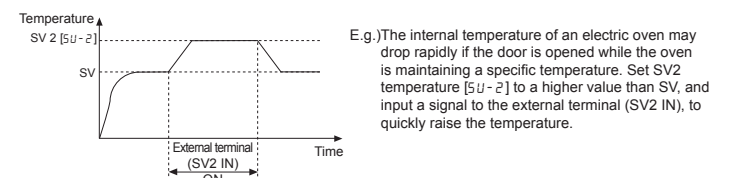

2. Ramp
 The ramp function can delay the rate of temperature rise/fall. If the SV value is changed during stabilized control, the temperature of the controlled target will rise/fall during ramp up/down time [rAPU, rAPd] of parameter group 1. The ramp function activates when the power is reset or when the SV value is changed during stable control. ※The ramp up/down time [rAPU, rAPd] appear only when the ramp function [rAP] of parameter group 2 is set to ON.

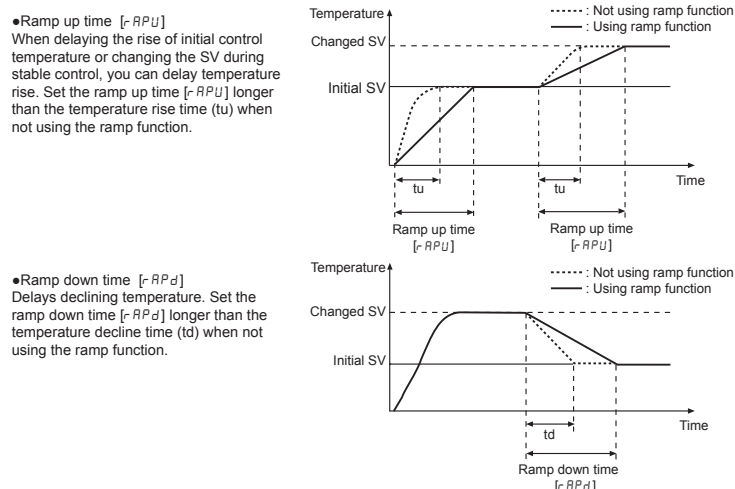

3. Alarm (Event)

Alarm output can be configured by combining alarm operation and alarm options. Set the alarm operation in event 1/2 [EU-1, EU-2] of parameter group 2, and set the alarm options in alarm option [RL-L].

Mode	Name	Alarm operation	Description
RL-0			Alarm output not used.
RL-1	High-limit alarm		If the deviation of PV and SV are higher than the high-limit deviation, the alarm output turns ON.
RL-2	Low-limit alarm		If the deviation of PV and SV are higher than the low-limit deviation, the alarm output turns ON.
RL-3	Deviation high-limit/low-limit alarm		If the deviation of PV and SV are higher than the high-limit deviation or low-limit deviation, the alarm output turns ON.
RL-4	Deviation high-limit/low-limit reverse alarm		If the deviation of PV and SV are higher than the high-limit deviation or low-limit deviation, the alarm output turns OFF.
RL-5	Absolute value high-limit alarm		Alarm output turns ON when PV is higher than the absolute value.
RL-6	Absolute value low-limit alarm		Alarm output turns ON when PV is lower than the absolute value.
SbA	Sensor break	—	Alarm output turns ON when sensor disconnection is detected.
LbA	Loop break	—	Alarm output turns ON when loop break is detected.

※ H: Alarm output hysteresis [RHYS]
 2) Alarm options

Mode	Name	Description
RL-A	Standard alarm	Alarm output turns ON upon alarm condition, and alarm output turns OFF when condition is cleared.
RL-b	Alarm latch	Alarm output turns ON and maintains ON upon alarm condition.
RL-C	Standby sequence	The first alarm condition is ignored. It will operate as standard alarm from the second alarm condition. If it is under alarm condition when power is supplied, it will ignore the condition and operate as standard alarm from the next alarm condition.
RL-d	Alarm latch and standby sequence	It will operate as both alarm latch and standby sequence upon alarm condition. If it is under alarm condition when power is supplied, it will ignore the condition and operate as alarm latch from the next alarm condition.

3) Sensor break alarm
 Alarm output turns ON when sensor is not connected or loses its connection during temperature control. Sensor disconnection can be tested by connecting buzzers or other devices to the alarm output contact. Sensor break alarm output operates through EV1 OUT or EV2 OUT contacts. Alarm output is disengaged after resetting the power.
 4) Loop break Alarm (LBA)
 Diagnose control loop and transmit alarm output through temperature change of control target. During heating (cooling) control, the alarm output turns ON if the PV does not rise/drop by a specific amount (approx. 2°C) during LBA monitoring period [LbA] while control output amount is at 100% (0%).
 ※If the thermal response of the control target is slow, the LBA monitoring period [LbA] of parameter group 1 should be set longer.
 ※LBA only operates when the control output amount is 100% (0%) so it cannot be used in current output models.
 ※If the alarm output turns ON after the sensor has been disconnected, the alarm output will not turn OFF even after reconnecting the sensor. To disengage the alarm output, the temperature controller power must be reset.

4. Auto-tuning
 Auto-tuning allows the temperature controller to detect the thermal characteristics and response rates of the control target. It then calculates the PID time constant and sets the value to allow fast response rates and high accuracy. Hold the [AT] key for 3 seconds during RUN mode to start auto-tuning. The auto-tuning indicator will blink. When auto-tuning is completed, the auto-tuning indicator will turn off and the PID time constant will be saved to each parameter of parameter group 1. The saved parameters can be adjusted as desired.

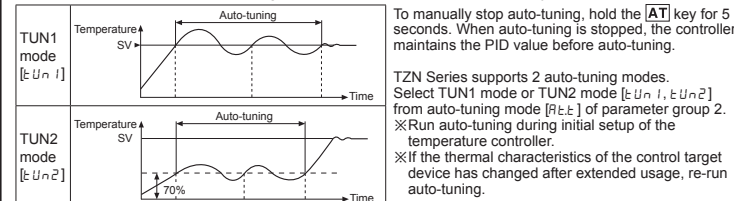

5. Dual PID control
 The response rate of the PID control can be selected depending on the characteristics of the control target. Select high-speed response mode or low-speed response mode [Pi dF, Pi dS] from PID method [Pi dE] of parameter group 2.

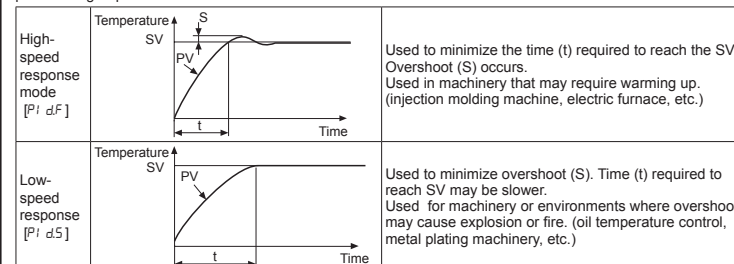

6. Input correction [i n-b]
 Used to correct deviation from external devices such as temperature controllers. E.g.) If the actual temperature is 80°C but the display value is 78°C, set the input correction [i n-b] value to 2 and it will display 80°C as the display value.
 - Configuring manual reset [rESL]
 When using proportional control (P control), the time of temperature rising time and falling time may differ depending on factors such as the heat capacity of the control device or the heater. A certain amount of deviation occurs even under stable conditions. This deviation is referred to as offset, and can be configured/corrected using manual reset [rESL].
 When PV and SV are equal, the reset value is 50.0%. If the PV is lower than the SV during stable control, set the value to over 50.0%, and if the PV is higher than the SV, set the value to under 50.0%.

RS485 Communication

Applicable for models that support RS485 communication. Please refer to 'Ordering Information'. It is used to transmit PV or SV, and/or set the SV.

Protocol	BCC	Communication speed	2400, 4800, 9600bps
Applied standard	EIA RS485	Start bit	1-bit fixed
Max. connections	31 units (address: 1 to 99)	Data bit	8-bit fixed
Communication method	2-wire half duplex	Parity bit	None
Synchronization method	Asynchronous	Stop bit	1-bit fixed
Communication distance	Within 1.2km		

Comprehensive Device Management Program[DAQMaster]

DAQMaster is a comprehensive device management software for setting parameters and monitoring processes. DAQMaster can be downloaded from our website at www.autonics.com.

Item	Minimum specifications
System	IBM PC compatible computer with Pentium III or above
Operations	Windows 98/NT/XP/Vista/7/8/10
Memory	256MB+
Hard disk	1GB+ of available hard disk space
VGA	Resolution: 1024×768 or higher
Others	RS232C serial port (9-pin), USB port

Troubleshooting

Symptoms	Troubleshooting
oPE n is displayed on the PV display during operation	Disconnect the power and check the input connection. If the input is connected, disconnect the input wiring from the temperature controller and short the + and - terminals. Power the temperature controller and check if it displays the room temperature. If it does not display the room temperature and continues to display oPE n, the controller is broken. Please contact our technical support. (Input type is thermocouple)
Load (heater, etc.) does not operate during operation	Check the state of the control output indicator on the front panel. If the indicator is not working, check parameter settings. If the indicator is working, disconnect the wiring from the output terminal of the temperature controller and check the output (replay contact, SSR drive, current)
Err r D (error) is displayed on the PV display during operation	Indicates damage to internal chip by strong noise (2kVAC). Please contact our technical support. Locate the source of the noise and devise countermeasures.

Error Display

Display	Description	Troubleshooting
oPE n	Blinks when input is disconnected.	Check input status.
HHHH	Blinks when the measured input value is higher than the temperature range.	Adjust the value to within the temperature range.
LLLL	Blinks when the measured input value is lower than the temperature range.	

Factory Default

Parameter group 1

Parameter	Default	Parameter	Default	Parameter	Default
5U-2	0	P	30	i n-b	0
RL 1	10	i	0	rESL	00
RL 2	10	d	0	rAPU	10
LbA	600	t	20	rAPd	10
RHYS	2	HYS	2	LoC	oFF

Parameter group 2

Parameter	Default	Parameter	Default	Parameter	Default
i n-t	oFCH	o-Ft	HEAt	F5-L	+00
EU-1	RL-1	Uni t	oC	rAP	oFF
EU-2	RL-2	H-5C	1300	bP5	2400
RL-t	RL-A	L-5C	+00	Rd-5	0 1
At	tun 1	dot	0	LoC	oFF
Pi dE	Pi d5	F5-H	1300		

Cautions during Use

- Follow instructions in 'Cautions during Use'. Otherwise, it may cause unexpected accidents.
- Check the polarity of the terminals before wiring the temperature sensor.
 For RTD temperature sensor, wire it as 3-wire type, using cables in same thickness and length.
 For thermocouple (CT) temperature sensor, use the designated compensation wire for extending wire.
- Keep away from high voltage lines or power lines to prevent induced noise.
 In case installing power line and input signal line closely, use line filter or varistor at power line and shielded wire at input signal line.
 Do not use near the equipment which generates strong magnetic force or high frequency noise.
- Install a power switch or circuit breaker in the easily accessible place for supplying or disconnecting the power.
- Do not use the unit for other purpose (e.g. voltmeter, ammeter), but temperature controller.
- When changing the input sensor, turn off the power first before changing.
 After changing the input sensor, specify internal switch and modify the value of the corresponding parameter.
- Do not overlapping communication line and power line.
 Use twisted pair wire for communication line and connect ferrite bead at each end of line to reduce the effect of external noise.
- Make a required space around the unit for radiation of heat.
 For accurate temperature measurement, warm up the unit over 20 min after turning on the power.
- Make sure that power supply voltage reaches to the rated voltage within 2 sec after supplying power.
- Do not wire to terminals which are not used.
- This unit may be used in the following environments.
 ①Indoors (in the environment condition rated in 'Specifications')
 ②Altitude max. 2,000m
 ③Pollution degree 2

Major Products

- Photoelectric Sensors
- Fiber Optic Sensors
- Door Sensors
- Door Side Sensors
- Area Sensors
- Proximity Sensors
- Pressure Sensors
- Rotary Encoders
- Connector/Sockets
- Switching Mode Power Supplies
- Control Switches/Lamps/Buzzers
- I/O Terminal Blocks & Cables
- Stepper Motors/Drivers/Motion Controllers
- Graphic/Logic Panels
- Field Network Devices
- Laser Marking System (Fiber, CO₂, Nd: YAG)
- Laser Welding/Cutting System
- Temperature Controllers
- Temperature/Humidity Transducers
- SSRs/Power Controllers
- Counters
- Timers
- Panel Meters
- Tachometer/Pulse (Rate) Meters
- Display Units
- Sensor Controllers

Autonics Corporation
<http://www.autonics.com>
HEADQUARTERS:
 18, Bansom-ro 513beon-gil, Haeundae-gu, Busan, South Korea, 48002
 TEL: 82-51-519-3232
E-mail: sales@autonics.com