

DIN W48×H48mm, W72×H36mm, W72×H72mm Counter/Timer

■ Features

- Communication function supported (communication model): RS485 (Modbus RTU)
- One-shot output time setting range - 0.01 sec to 99.99 sec by setting per 10ms
- [Counter]

Prescale value setting range – 6-digit model: 0.00001 to 99999.9 /
4-digit model: 0.001 to 999.9

9 input modes/11 output modes

BATCH counter,

Count Start Point (counting initial value) setting function

- [Timer]

13 output modes

Various time setting range– 6-digit model: 0.001 sec to 99999.9 hour / 4-digit model: 0.001 sec to 9999 hour

'0' time setting function

Selectable timer memory retention function for indicator model.



⚠ Please read "Safety Considerations" in operation manual before using.



■ DAQMaster (Comprehensive Device Management Program)

- DAQMaster is comprehensive device management program for convenient management of parameters and multiple device data monitoring.
- Visit our website (www.autonics.com) to download user manual and comprehensive device management program.

< DAQMaster screen >

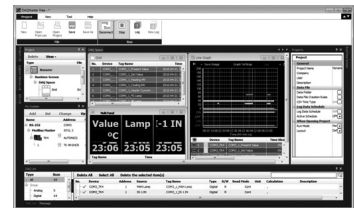

Item	Minimum requirements
System	IBM PC compatible computer with Intel Pentium III or above
Operations	Microsoft Windows 98/NT/XP/Vista/7/8/10
Memory	256MB+
Hard disk	1GB+ of available hard disk space
VGA	Resolution: 1024×768 or higher
Others	RS-232 serial port (9-pin), USB port

■ Ordering Information

CT 6 M - 2P 4 T

Communication	No-mark None
	T RS 485 communication output
Power supply	2 24VAC 50/60Hz, 24-48VDC
	4 100-240VAC 50/60Hz
Output	1P 1-stage preset
	2P 2-stage preset
	I^{※1} Indicator
Size	S DIN W48×H48mm
	Y DIN W72×H36mm
	M DIN W72×H72mm
Display digits	4 9999 (4-digit)
	6 999999 (6-digit)
Item	CT Counter/Timer

※1: CT4S model does not support indicator type.

■ Communication Specification

Comm. protocol	Modbus RTU with 16-bit CRC
Connection type	RS485
Application standard	Compliance with EIA RS485
Max. connection	31 units (address: 1 to 127)
Synchronous method	Asynchronous
Comm. type	Two-wire half duplex
Comm. distance	Max. 800 m
Comm. speed	2400, 4800, 9600 (factory default), 19200, 38400bps
Comm. response time	5 to 99ms (factory default: 20ms)
Start bit	1-bit (fixed)
Data bit	8-bit (fixed)
Parity bit	None (factory default), Even, Odd
Stop bit	1, 2-bit (factory default: 2-bit)

※It is recommended to use Autonics communication converter; SCM-WF48 (Wi-Fi to RS485-USB wireless communication converter, sold separately), SCM-US48I (USB to RS485 converter, sold separately), SCM-38I (RS232C to RS485 converter, sold separately), SCM-US (USB to Serial converter, sold separately). Please use twisted pair wire for RS485 communication.

Programmable Counter/Timer

Specifications

Series		CTS		CTY		CTM		
Model	1-stage preset	CT4S-1P□□	CT6S-1P□□	CT6Y-1P□□	CT6M-1P□□			
	2-stage preset	CT4S-2P□□	CT6S-2P□□	CT6Y-2P□□	CT6M-2P□□			
	Indicator	—	CT6S-□□	CT6Y-□□	CT6M-□□			
Display digits		4-digit	6-digit	6-digit	6-digit			
Display method		7 segment (counting value: red, setting value: yellow-green) LED method						
Character size(W×H)	Counting value	6.5×10mm	4.5×10mm	4.2×9.5mm	6.6×13mm			
	Setting value	4.5×8mm	3.5×7mm	3.5×7mm	5×9mm			
Power supply	AC voltage	100-240VAC~ 50/60Hz						
	AC/DC voltage	24VAC~ 50/60Hz, 24-48VDC==						
Permissible voltage range		90 to 110% of rated voltage						
Power consumption	AC voltage	Max. 12VA						
	AC/DC voltage	AC: Max. 10VA, DC: Max. 8W						
Counter	INA/INB Max. counting speed	Selectable 1cps/30cps/1kcps/5kcps/10kcps						
	Counting range	-999 to 9999		-99999 to 999999				
	Scale	Decimal point up to third digit		Decimal point up to fifth digit				
	Min. input signal width	RESET: Selectable 1ms/20ms						
Timer	Time range	4-digit	9.999s, 99.99s, 999.9s, 9999s, 99m59s, 999.9m, 9999m, 99h59m, 9999h					
		6-digit	999.999s, 9999.99s, 99999.9s, 999999s, 99m59.99s, 999m59.9s, 9999m59s, 99999.9m, 999999m, 99h59m59s, 9999h59m, 99999.9h					
	Operation method	Count up, Count down, Count Up/Down						
	Min. input signal width	INA, INH, RESET: Selectable 1ms/20ms				INA, RESET, INHIBIT, BATCH RESET: Selectable 1ms/20ms		
	Repeat error							
	Set error	In case of power ON start: Max. ±0.01% ±0.05s In case of signal start: Max. ±0.01% ±0.03s						
	Voltage error							
Temp. error								
Input method		Selectable voltage input or no-voltage input [Voltage input]-input impedance: 5.4kΩ, [H]: 5-30VDC==, [L]: 0-2VDC [No-voltage input]-short-circuit impedance: Max. 1kΩ, short-circuit residual voltage: Max. 2VDC==						
One-shot output time		0.01s to 99.99s setting						
		Standard	Comm.	Standard	Comm.	Standard	Comm.	
Control output	Contact output	Type	1-stage	SPDT(1c): 1		SPDT(1c): 1		
			2-stage	SPST(1a): 2		SPST(1a): 1, SPDT(1c): 1	SPST(1a): 2	SPST(1a): 1, SPDT(1c): 1
	Capacity		250VAC~ 5A, 30VDC== 5A resistive load		250VAC~ 3A, 30VDC== 3A resistive load		250VAC~ 5A, 30VDC== 5A resistive load	
	Solid state output (NPN open collector)	Type	1-stage	1	—	1	1	2
2-stage						—	3	2
Capacity		Max. 30VDC==, 100mA						
External power supply		Max. 12VDC== ±10%, 100mA						
Memory retention		Approx. 10 years (non-volatile memory)						
Insulation resistance		Over 100MΩ (at 500VDC megger)						
Dielectric strength		2,000VAC 50/60Hz for 1 min						
Noise immunity		Square-wave noise by noise simulator (pulse width 1μs) ±2kV						
Vibration	Mechanical	0.75mm amplitude at frequency 10 to 55Hz (for 1 min) in each X, Y, Z direction for 1 hour						
	Malfunction	0.5mm amplitude at frequency 10 to 55Hz (for 1 min) in each X, Y, Z direction for 10 minutes						
Shock	Mechanical	300m/s ² (approx. 30G) in each X, Y, Z direction for 3 times						
	Malfunction	100m/s ² (approx. 10G) in each X, Y, Z direction for 3 times						
Relay life cycle	Mechanical	Min. 10,000,000 operations						
	Malfunction	Min. 100,000 operations						
Protection structure		IP65 (front part, IEC standard)						
Environmental	Ambient temp.	-10 to 55°C, storage: -25 to 65°C						
	Ambient humi.	35 to 85%RH, storage: 35 to 85%RH						
Approval		CE c  us						
Weight*1		Approx. 212g (approx. 159g)		Approx. 228g (approx. 140g)		Approx. 322g (approx. 252g)		

*1: The weight includes packaging. The weight in parenthesis is for unit only.

※Environment resistance is rated at no freezing or condensation.

(A) Photoelectric Sensors
(B) Fiber Optic Sensors
(C) Door/Area Sensors
(D) Proximity Sensors
(E) Pressure Sensors
(F) Rotary Encoders
(G) Connectors/ Connector Cables/ Sensor Distribution Boxes/Sockets
(H) Temperature Controllers
(I) SSRs / Power Controllers
(J) Counters
(K) Timers
(L) Panel Meters
(M) Tacho / Speed / Pulse Meters
(N) Display Units
(O) Sensor Controllers
(P) Switching Mode Power Supplies
(Q) Stepper Motors & Drivers & Controllers
(R) Graphic/ Logic Panels
(S) Field Network Devices
(T) Software

Programmable Counter/Timer

● CT6Y-□

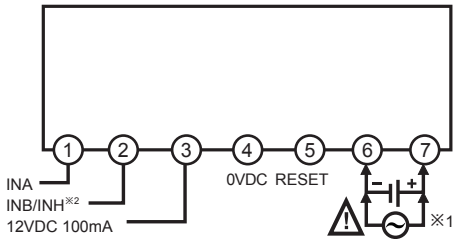

● CT6Y-□T

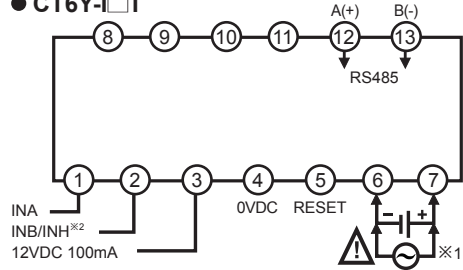

◎ CTM Series

● CT6M-1P□

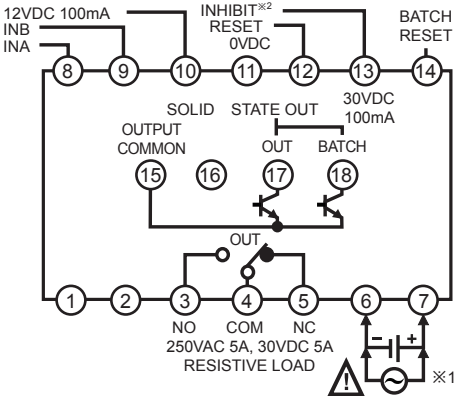

● CT6M-1P□T

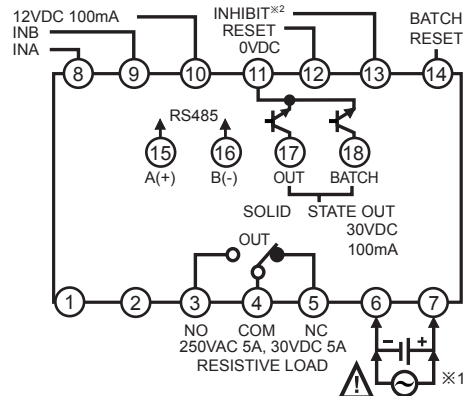

● CT6M-2P□

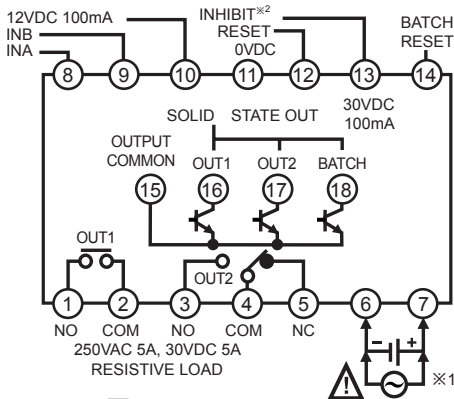

● CT6M-2P□T

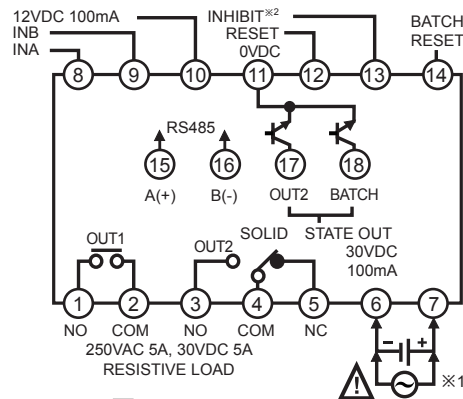

● CT6M-I□

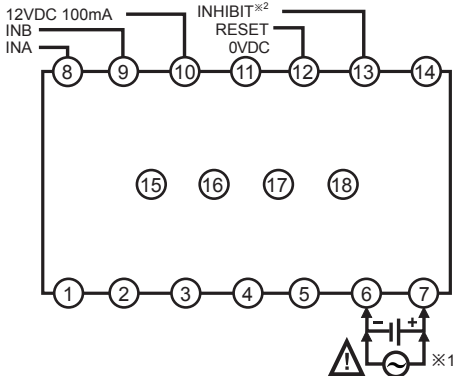

● CT6M-I□T

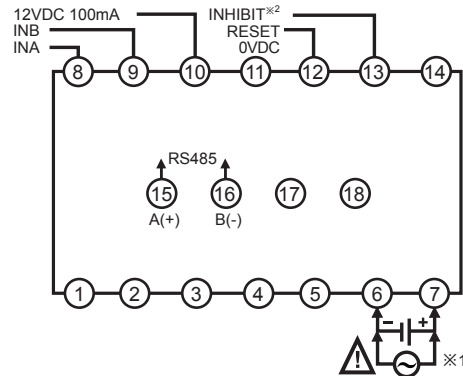

※1: AC Voltage: 100-240VAC 50/60Hz
AC/DC Voltage: 24VAC 50/60Hz, 24-48VDC

※2: Counter operation: If INHIBIT signal is applied, count input will be prohibited.
Timer operation: If INHIBIT signal is applied, time progressing will stop. (HOLD)

(A)	Photoelectric Sensors
(B)	Fiber Optic Sensors
(C)	Door/Area Sensors
(D)	Proximity Sensors
(E)	Pressure Sensors
(F)	Rotary Encoders
(G)	Connectors/ Connector Cables/ Sensor Distribution Boxes/Sockets
(H)	Temperature Controllers
(I)	SSRs / Power Controllers
(J)	Counters
(K)	Timers
(L)	Panel Meters
(M)	Tacho / Speed / Pulse Meters
(N)	Display Units
(O)	Sensor Controllers
(P)	Switching Mode Power Supplies
(Q)	Stepper Motors & Drivers & Controllers
(R)	Graphic/ Logic Panels
(S)	Field Network Devices
(T)	Software

CT Series

■ Dimensions

(unit: mm)

◎ CTS Series

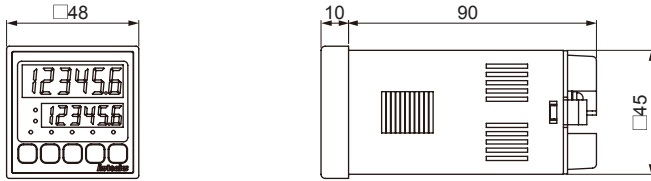

◎ CTY Series

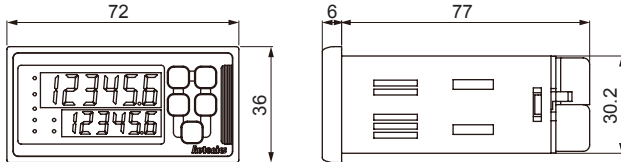

◎ CTM Series

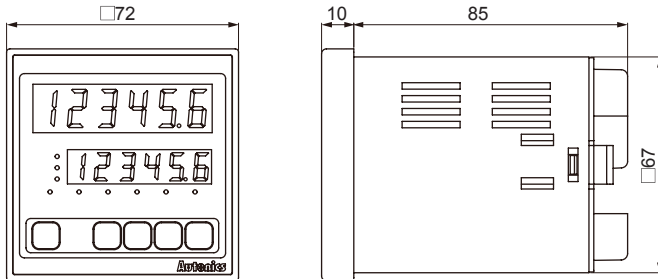

◎ Bracket

● CTS Series

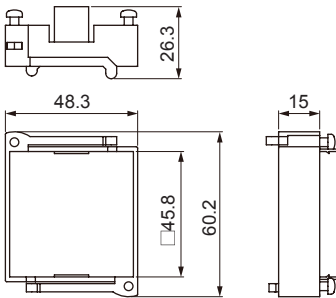

● CTY Series

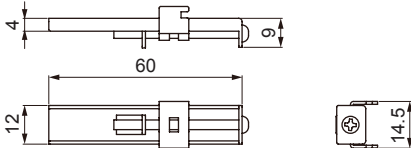

● CTM Series

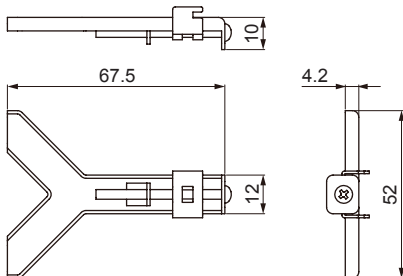

◎ Panel cut-out

● CTS Series

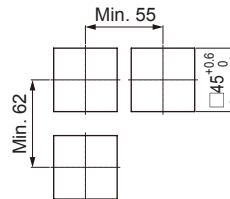

● CTY Series

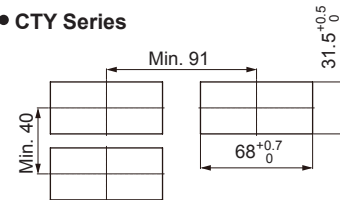

● CTM Series

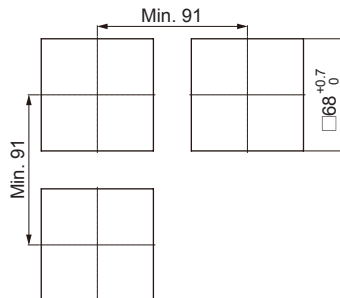

Programmable Counter/Timer

■ Sold Separately

◎ Communication converter

● SCM-WF48

(Wi-Fi to RS485-USB wireless communication converter)



● SCM-US48I

(USB to RS485 converter)



● SCM-38I

(RS232C to RS485 converter)



◎ Display Units (DS/DA-T Series)

● DS/DA-T Series

(RS485 communication input type display unit) CE



DS16-T



DS22/DA22-T



DS40/DA40-T



DS60/DA60-T

※Connect RS485 communication input type display unit (DS/DA-T Series) and RS485 communication output model of CT Series, the display unit displays present value of the device without PC/PLC.

■ Unit Description

◎ CTS Series

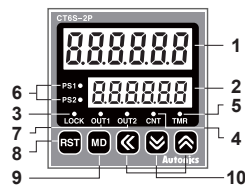

1. Counting value display component (red)

RUN mode: Displays counting value for counter operation or time progress value for timer operation.

Function setting mode: Displays setting item.

2. Setting value display component (yellow-green)

RUN mode: Displays setting value.

Function setting mode: Displays setting content.

3. Key lock indicator (LOCK):

Turns ON for key lock setting.

4. Counter indicator (CNT):

Turns ON for counter operation.

5. Timer indicator (TMR):

Flashes (progressing time) or Turns ON (stopping time) for timer operation.

6. Preset value checking and changing indicator (PS1, PS2)

: Turns ON when checking and changing preset value.

7. Output indicator (OUT1, OUT2):

Turns ON for the dedicated control output ON.

8. **RST** key

RUN mode: Press the **RST** key to reset the counting value.

BATCH counter mode: Press the **RST** key to reset the batch counting value.

9. **MD** key

RUN mode: Hold the **MD** key over 3 sec to enter function setting mode(parameter setting).

Hold the **MD** key over 5 sec to enter function setting mode(communication setting).

Function setting mode: Press the **MD** key to select function setting mode parameter.

Hold the **MD** key over 3 sec to return RUN mode.

10. **↩**, **↲**, **↳** key

1) **↩** key

RUN mode: Press the **↩** key to enter preset mode.

Preset mode: Press the **↩** key to move preset digits.

2) **↲**, **↳** key

RUN mode: Hold the **↲** key over 1 sec to enter Function setting check mode.

Preset mode: Used for increasing or decreasing preset value.

Function setting mode: Changes the settings.

Function setting check mode: Press the **↲** key to move the previous parameter.

Press the **↳** key to the next parameter.

11. **BA** key

RUN mode: Press the **RST** key to enter BATCH counter indication mode.

12. BATCH output indicator (BA.O) (red)

13. BATCH preset value checking and changing indicator (BA.S) (yellow-green)

: Turns ON when checking and changing BATCH preset value.

◎ CTY Series

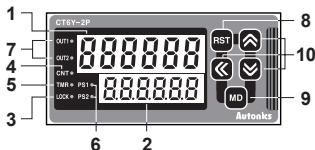

◎ CTM Series

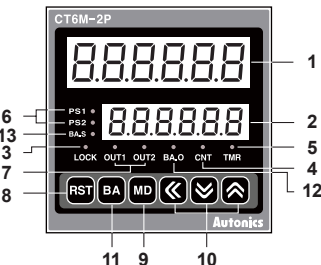

Model	Changed	Notice
CT4S-1P		
CT6S-1P	PS2→PS	There are no PS1, OUT1 LEDs.
CT6Y-1P	OUT2→OUT	
CT6M-1P		
CT6S-I		
CT6Y-I	PS2→PS	There are no PS1, OUT1, OUT2, BA.S, BA.O LEDs, BA key.
CT6M-I		

※The indicator type does not exist in CT4S model.

(A) Photoelectric Sensors

(B) Fiber Optic Sensors

(C) Door/Area Sensors

(D) Proximity Sensors

(E) Pressure Sensors

(F) Rotary Encoders

(G) Connectors/ Connector Cables/ Sensor Distribution Boxes/Sockets

(H) Temperature Controllers

(I) SSRs / Power Controllers

(J) Counters

(K) Timers

(L) Panel Meters

(M) Tacho / Speed / Pulse Meters

(N) Display Units

(O) Sensor Controllers

(P) Switching Mode Power Supplies

(Q) Stepper Motors & Drivers & Controllers

(R) Graphic/ Logic Panels

(S) Field Network Devices

(T) Software

CT Series

Input Connections

No-voltage input (NPN)

Solid-state input (standard sensor: NPN output type sensor)

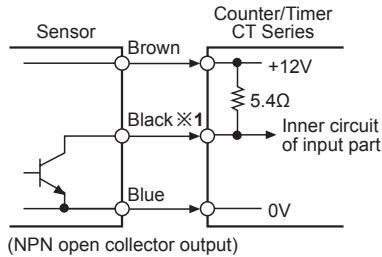
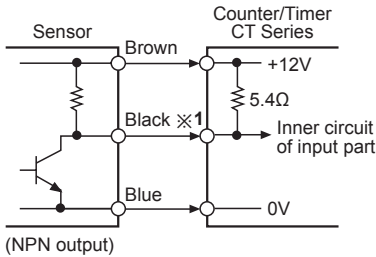

Contact input

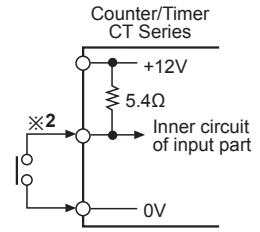

※1: INA, INB/INH, RESET, INHIBIT, BATCH RESET input part

※2: Counting speed: 1 or 30cps setting (counter)

Voltage input (PNP)

Solid-state input (standard sensor: PNP output type sensor)

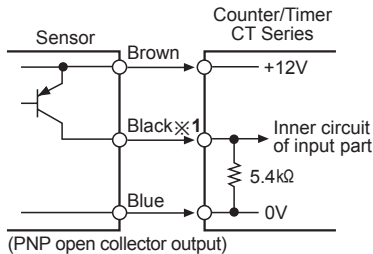
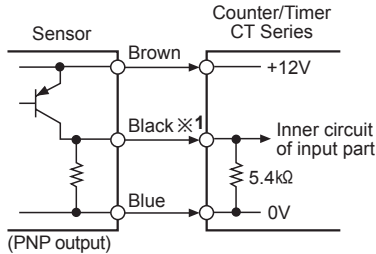

Contact input

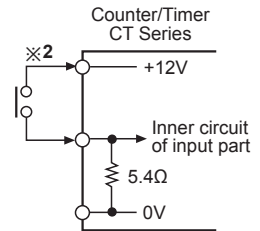

※1: INA, INB/INH, RESET, INHIBIT, BATCH RESET input part

※2: Counting speed: 1 or 30cps setting (counter)

Input Logic Selection [No-Voltage Input (NPN)/Voltage Input (PNP)]

CTS Series

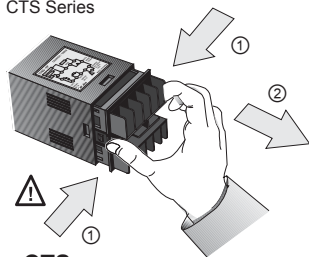

1. The power must be cut off.
2. Squeeze toward ① and pull toward ② as the figure. (CTS/CTY Series)
3. Select input logic by using input logic switch (SW1) inside Counter/Timer.
4. Push a case in the opposite direction of ②.
5. Then supply the power to counter/timer.

⚠ Turn OFF the power before changing input logic (PNP/NPN)

CTS

No-voltage input (NPN) Voltage input (PNP)

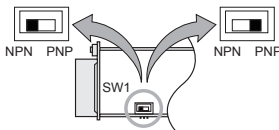

CTY

No-voltage input (NPN) Voltage input (PNP)

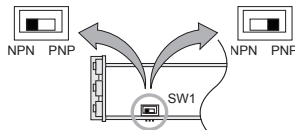

CTM

Voltage input (PNP) No-Voltage input (NPN)

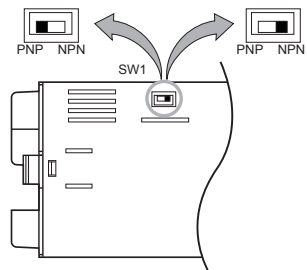

※How to change settings

Power OFF → change settings → power ON → press **[RST]** key or input signal (min. 20ms)

Error Display and Output Operation

Error Display	Error description	Troubleshooting
Err0	Setting value is 0.	Change the setting value anything but 0.

※When error occurs, the output turns OFF.

※When 1st setting value is set as 0 (zero), OUT1 maintains OFF.

When 2nd setting value is smaller than 1st setting value, 1st setting value is ignored and only OUT2 output operates.

※Indicator model does not have error display function.

Programmable Counter/Timer

Output Connections

Contact output

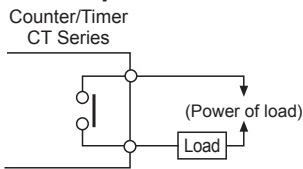

※Use proper load not to exceed the capacity.

Solid-state output

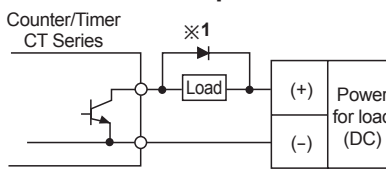

※Use proper load and power for load not to exceed ON/OFF capacity (Max. 30VDC, 100mA) of solid state output.

※Be sure not to apply reverse polarity of power.

※1: When using inductive load (relay etc.), surge absorber (diode, varistor etc.) must be connected between both sides of the load.

Operations and Functions

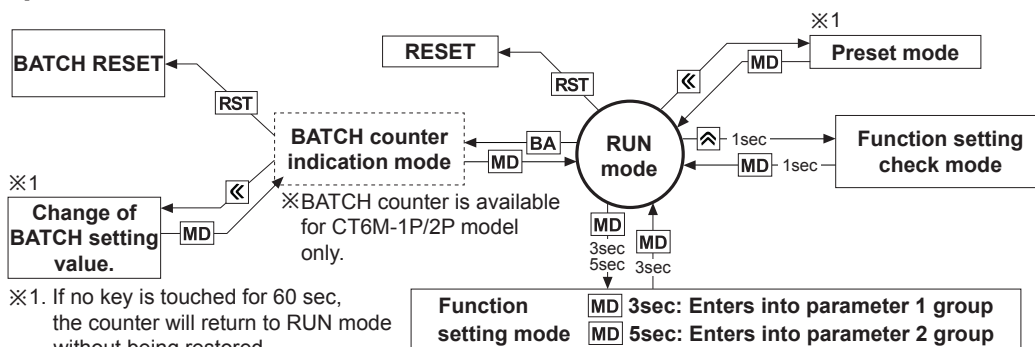

※1. If no key is touched for 60 sec, the counter will return to RUN mode without being restored.

Change of preset (counter/timer)

- Even if changing the preset value, input operation and output control will continue. In addition, the preset value could be set to 0 and the output of 0 preset value turns ON. According to output mode, preset value could not be set to 0. (When setting to 0, preset value "0" will flash 3 times.)

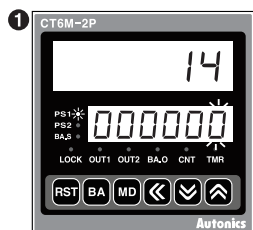

In RUN mode, press the \llcorner key to enter preset mode. 'PS1' indicator turns ON and first digit of preset value flashes.

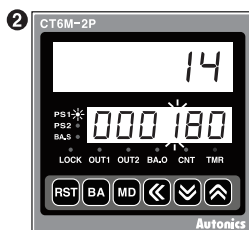

Press the \llcorner , \blacktriangle and \blacktriangledown keys to set the desired value (example, 100). Press the MD key to enter the PS2 setting mode.

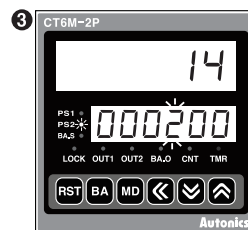

Press the \llcorner , \blacktriangle and \blacktriangledown keys to set the desired value (example, 200). Press the MD key to return RUN mode.

Function setting check mode

Setting value of function setting mode can be confirmed using the \blacktriangle and \blacktriangledown keys.

Switching display function in preset indicator

Setting value1 (PS1) and setting value2 (PS2) are displayed each time pressing MD key in PRESET2 model. (in timer, it is available for *ond*, *ond.1* or *ond.2* output mode.)

Reset

In RUN mode or function setting mode, if pressing RST key or applying the signal to the RESET terminal on the back side, present value will be reset and output will maintain off status. When selecting voltage input (PNP), short no. 10 and no. 12 terminals, or when selecting no-voltage input (NPN), short no.11 and no.12 terminals to reset.

(A)	Photoelectric Sensors
(B)	Fiber Optic Sensors
(C)	Door/Area Sensors
(D)	Proximity Sensors
(E)	Pressure Sensors
(F)	Rotary Encoders
(G)	Connectors/ Connector Cables/ Sensor Distribution Boxes/Sockets
(H)	Temperature Controllers
(I)	SSRs / Power Controllers
(J)	Counters
(K)	Timers
(L)	Panel Meters
(M)	Tacho / Speed / Pulse Meters
(N)	Display Units
(O)	Sensor Controllers
(P)	Switching Mode Power Supplies
(Q)	Stepper Motors & Drivers & Controllers
(R)	Graphic/ Logic Panels
(S)	Field Network Devices
(T)	Software

Programmable Counter/Timer

Flow Chart for Function Setting Mode

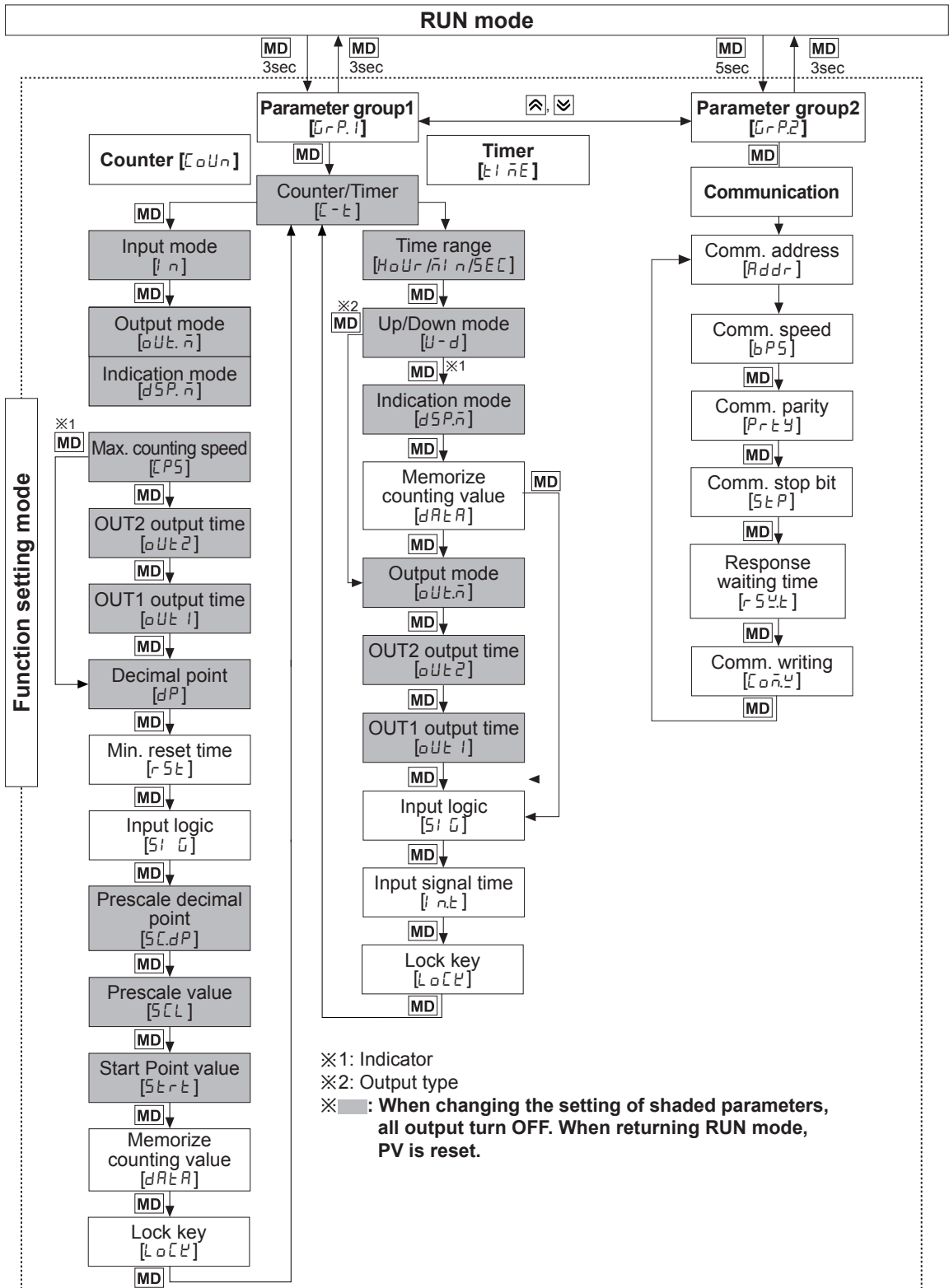

※If changing Parameter group1 setting value, display value and output are reset.
 ※Parameter 2 group is not available to non-communication models.

(A)	Photoelectric Sensors
(B)	Fiber Optic Sensors
(C)	Door/Area Sensors
(D)	Proximity Sensors
(E)	Pressure Sensors
(F)	Rotary Encoders
(G)	Connectors/ Connector Cables/ Sensor Distribution Boxes/Sockets
(H)	Temperature Controllers
(I)	SSRs / Power Controllers
(J)	Counters
(K)	Timers
(L)	Panel Meters
(M)	Tacho / Speed / Pulse Meters
(N)	Display Units
(O)	Sensor Controllers
(P)	Switching Mode Power Supplies
(Q)	Stepper Motors & Drivers & Controllers
(R)	Graphic/ Logic Panels
(S)	Field Network Devices
(T)	Software

Programmable Counter/Timer

Input Operation Mode (Counter)

Input mode	Counting chart	Operation
UP [UP]		<p>※When INA is counting input, INB is no counting input. When INB is counting input, INA is no counting input.</p>
UP-1 [UP-1]		<p>※When INA input signal is rising (↑), it counts. ※INA: Counting input ※INB: No counting input</p>
UP-2 [UP-2]		<p>※When INA input signal is falling (↓), it counts. ※INA: Counting input ※INB: No counting input</p>
Down [dn]		<p>※When INA is counting input, INB is no counting input. When INB is counting input, INA is no counting input.</p>
Down-1 [dn-1]		<p>※When INA input signal is rising (↑), it counts. ※INA: Counting input ※INB: No counting input</p>
Down-2 [dn-2]		<p>※When INA input signal is falling (↓), it counts. ※INA: Counting input ※INB: No counting input</p>
Up/ Down-A [Up-Down-A]		<p>※INA: Counting input INB: Counting command input ※When INB is "L", counting command is up. When INB is "H", it is counting command is down.</p>

- (A) Photoelectric Sensors
- (B) Fiber Optic Sensors
- (C) Door/Area Sensors
- (D) Proximity Sensors
- (E) Pressure Sensors
- (F) Rotary Encoders
- (G) Connectors/ Connector Cables/ Sensor Distribution Boxes/Sockets
- (H) Temperature Controllers
- (I) SSRs / Power Controllers
- (J) Counters
- (K) Timers
- (L) Panel Meters
- (M) Tacho / Speed / Pulse Meters
- (N) Display Units
- (O) Sensor Controllers
- (P) Switching Mode Power Supplies
- (Q) Stepper Motors & Drivers & Controllers
- (R) Graphic/ Logic Panels
- (S) Field Network Devices
- (T) Software

Input Operation Mode (Counter)

Input mode	Counting chart	Operation
Up/ Down-B [Ud-b]		※INA: Up counting input INB: Down counting input ※When INA and INB input signals are rising () at the same time, it maintains previous counting value.
Up/ Down-C [Ud-c]		※When connecting encoder output A, B phase with counter input, INA, INB, set input mode [Ud-c] as phase different input [Ud-c] for counter operation.

※1: For selectable no-voltage input (PNP), voltage input (NPN) model.

※A: over min. signal width, B: over than 1/2 of min. signal width. If the signal is smaller than these width, it may cause counting error (±1).

※The meaning of "H", "L"

Input method	Voltage input (PNP)	No-voltage input (NPN)
Character		
H	5-30VDC	Short
L	0-2VDC	Open

※Min. signal width by counting speed

Counting speed	Min. signal width
1cps	500ms
30cps	16.7ms
1kcps	0.5ms
5kcps	0.1ms
10kcps	0.05ms

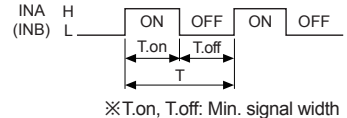

1cps=1Hz

Prescale Function (Counter)

This function is to set and display calculated unit for actual length, liquid, position, etc. It is called "prescale value" for measured length, liquid, or position, etc per 1 pulse. For example, when moving L, the desired length to be measured, and P, the number of pulses per 1 revolution of a rotary encoder, occurs, prescale value is L/P.

E.g.) Positioning control by counter and encoder

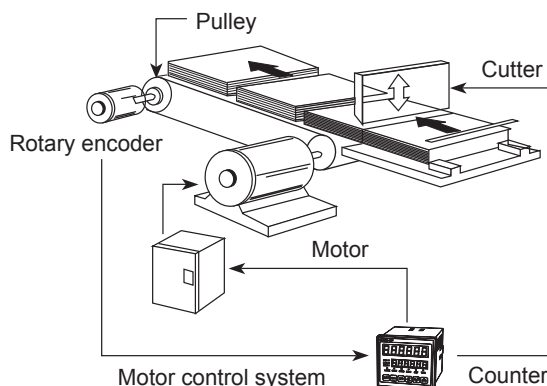

[Diameter (D) of pulley connected with encoder= 22mm, the number of pulses by 1 rotation of encoder=1,000]

$$\begin{aligned}
 \bullet \text{Prescale value} &= \frac{\pi \times \text{Diameter (D) of pulley}}{\text{The number of pulses by 1 rotation of encoder}} \\
 &= \frac{3.1416 \times 22}{1000} \\
 &= 0.069\text{mm/pulse}
 \end{aligned}$$

Set decimal point [dP] as [-----], prescale decimal point [ScdP] as [-----], prescale value [ScL] as [0.069] at function setting mode. It is available to control conveyer position by 0.1mm unit.

Start Point Function (Counter)

This function is that start at initial value set at Start Point [StPt] when on counting mode.

- In case of dn, dn-1 or dn-2 in timer input mode, it is not available.
- When reset is applied, the present value is initialized to start point.
- In case of C, r, P, q output operation mode, the present value starts at START POINT value after counting up.

Programmable Counter/Timer

Output Operation Mode (Counter)

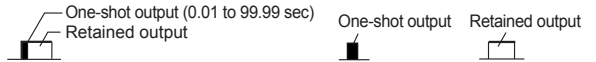

Output mode	Input mode			Operation
	Up, Up-1, 2	Down, Down-1, 2	Up/Down A, B, C	
F [F]				<p>※After count-up, counting display value increases or decreases until reset signal is applied and retained output is maintained.</p>
N [n]				<p>※After count-up, counting display value and retained output are maintained until reset signal is applied.</p>
C [C]				<p>※When count-up, counting display value will be reset and count simultaneously. ※OUT1 retained output will be off after OUT2 one-shot time. ※The one-shot output time of OUT1 one-shot output time is operated regardless of OUT2 output.</p>
R [r]				<p>※After count-up, counting value display is reset after one-shot output time of OUT2 and it counts simultaneously. ※OUT1 retained output will be off after OUT2 one-shot time. ※OUT1 one-shot output time is operated regardless of OUT2 output.</p>
K [k]				<p>※After count-up, counting display value increases or decreases until RESET input is applied. ※OUT1 retained output is off after OUT2 one-shot time. ※OUT1 one-shot output time is operated regardless of OUT2 output.</p>
P [P]				<p>※After count-up, counting display value is maintained while OUT2 output is on. Counting value is internally reset and counts simultaneously. ※When OUT2 output is off, displays counting value while OUT2 is ON, and it increases or decreases. ※OUT1 retained output is off after OUT2 one-shot time. ※OUT1 one-shot output time is operated regardless of OUT2 output.</p>
Q [q]				<p>※After count-up, counting display value increases or decreases during OUT2 one-shot time. ※OUT1 retained output is off after OUT2 one-shot time. ※OUT1 one-shot output time is operated regardless of OUT2 output.</p>
A [A]				<p>※After count-up, counting display value and OUT1 retained output are maintained until RESET input is applied. ※OUT1 one-shot output time is operated regardless of OUT2 output.</p>

※The PRESET1 type output (OUT) is operated as OUT2 of PRESET2 type.
 ※OUT1 output could be set to 0 in all modes and 0 value output turns ON.
 ※OUT2 output could not set to 0 in C[C], R[r], P[P] or Q[q] output mode.

- (A) Photoelectric Sensors
- (B) Fiber Optic Sensors
- (C) Door/Area Sensors
- (D) Proximity Sensors
- (E) Pressure Sensors
- (F) Rotary Encoders
- (G) Connectors/ Connector Cables/ Sensor Distribution Boxes/Sockets
- (H) Temperature Controllers
- (I) SSRs / Power Controllers
- (J) Counters
- (K) Timers
- (L) Panel Meters
- (M) Tacho / Speed / Pulse Meters
- (N) Display Units
- (O) Sensor Controllers
- (P) Switching Mode Power Supplies
- (Q) Stepper Motors & Drivers & Controllers
- (R) Graphic/ Logic Panels
- (S) Field Network Devices
- (T) Software

Output Operation Mode (Counter)

Output mode	Up/Down - A, B, C	Operation
S [5]		Retained output Coincidence output ※OUT1 and OUT2 keep ON status in following condition: Counting display value \geq PRESET1 Counting display value \geq PRESET2
T [t]		※OUT1 output is off: Counting display value \geq PRESET1 ※OUT2 keeps ON status in following condition: Counting display value \geq PRESET2
D [d]		※When counting display value is equal to setting value [PRESET1, PRESET2] only, OUT1 or OUT2 output keeps ON status. ※When setting 1kcps for counting speed, solid state contact output should be used.

- ※The PRESET1 type output (OUT) is operated as OUT2 of PRESET2 type.
- ※The PRESET2 model OUT1 output is operated as one-shot or retained output. (except S, t, d mode)
- ※OUT1 output could be set to 0 in all modes and 0 value output turns ON.
- ※OUT2 output could not set to 0 in C[\bar{C}], R[\bar{r}], P[P] or Q[\bar{q}] output mode.

Counter Operation of the Indicator (CT6S-I, CT6Y-I, CT6M-I)

※Only displays on indicator models

Indicate mode [dSP \bar{n}]	Count chart		Operation
	In case of input mode is Up (Up, Up-1, Up-2)	In case of input mode is Down (Down, Down-1, Down-2)	
TOTAL [t σ tAL]			Count value increases or decreases until RESET input is applied. When input is over max./min. counting value, it displays 0. When Reset input is applied, it displays 0(Up)/999999(Down).
HOLD [H σ ld]			Count value increases or decreases until RESET input is applied. When input is reaching preset value(Up)/0(Down), the display value is hold. When Reset input is applied, it displays 0(Up)/preset value(Down).

- In case of the Command input [Ud-A], Individual input [Ud-b], Phase difference input [Ud-C] mode.

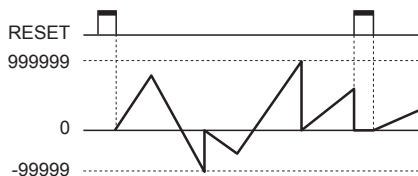

※In case of UP/DOWN [Ud-A, Ud-b, Ud-C] input mode, indication mode [dSP \bar{n}] of the configuration is not displayed.

Programmable Counter/Timer

Parameter Setting (Timer)

(MD) key: Moves the settings, (M), (N) key: Changes the settings

Parameter	Setting
Counter/Timer [C- <i>t</i>]	$C \leftrightarrow U \leftrightarrow T \leftrightarrow E$ <p>※C: Counter T: Timer</p>
Time range [Hour/Min/Sec]	<p>● 6-digit type</p> <p>● 4-digit type</p>
Up/Down mode [U-d]	$UP \leftrightarrow dn$ <p>※UP: Time progresses from '0' to the setting time. dn: Time progresses from the setting time to '0'.</p>
Indication mode [dSP, n]	$t \leftrightarrow RL \leftrightarrow Hold \leftrightarrow on t.d$ <p>※Used for the indicator type only. ※It is added that the feature which set the setting time when selecting Hold or on t.d</p>
Memory protection [dRA]	$CLr \leftrightarrow rEC$ <p>※Used for the indicator type only. ※CLr: Reset time value when power is off. rEC: Memorizes time value at the moment of power off.</p>
Output mode [oUt, n]	$ond \leftrightarrow ond.1 \leftrightarrow ond.2 \leftrightarrow FLt \leftrightarrow FLt.1 \leftrightarrow FLt.2 \leftrightarrow int$ <p>↑ intG ↔ nFd.1 ↔ nFd ↔ oFd ↔ int.2 ↔ int.1</p>
OUT2 output time [oUt 2] ^{*1}	<p>※Set one-shot output time of OUT2. ※Setting range: 00.01 to 99.99sec, Hold. ※When 1st digit is flashing, press the (M) key once and Hold appears.</p>
OUT1 output time [oUt 1] ^{*1}	<p>※Set one-shot output time of OUT1. ※Setting range: 00.01 to 99.99sec, Hold. ※When 1st digit is flashing, press the (M) key once and Hold appears.</p>
OUT output time [oUt t] ^{*1}	<p>※Setting range: 00.01 to 99.99sec, Hold. ※When 1st digit is flashing, press the (M) key once and Hold appears.</p>
Input logic [Si G]	<p>nPN: No-voltage input, PNP: Voltage input ※Check input logic value (PNP, NPN).</p>
Input signal time [i nt]	$I \leftrightarrow 20$, <p>※CTS/CTY: Set min. width of INA, INH, RESET signal. ※CTM: Set min. width of INA, RESET, INHIBIT, BATCH RESET signal.</p>
Key lock [LoCk]	$LoFF \leftrightarrow LoC.1$ <p>※LoFF: Unlock keys, key lock indicator turns OFF</p> <p>LoC.1: Locks (RST) key, key lock indicator turns ON</p> <p>LoC.2: Locks (M), (N), (N) keys, key lock indicator turns ON</p> <p>LoC.3: Locks (RST), (M), (N), (N) keys, key lock indicator turns ON</p>

*1: When output mode is FLt.1, FLt.2, intG and ond, ond.1, ond.2 of PRESET1 model, oUt 1 does not appear. The output time of oUt 2 is displayed as oUt t. When output mode is ond, ond.1, ond.2, int.2, oUt 1 appears.

*2: int.2 mode is available only for PRESET2 model.

- (A) Photoelectric Sensors
- (B) Fiber Optic Sensors
- (C) Door/Area Sensors
- (D) Proximity Sensors
- (E) Pressure Sensors
- (F) Rotary Encoders
- (G) Connectors/ Connector Cables/ Sensor Distribution Boxes/Sockets
- (H) Temperature Controllers
- (I) SSRs / Power Controllers
- (J) Counters
- (K) Timers
- (L) Panel Meters
- (M) Tacho / Speed / Pulse Meters
- (N) Display Units
- (O) Sensor Controllers
- (P) Switching Mode Power Supplies
- (Q) Stepper Motors & Drivers & Controllers
- (R) Graphic/ Logic Panels
- (S) Field Network Devices
- (T) Software

Output Operation Mode (Timer)

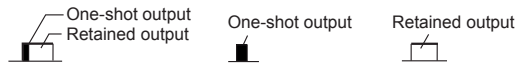

Output mode	Input mode	Operation
OND [OND]	Signal On Delay (Power Reset)	<ol style="list-style-type: none"> Time starts when INA signal turns on. When INA signal turns off, time resets. When INA signal is on: Power ON Time Start is operated Power OFF Time Start is operated Control output operates as retained or one-shot output. <p>T1: Setting time1 T2: Setting time2</p>
	Signal On Delay 1 (Power Reset)	<ol style="list-style-type: none"> Time starts when INA signal turns on, if INA signal is applied repeatedly, only initial signal is recognized. When INA signal is on: Power ON Time Start is operated Power OFF Time Start is operated Control output operates as retained or one-shot output. Only first INA input signal is valid in case INA input signal is repeatedly applied. <p>T1: Setting time1 T2: Setting time2</p>
OND.1 [OND.1]	Power On Delay (Power Hold)	<ol style="list-style-type: none"> Time starts when power turns on. (There is no INA function.) Time resets when reset turns on. Time starts when reset turns off. Control output operates as retained or one-shot output. It memorizes display value at the moment of power off. <p>T1: Setting time1 T2: Setting time2</p>
	Power On Delay 1 (Power Hold)	<ol style="list-style-type: none"> Time starts when INA signal turns on. When INA signal is on: Power ON Time Start is operated Power OFF Time Start is operated Control output operates as retained output, output turns off for the T.off time and turns on for the T.on time repeatedly. Ta+Tb = T.off setting time The T.on time and T.off time must be set individually. In case of using the contact output, min.setting time must be set over 100ms. <p>T.off: T.off setting time T.on: T.on setting time</p>
OND.2 [OND.2]	Flicker (Power Reset)	<ol style="list-style-type: none"> Time starts when INA signal turns on. When INA signal is on: Power ON Time Start is operated Power OFF Time Start is operated Control output operates as retained output, output turns off for the T.off time and turns on for the T.on time repeatedly. Ta+Tb = T.off setting time The T.on time and T.off time must be set individually. In case of using the contact output, min.setting time must be set over 100ms. <p>T.off: T.off setting time T.on: T.on setting time</p>
	FLK [FLK]	

※Power Reset: There is no memory protection. (Initializes the display value when power is off)
 Power Hold: There is memory protection. (Memorizes the display value at the moment of power off, indicates the memorized display value when power is resupplied.)

Programmable Counter/Timer

Output Operation Mode (Timer)

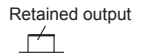
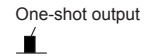
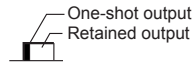

Output mode	Input mode	Operation
FLK.1 [FL E.1]	Flicker 1 (Power Reset)	<p>Operation</p> <ol style="list-style-type: none"> 1) Time starts when INA signal turns on. 2) When INA signal is on: Power ON Time Start is operated Power OFF Time Start is operated 3) Control output operates as retained output. 4) In case of using the contact output, min. setting time must be set over 100ms.
	One-Shot output	<p>Operation</p> <ol style="list-style-type: none"> 1) Time starts when INA signal turns on. 2) When INA signal is on: Power ON Time Start is operated Power OFF Time Start is operated 3) Control output operates as one-shot output. 4) In case of using the contact output, min. setting time must be set over 100ms.
	Flicker 2 (Power Hold)	<p>Operation</p> <ol style="list-style-type: none"> 1) Time starts when INA signal turns ON and the display value at the moment when power is off is memorized. 2) When INA signal is on: Power ON Time Start is operated Power OFF Time Start is operated 3) Control output operates as retained output. 4) Control output will be reversed when it reaches to setting time. (At the initial start, OUT2 control output is OFF). 5) In case of using the contact output, min. setting time must be set over 100ms.
	One-Shot output	<p>Operation</p> <ol style="list-style-type: none"> 1) Time starts when INA signal turns ON and the display value at the moment when power is off is memorized. 2) When INA signal is on: Power ON Time Start is operated Power OFF Time Start is operated 3) Control output operates as one-shot output. 4) In case of using the contact output, min. setting time must be set over 100ms.
FLK.2 [FL E.2]	Flicker 1 (Power Reset)	<p>Operation</p> <ol style="list-style-type: none"> 1) Time starts when INA signal turns on. 2) When INA signal is on: Power ON Time Start is operated Power OFF Time Start is operated 3) Control output operates as retained output. 4) In case of using the contact output, min. setting time must be set over 100ms.
	One-Shot output	<p>Operation</p> <ol style="list-style-type: none"> 1) Time starts when INA signal turns on. 2) When INA signal is on: Power ON Time Start is operated Power OFF Time Start is operated 3) Control output operates as one-shot output. 4) In case of using the contact output, min. setting time must be set over 100ms.
	Flicker 2 (Power Hold)	<p>Operation</p> <ol style="list-style-type: none"> 1) Time starts when INA signal turns ON and the display value at the moment when power is off is memorized. 2) When INA signal is on: Power ON Time Start is operated Power OFF Time Start is operated 3) Control output operates as retained output. 4) Control output will be reversed when it reaches to setting time. (At the initial start, OUT2 control output is OFF). 5) In case of using the contact output, min. setting time must be set over 100ms.
	One-Shot output	<p>Operation</p> <ol style="list-style-type: none"> 1) Time starts when INA signal turns ON and the display value at the moment when power is off is memorized. 2) When INA signal is on: Power ON Time Start is operated Power OFF Time Start is operated 3) Control output operates as one-shot output. 4) In case of using the contact output, min. setting time must be set over 100ms.

※ Power Reset: There is no memory protection. (Initializes the display value when power is off)

Power Hold: There is memory protection. (Memorizes the display value at the moment of power off, indicates the memorized display value when power is resupplied.)

- (A) Photoelectric Sensors
- (B) Fiber Optic Sensors
- (C) Door/Area Sensors
- (D) Proximity Sensors
- (E) Pressure Sensors
- (F) Rotary Encoders
- (G) Connectors/ Connector Cables/ Sensor Distribution Boxes/Sockets
- (H) Temperature Controllers
- (I) SSRs / Power Controllers
- (J) Counters
- (K) Timers
- (L) Panel Meters
- (M) Tacho / Speed / Pulse Meters
- (N) Display Units
- (O) Sensor Controllers
- (P) Switching Mode Power Supplies
- (Q) Stepper Motors & Drivers & Controllers
- (R) Graphic/ Logic Panels
- (S) Field Network Devices
- (T) Software

Output Operation Mode (Timer)

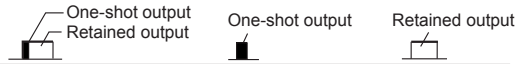

Output mode	Input mode	Operation
INT [1 n.t.]	Interval (Power Reset)	<p>1) Control output turns ON and time starts when INA signal turns ON.</p> <p>2) When INA signal is on: Power ON Time Start is operated Power OFF Time Start is operated</p> <p>3) When it reaches setting time, indication value and control output are reset automatically.</p> <p>4) Control output is ON when time is progressing.</p>
		<p>T: Setting time</p>
INT.1 [1 n.t. 1]	Interval 1 (Power Reset)	<p>1) Control output turns ON and time starts when INA signal turns ON.</p> <p>2) When INA signal is on: Power ON Time Start is operated Power OFF Time Start is operated</p> <p>3) When it reaches setting time, indication value and control output are reset automatically.</p> <p>4) Control output is ON when time is progressing.</p> <p>5) INA input is ignored while time is progressing.</p>
		<p>T: Setting time</p>
INT.2 [1 n.t. 2]	Interval 2 (Power Reset)	<p>1) Time starts when INA input is ON and resets when INA input is OFF.</p> <p>2) INA input is ON, OUT1 output is ON during T1 or t1.</p> <p>3) When it reaches setting time1, display value resets and OUT2 output is ON during T2 or t2 output time.</p> <p>※ Output turns OFF when reaching the setting time even if one-shot time is longer than setting time.</p>
		<p>T1: Setting time1 T2: Setting time2 t1: One-shot1 t2: One-shot2</p> <p>(PRESET1 model has no INT.2 mode)</p>

※Power Reset: There is no memory protection. (Initializes the display value when power is off)

Power Hold: There is memory protection. (Memorizes the display value at the moment of power off, indicates the memorized display value when power is resupplied.)

Programmable Counter/Timer

Output Operation Mode (Timer)



Output mode	Input mode	Operation
OFD [oFd]	Signal Off Delay1 (Power Reset)	<p>1) If INA is ON, control output remains ON. (except when power is off and reset is on) 2) When INA signal is OFF, time processes. 3) When it reaches setting time, indication value and control output are reset automatically.</p> <p>POWER INA INH RESET Setting time Display 0 Down Setting time 0 OUT2 (OUT)</p>
NFD [nFd]	On-Off Delay (Power Reset)	<p>1) When INA input is ON, output is ON and time is progressing, then output is OFF after On_Delay time. 2) When INA input is OFF, output is ON and time is progressing, then output is OFF after Off_Delay time. 3) If INA input is OFF within On_Delay time, step 2 starts again. 4) If INA input is ON within Off_Delay time, step 1 starts again.</p> <p>POWER INA (START) INH (INHIBIT) RESET On_Delay Off_Delay Display 0 Down Off_Delay 0 OUT2 (OUT)</p>
NFD.1 [nFd.1]	On-Off Delay1 (Power Hold)	<p>1) When INA input turns ON, time progresses and output turns ON after On_Delay time. 2) When INA input turns OFF, time progresses and output turns OFF after Off_Delay time. 3) If INA input turns OFF within On_Delay time, output will turn ON and step2 operate. 4) If INA input turns ON within Off_Delay time, output will turn OFF and step1 operate.</p> <p>POWER INA (START) INH (INHIBIT) RESET On_Delay Off_Delay Display Up Down Off_Delay Down On_Delay OUT2 (OUT)</p>
INTG [intG]	Integration Time (Power Reset)	<p>1) Time is progressing while INA input is ON. 2) Time progress stops while INA input is OFF. 3) When it reaches the setting time, output is ON.</p> <p>POWER INA (START) INH (INHIBIT) RESET Setting time Display 0 Down Setting time 0 OUT2 (OUT)</p>

- (A) Photoelectric Sensors
- (B) Fiber Optic Sensors
- (C) Door/Area Sensors
- (D) Proximity Sensors
- (E) Pressure Sensors
- (F) Rotary Encoders
- (G) Connectors/ Connector Cables/ Sensor Distribution Boxes/Sockets
- (H) Temperature Controllers
- (I) SSRs / Power Controllers
- (J) Counters
- (K) Timers
- (L) Panel Meters
- (M) Tacho / Speed / Pulse Meters
- (N) Display Units
- (O) Sensor Controllers
- (P) Switching Mode Power Supplies
- (Q) Stepper Motors & Drivers & Controllers
- (R) Graphic/ Logic Panels
- (S) Field Network Devices
- (T) Software

※Power Reset: There is no memory protection. (Initializes the display value and the output status when re-supplying the power.)
 Power Hold: There is memory protection. (It memorizes the status of power off. When re-supplying the power, it returns the memorized display value and the output status.)

■ Timer Operation of the Indicator (CT6S-I, CT6Y-I, CT6M-I)

TOTAL [t o t A L]	<p>When memory protection setting is OFF</p>	<ol style="list-style-type: none"> 1) Time starts when INA input is ON. 2) Setting value is initialized when Reset input is ON. 3) Time progress stops when INHIBIT input is ON. 4) Resets when power is OFF.
	<p>When memory protection setting is ON</p>	<ol style="list-style-type: none"> 1) Time starts when INA input is ON. 2) Setting value is initialized when Reset input is ON. 3) Time progress stops while INHIBIT input is ON. 4) Display value at the moment of power OFF is memorized.
HOLD [H o L d]	<p>When memory protection setting is OFF</p>	<ol style="list-style-type: none"> 1) Time progresses when INA input is ON. 2) Time progress stops while INA input is OFF. 3) When time reaches setting time, display value will stop and flash. 4) When reset input is applied, display value is initialized. 5) Resets when power is OFF.
	<p>When memory protection setting is ON</p>	<ol style="list-style-type: none"> 1) Time progresses when INA input is ON. 2) Time progress stops while INA input is OFF. 3) When time reaches setting time, display value will stop and flash. 4) When reset input is applied, display value is initialized. 5) Display value the moment when power is OFF is memorized.
On Time Display [o n t d]	<p>When memory protection setting is OFF</p>	<p>※ON time indicate mode of INA input</p> <ol style="list-style-type: none"> 1) Time reset start operates when INA input turns ON. 2) Time progress stops while INA input is OFF. 3) When time progress stops and power is off, the display value is initialized. 4) If progress time is greater than setting time when INA input turns off, display value flashes and operation stops until reset signal is applied.
	<p>When memory protection setting is ON</p>	<p>※ON time indicate mode of INA input</p> <ol style="list-style-type: none"> 1) Time reset start operates when INA input turns ON. 2) Time progress stops while INA input is OFF. 3) When time progress stops and power is off, the display value is memorized. 4) If progress time is greater than setting time when INA input turns off, display value flashes and operation stops until reset signal is applied.

Programmable Counter/Timer

■ Timer '0' Time Setting

◎ Available output operation mode to set '0' time setting

$ond, ond.1, ond.2, nfd, nfd.1$

◎ Operation according to output mode (at 0 time setting)

1) OND (Signal ON Delay) mode [ond]

● Setting time1 is set to 0

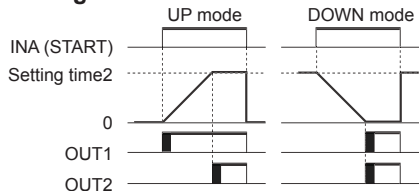

2) OND.1 (Signal ON Delay 1) mode [$ond.1$]

● Setting time1 is set to 0

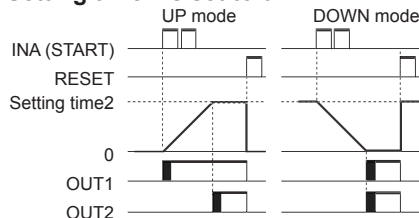

3) OND.2 (Power ON Delay2) mode [$ond.2$]

● Setting time1 is set to 0

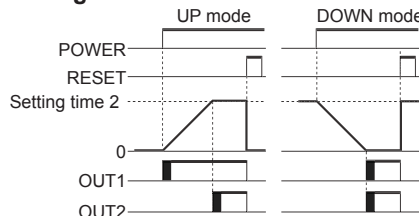

4) NFD (ON-OFF Delay) mode [nfd]

● OFF_Delay setting time is set to 0

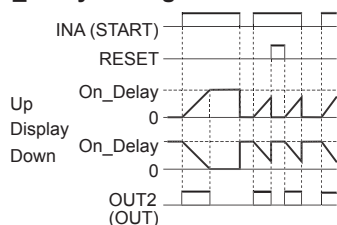

5) NFD.1 (ON-OFF Delay1) mode [$nfd.1$]

● OFF_Delay setting time is set to 0

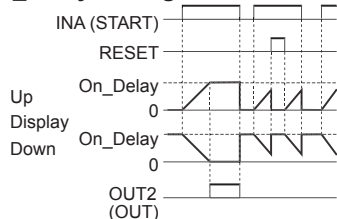

◎ Setting value1 (PS1) is higher than Setting value2 (PS2)

OND [ond], OND.1 [$ond.1$] or OND.2 [$ond.2$] output mode

● UP mode: When the timer setting value1 is greater than the setting value 2, OUT1 output does not turn ON.

● DOWN mode: When the timer setting value1 is greater than the setting value 2, OUT1 output does not turn ON.

If the setting value 1 is same as the setting value2 and START signal is applied, OUT1 output turns ON immediately.

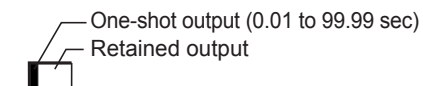

● Setting time2 is set to 0

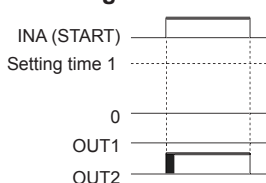

● Setting time2 is set to 0

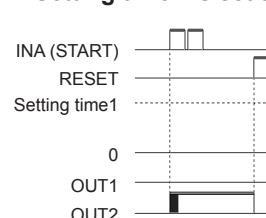

● Setting time2 is set to 0

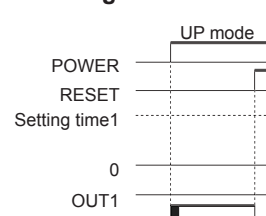

● ON_Delay setting time is set to 0

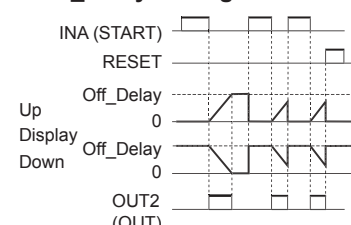

● ON_Delay setting time is set to 0

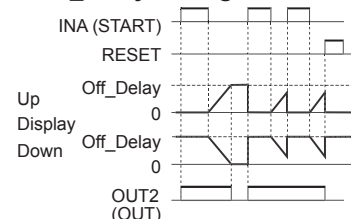

(A) Photoelectric Sensors

(B) Fiber Optic Sensors

(C) Door/Area Sensors

(D) Proximity Sensors

(E) Pressure Sensors

(F) Rotary Encoders

(G) Connectors/ Connector Cables/ Sensor Distribution Boxes/Sockets

(H) Temperature Controllers

(I) SSRs / Power Controllers

(J) Counters

(K) Timers

(L) Panel Meters

(M) Tacho / Speed / Pulse Meters

(N) Display Units

(O) Sensor Controllers

(P) Switching Mode Power Supplies

(Q) Stepper Motors & Drivers & Controllers

(R) Graphic/ Logic Panels

(S) Field Network Devices

(T) Software

Programmable Counter/Timer

Ⓞ Communication command and block

The format of query and response

1) Read coil status (func. 01 H), Read input status (func. 02 H)

• Query (master)

Slave Address	Function	Starting Address		No. of Points		Error Check (CRC 16)	
		High	Low	High	Low	Low	High
1Byte	1Byte	1Byte	1Byte	1Byte	1Byte	1Byte	1Byte

CRC 16

• Response (slave)

Slave Address	Function	Byte Count	Data			Error Check (CRC 16)	
			Low	High	Low	High	
1Byte	1Byte	1Byte	1Byte	1Byte	1Byte	1Byte	1Byte

CRC 16

2) Read holding registers (func. 03 H), Read input registers (func. 04 H)

• Query (master)

Slave Address	Function	Starting Address		No. of Points		Error Check (CRC 16)	
		High	Low	High	Low	Low	High
1Byte	1Byte	1Byte	1Byte	1Byte	1Byte	1Byte	1Byte

CRC 16

• Response (slave)

Slave Address	Function	Byte Count	Data			Error Check (CRC 16)	
			High	Low	High	Low	Low
1Byte	1Byte	1Byte	1Byte	1Byte	1Byte	1Byte	1Byte

CRC 16

3) Force single coil. (func. 05 H)

• Query (master)

Slave Address	Function	Coil Address		Force Data		Error Check (CRC 16)	
		High	Low	High	Low	Low	High
1Byte	1Byte	1Byte	1Byte	1Byte	1Byte	1Byte	1Byte

CRC 16

• Response (slave)

Slave Address	Function	Coil Address		Force Data		Error Check (CRC 16)	
		High	Low	High	Low	Low	High
1Byte	1Byte	1Byte	1Byte	1Byte	1Byte	1Byte	1Byte

CRC 16

4) Preset single register (func. 06 H)

• Query (master)

Slave Address	Function	Register Address		Preset Data		Error Check (CRC 16)	
		High	Low	High	Low	Low	High
1Byte	1Byte	1Byte	1Byte	1Byte	1Byte	1Byte	1Byte

CRC 16

• Response (slave)

Slave Address	Function	Register Address		Preset Data		Error Check (CRC 16)	
		High	Low	High	Low	Low	High
1Byte	1Byte	1Byte	1Byte	1Byte	1Byte	1Byte	1Byte

CRC 16

5) Preset multiple registers (func. 10 H)

• Query (master)

Slave Address	Function	Starting Address		No. of Register		Byte Count	Data		Data		Error Check (CRC 16)	
		High	Low	High	Low		High	Low	High	Low	Low	High
1Byte	1Byte	1Byte	1Byte	1Byte	1Byte	1Byte	1Byte	1Byte	1Byte	1Byte	1Byte	1Byte

CRC 16

• Response (slave)

Slave Address	Function	Starting Address		No. of Register		Error Check (CRC 16)	
		High	Low	High	Low	Low	High
1Byte	1Byte	1Byte	1Byte	1Byte	1Byte	1Byte	1Byte

CRC 16

6) Application

Read Coil Status (func. 01 H)

Master reads OUT2 000002 (0001H) to 000003 (0002H),
OUT1 output status (ON: 1, OFF: 0) from the Slave
(Address 01).

• Query (master)

Slave Address	Function	Starting Address		No. of Points		Error Check (CRC 16)	
		High	Low	High	Low	Low	High
01 H	01 H	00 H	01 H	00 H	02 H	EC H	0B H

On slave side OUT2 000003 (0002H): OFF,
OUT1 000002 (0001H): ON

• Response (slave)

Slave Address	Function	Byte Count	Data (00003 to 00001)		Error Check (CRC 16)	
			Low	High	Low	High
01 H	01 H	01 H	02 H	D0 H	49 H	

Read Input Register (Func. 04 H) Master reads preset
value 301004 (03EBH) to 301005 (03ECH) of counter/
timer, Slave (Address 15).

• Query (master)

Slave Address	Function	Starting Address		No. of Points		Error Check (CRC 16)	
		High	Low	High	Low	Low	High
0F H	04 H	03 H	EB H	00 H	02 H	00 H	95 H

In case that the present value is 123456 (0001 E240 H) in
slave side, 301004 (03EBH): E240 H, 301005 (03ECH):
0001H

• Response (slave)

Slave Address	Function	Byte Count	Data		Data		Error Check (CRC 16)	
			High	Low	High	Low	Low	High
0F H	04 H	04 H	E2 H	40 H	00 H	01 H	E2 H	28 H

(A) Photoelectric Sensors

(B) Fiber Optic Sensors

(C) Door/Area Sensors

(D) Proximity Sensors

(E) Pressure Sensors

(F) Rotary Encoders

(G) Connectors/ Connector Cables/ Sensor Distribution Boxes/ Sockets

(H) Temperature Controllers

(I) SSRs / Power Controllers

(J) Counters

(K) Timers

(L) Panel Meters

(M) Tacho / Speed / Pulse Meters

(N) Display Units

(O) Sensor Controllers

(P) Switching Mode Power Supplies

(Q) Stepper Motors & Drivers & Controllers

(R) Graphic/ Logic Panels

(S) Field Network Devices

(T) Software

© Modbus mapping table

1) Reset/Output

No. (Address)	Func.	Explanation	Setting range	Notice
000001 (0000)	01/05	Reset	0:OFF 1:ON	—
000002 (0001)	01	OUT2 output	0:OFF 1:ON	—
000003 (0002)	01	OUT1 output	0:OFF 1:ON	—
000004 (0003)	01	BATCH output	0:OFF 1:ON	For BATCH output model
000005 (0004)	01/05	BATCH resets	0:OFF 1:ON	For BATCH output model

2) Terminal input status

No. (Address)	Func.	Explanation	Setting range	Notice
100001 (0000)	02	INA input status	0:OFF 1:ON	Terminal input status
100002 (0001)	02	INB input status	0:OFF 1:ON	Terminal input status
100003 (0002)	02	INHIBIT input status	0:OFF 1:ON	Terminal input status
100004 (0003)	02	RESET input status	0:OFF 1:ON	Terminal input status
100005 (0004)	02	BATCH RESET input status	0:OFF 1:ON	Terminal input status

3) Product information

No. (Address)	Func.	Explanation	Notice
300001 to 300100	04	Reserved	—
300101 (0064)	04	Product number H	Model ID
300102 (0065)	04	Product number L	
300103 (0066)	04	Hardware version	—
300104 (0067)	04	Software version	—
300105 (0068)	04	Model no. 1	"CT"
300106 (0069)	04	Model no. 2	"6M"
300107 (006A)	04	Model no. 3	"-2"
300108 (006B)	04	Model no. 4	"PT"
300109 (006C)	04	Reserved	—
300110 (006D)	04	Reserved	—
300111 (006E)	04	Reserved	—
300112 (006F)	04	Reserved	—
300113 (0070)	04	Reserved	—
300114 (0071)	04	Reserved	—
300115 (0072)	04	Reserved	—
300116 (0073)	04	Reserved	—
300117 (0074)	04	Reserved	—
300118 (0075)	04	Coil Status Start Address	0000
300119 (0076)	04	Coil Status Quantity	—
300120 (0077)	04	Input Status Start Address	0000
300121 (0078)	04	Input Status Quantity	—
300122 (0079)	04	Holding Register Start Address	0000
300123 (007A)	04	Holding Register Quantity	—
300124 (007B)	04	Input Register Start Address	0064
300125 (007C)	04	Input Register Quantity	—

4) Monitoring data

No. (Address)	Func.	Explanation	Setting range	Notice		
301001 (03E8)	04	BA.O LED display status	0:OFF 1:ON	Bit 5		
		OUT2 LED display status	0:OFF 1:ON	Bit 6		
		OUT1 LED display status	0:OFF 1:ON	Bit 7		
		BA.S LED display status	0:OFF 1:ON	Bit 10		
		LOCK LED display status	0:OFF 1:ON	Bit 11		
		PS2 LED display status	0:OFF 1:ON	Bit 12		
		PS1 LED display status	0:OFF 1:ON	Bit 13		
		TMR LED display status	0:OFF 1:ON	Bit 14		
		CNT LED display status	0:OFF 1:ON	Bit 15		
		301002 (03E9)	04	Present value of BATCH counter	0 to 999999	For BATCH output model
		301003 (03EA)				
		301004 (03EB)	04	Present value of counter/timer	[Counter] 6digit type : -99999 to 999999	Use counter and timer in common
		301005 (03EC)			4digit type : -999 to 9999 [Timer]: Within time setting range	
		301006 (03ED)	04	Display unit	[Counter] : decimal point of display value [Timer] : Time range	Counter: 40058 Data Timer: 40102 Data
		301007 (03EE)	04	PS (2) setting value	[Counter] 6digit type : -99999 to 999999	Use counter and timer in common
301008 (03EF)	4digit type : -999 to 9999 [Timer]: Within time setting range					
301009 (03F0)	04	PS1 setting value	[Timer]: Within time setting range	Use counter and timer in common		
301010 (03F1)						
301011 (03F2)						
301012 (03F3)	04	Setting value of BATCH counter	0 to 999999	Use counter and timer in common		
301013 (03F4)	04	Checking the input logic	0: NPN, 1: PNP			

• Date format of 301001 (03E8) address bit

Bit	Explanation	Data	Bit	Explanation	Data
Bit0	—	0	Bit8	—	0
Bit1	—	0	Bit9	—	0
Bit2	—	0	Bit10	BA.S	0 or 1
Bit3	—	0	Bit11	Lock	0 or 1
Bit4	—	0	Bit12	PRESET2	0 or 1
Bit5	BA.O	0 or 1	Bit13	PRESET1	0 or 1
Bit6	OUT2	0 or 1	Bit14	TMR	0 or 1
Bit7	OUT1	0 or 1	Bit15	CNT	0 or 1

※2 Words data format: Upper data has high number address.

E.g.)301004: Present Value (Low Word),

301005: Present Value (High Word)

5) Preset value setting group

No. (Address)	Func.	Explanation	Setting range	Notice	
400001 (0000)	03/ 06/ 16	PS2 setting value	[Counter] 6digit type : 0 to 999999 4digit type: 0 to 9999 [Timer]: Within time setting range	Use counter and timer in common	
400002 (0001)					PS setting value
400003 (0002)		PS1 setting value			
400004 (0003)					
400005 (0004)		BATCH counter			0 to 999999
400006 (0005)		setting value			

Programmable Counter/Timer

6) Function setting mode (counter group)

No. (Address)	Func.	Explanation	Setting range	Notice
400051 (0032)	03/06/16	Counter/Timer [C - t]	1: C o U n 1: t i n E	Use counter and timer in common
400052 (0033)	03/06/16	Input mode [i n]	0: U P 5: d n - 2 1: U P - 1 6: U d - R 2: U P - 2 7: U d - b 3: d n 8: U d - C 4: d n - 1	—
400053 (0034)	03/06/16	Indication mode [d i S n]	0: t o t A L 1: H o L d	For the indicator
400054 (0035)	03/06/16	Output mode [o U t n]	0: F 3: r 6: 9 9: t 1: n 4: 2 7: R 10: d 2: C 5: P 8: 5	—
400055 (0036)	03/06/16	Maximum counting speed [C P S]	0: 1 2: 1 2 4: 1 0 2 1: 3 0 3: 5 2	—
400056 (0037)	03/06/16	OUT2 (OUT) output time [o U t 2 (o U t t)]	0 0 0 1 to 9 9 9 9	unit: ×10ms
400057 (0038)	03/06/16	OUT1 Output time [o U t 1]	0 0 0 1 to 9 9 9 9	unit: ×10ms
400058 (0039)	03/06/16	Decimal point [d P]	0: - - - - - 2: - - - - - 4: - - - - - 1: - - - - - 3: - - - - - 5: - - - - -	4digit type 0: - - - - 1: - - - - 2: - - - - 3: - - - -
400059 (003A)	03/06/16	Min. reset time [r S t]	0: 1 1: 2 0	unit: ms
400060 (003B)	03/06/16	Prescale decimal point position [S C L d]	0: - - - - - 3: - - - - - 5: - - - - - 2: - - - - - 4: - - - - -	4digit type 1: - - - - 2: - - - - 3: - - - -
400061 (003C)	03/06/16	Prescale value [S C L]	6digit type: 0 0 0 0 0 1 to 9 9 9 9 9 9	Connected with prescale decimal point position
400062 (003D)			4digit type: 0 0 0 1 to 9 9 9 9	
400063 (003E)	03/06/16	Start value [S t r t]	6digit type: 0 0 0 0 0 0 to 9 9 9 9 9 9	Connected with decimal point position of display value
400064 (003F)			4digit type: 0 0 0 0 to 9 9 9 9	
400065 (0040)	03/06/16	Memory protection [d R t R]	0: C L r 1: r E C	Use counter and timer in common
400066 (0041)	03/06/16	Lock key [L o C k]	0: L o F F 1: L o C . 1 2: L o C . 2 3: L o C . 3	

7) Function setting mode (timer group)

No. (Address)	Func.	Explanation	Setting range	Notice
400101 (0064)	03/06/16	Counter/Timer [C - t]	0: C o U n 1: t i n E	Use counter and timer in common
400102 (0065)	03/06/16	Time range [H o U r / m i n / S E C]	4digit type 0: 0.001s to 9.999s 5: 0.1m to 999.9m 1: 0.01s to 99.99s 6: 1m to 9999m 2: 0.1s to 999.9s 7: 1m to 99h59m 3: 1s to 9999s 8: 1h to 9999h 4: 1s to 99m59s	—
			6digit type 0: 0.001s to 999.999s 6: 1s to 9999m59s 1: 0.01s to 9999.99s 7: 1m to 99999.9m 2: 0.1s to 99999.9s 8: 1m to 999999m 3: 1s to 999999s 9: 1s to 99h59m59s 4: 0.01s to 99m59.99s 10: 1m to 9999h59m 5: 0.1s to 999m59.9s 11: 0.1h to 99999.9h	
400103 (0066)	03/06/16	UP/Down mode [U - d]	0: U P 1: d n	—
400104 (0067)	03/06/16	Output mode [o U t n]	0: o n d 3: F L 2 7: i n t . 1 10: n F d 1: o n d . 1 4: F L 2 . 1 8: i n t . 2 11: n F d . 1 2: o n d . 2 5: F L 2 . 2 9: o F d 12: i n t . 0	—
400105 (0068)	03/06/16	OUT2 (OUT) Output time [o U t 2]	0 0 0 0 to 9 9 9 9 (0: Hold)	unit: ×10ms
400106 (0069)	03/06/16	OUT1 Output time [o U t 1]	0 0 0 0 to 9 9 9 9 (0: Hold)	unit: ×10ms
400107 (006A)	03/06/16	Input signal time [i n t]	0: 1 1: 2 0	unit: ms
400108 (006B)	03/06/16	Memory protection [d R t R]	0: C L r 1: r E C	Use counter and timer in common
400109 (006C)	03/06/16	Lock key [L o C k]	0: L o F F 1: L o C . 1 2: L o C . 2 3: L o C . 3	Use counter and timer in common
400110 (006D)	03/06/16	Indication mode [d S P n]	0: t o t A L 1: H o L d 2: o n t d	For the indicator

(A) Photoelectric Sensors

(B) Fiber Optic Sensors

(C) Door/Area Sensors

(D) Proximity Sensors

(E) Pressure Sensors

(F) Rotary Encoders

(G) Connectors/ Connector Cables/ Sensor Distribution Boxes/Sockets

(H) Temperature Controllers

(I) SSRs / Power Controllers

(J) Counters

(K) Timers

(L) Panel Meters

(M) Tacho / Speed / Pulse Meters

(N) Display Units

(O) Sensor Controllers

(P) Switching Mode Power Supplies

(Q) Stepper Motors & Drivers & Controllers

(R) Graphic/ Logic Panels

(S) Field Network Devices

(T) Software

8) Function setting mode (communication group)

No. (Address)	Func.	Explanation	Setting range	Notice
400151 (0096)	03/06/16	Comm. address [R d d r]	1 to 127	—
400152 (0097)	03/06/16	Comm. speed [b P 5]	0: 24 1: 48 2: 96 3: 192 4: 384	unit: ×100bps
400153 (0098)	03/06/16	Comm. parity [P r t y]	0: n o n E 1: E u E n 2: o d d	—
400154 (0099)	03/06/16	Stop bit [5 t P]	0: 1 1: 2	—
400155 (009A)	03/06/16	Response waiting time [r 5 t t]	05 to 99	unit: ms
400156 (009B)	03/06/16	Comm. writing [C o n t]	0: E n R 1: d i 5 R	—

⊙ Exception processing

When communication error occurs, the highest bit of received function is set to 1, then sends response command and transmits exception code.

Slave Address	Function + 80H	Exception Code	Error Check (CRC16)	
			Low	High
1Byte	1Byte	1Byte	1Byte	1Byte

- Illegal Function (Exception Code: 01H): Not supporting command
- Illegal Data Address (Exception Code: 02H)
: Mismatch between the number of asked data and the number of anmittable data.
- Illegal Data Value (Exception Code: 03)
: Mismatch between asked the number of data and transmittable the number of data in device
- Slave Device Failure (Exception Code: 04H): Command is processed incorrectly.

Example)

Master reads output status (ON:1, OFF:0) of non existing coil 01001 (03E8 H) from Slave (Address17).

• Query (master)

Slave Address	Function	Starting Address		No. of Points		Error Check (CRC16)	
		High	Low	High	Low	Low	High
11H	01H	03H	E8H	00H	01H	##H	##H

• Response (slave)

Slave Address	Function + 80H	Exception Code	Error Check (CRC16)	
			Low	High
11H	81H	02H	##H	##H

■ Read and Write of Parameter Value Using Communication

⊙ Read of the parameter area

000002 (OUT2), 000003 (OUT1), 000004 (BA, 0), 100001 to 100005 (terminal input), 300101 to 300125 (product information), 301001 to 301013 (Monitoring data)

⊙ Read and write of the parameter area

000001 (reset starts), 000005 (BATCH reset starts), 400001 to 400006 (setting value saving group), 400051 to 400066 (counter setting group), 400101 to 400110 (timer setting group), 400151 to 400156 (communication setting group)

⊙ Read of communication

Read parameter value using communication. (function: 01H, 02H, 03H, 04H)

It is able to read communication regardless of permitting/prohibiting communication writing.

⊙ Communication write

Change parameter value using communication. (function: 05H, 06H, 10H)

- When changing the parameter setting value of 'Function setting mode Counter group' or 'Function setting mode Timer group' using communication, reset indication will flash in 3 sec and display value will be reset. (counting display value and progress time before changing parameter setting value are not saved.)
- When changing the parameter setting value of 'Preset value setting group' or 'Function setting mode Communication group' using communication, counting display value or progress time will not be reset.
- In prohibit writing communication setting (C o n t = 1: d i 5 R), a write command does not process.
- If setting value beyond the setting range, this setting value is substituted for the value within the setting range and then memorized.

Programmable Counter/Timer

■ Factory Default

	Parameter	Factory default
Counter	ln	Ud-C
	oUt.n	F
	dSP.n	totRL
	CP5	30
	oUt2(oUt.t)	Hold (fixed)
	oUt1	00.10
	dP	-----
	rSt	20
	SiG	nPn
	SC.dP	6-digit type: - - - - - 4-digit type: - - - -
	SC.L	6-digit type: 1.00000 4-digit type: 1.0000
St.r.t	000000	
dR.t.R	CLr	
Timer	HoUr/n/n/5EC	6-digit type: 0.001s-999.999s 4-digit type: 0.001s-9.999s
	U-d	UP
	dSP.n	totRL
	dR.t.R	CLr
	oUt.n	oNd
	oUt2(oUt.t)	HoLd
	oUt1	00.10
	SiG	nPn
General	Ln.t	20
	LoC.t	LoFF
	PS1	1000
Comm.	PS2	5000
	Addr	001
	bPS	96
	Pr.t.Y	nOnE
	St.P	2
	rSt.t	20
Co.n.Y	EnR	

■ Cautions during Use

- Follow instructions in 'Cautions during Use'. Otherwise, it may cause unexpected accidents.
- 24-48VDC, 24VAC power supply should be insulated and limited voltage/current or Class 2, SELV power supply device.
- Use the product, 0.1 sec after supplying power.
- When supplying or turning off the power, use a switch or etc. to avoid chattering.
- Install a power switch or circuit breaker in the easily accessible place for supplying or disconnecting the power.
- In case of contact input, set count speed to low speed mode (1cps or 30cps) to operate.
If set to high speed mode (1k, 5k, 10kcps), counting error occurs due to chattering.
- Keep away from high voltage lines or power lines to prevent inductive noise.
In case installing power line and input signal line closely, use line filter or varistor at power line and shielded wire at input signal line.
Do not use near the equipment which generates strong magnetic force or high frequency noise.
- This product may be used in the following environments.
 - Indoors (in the environment condition rated in 'Specifications')
 - Altitude max. 2,000m
 - Pollution degree 2
 - Installation category II

(A)	Photoelectric Sensors
(B)	Fiber Optic Sensors
(C)	Door/Area Sensors
(D)	Proximity Sensors
(E)	Pressure Sensors
(F)	Rotary Encoders
(G)	Connectors/ Connector Cables/ Sensor Distribution Boxes/Sockets
(H)	Temperature Controllers
(I)	SSRs / Power Controllers
(J)	Counters
(K)	Timers
(L)	Panel Meters
(M)	Tacho / Speed / Pulse Meters
(N)	Display Units
(O)	Sensor Controllers
(P)	Switching Mode Power Supplies
(Q)	Stepper Motors & Drivers & Controllers
(R)	Graphic/ Logic Panels
(S)	Field Network Devices
(T)	Software