

# Autonics Fiber Optic Amplifier BF4 SERIES INSTRUCTION MANUAL



Thank you for choosing our Autonics products. Please read the following safety considerations before use.

## Safety Considerations

- ⚠ Please observe all safety considerations for safe and proper product operation to avoid hazards.
- ⚠ symbol represents caution due to special circumstances in which hazards may occur.
- Warning** Failure to follow these instructions may result in serious injury or death.
- Caution** Failure to follow these instructions may result in personal injury or product damage.

### Warning

- Fail-safe device must be installed when using the unit with machinery that may cause serious injury or substantial economic loss.** (e.g. nuclear power control, medical equipment, ships, vehicles, railways, aircraft, combustion apparatus, safety equipment, crane/disaster prevention devices, etc.) Failure to follow this instruction may result in fire, personal injury, or economic loss.
- Install the unit on device panel or DIN rail to use.** Failure to follow this instruction may result in fire.
- Do not connect, repair, or inspect the unit while connected to a power source.** Failure to follow this instruction may result in fire.
- Check 'Connections' before wiring.** Failure to follow this instruction may result in fire.
- Do not disassemble or modify the unit.** Failure to follow this instruction may result in fire.

### Caution

- Use the unit within the rated specifications.** Failure to follow this instruction may result in fire or product damage.
- Use dry cloth to clean the unit, and do not use water or organic solvent.** Failure to follow this instruction may result in fire.
- Do not use the unit in the place where flammable/explosive/corrosive gas, humidity, direct sunlight, radiant heat, vibration, impact, or salinity may be present.** Failure to follow this instruction may result in fire or explosion.

## Unit Description

- Standard type (BF4R/BF4RP/BF4G/BF4GP)
- Remote sensitivity setting type (BF4-E)
- External synchronization input type (BF4-R)

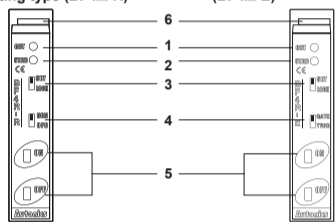

- Control output indicator (red):** Turns ON or OFF by control output status.
- Stability indicator (green):** Turns ON at stable light ON/OFF level.
- Mode setting switch - SET:** Set the switch to [SET] to use set the function.
- Lock lever:** Used for connecting fiber optic cable.
- Timer setting switch (standard type, remote sensitivity setting type)**
  - NON: Set the switch to [NON] not to use timer function.
  - OFD: Set the switch to [OFD] to use OFF Delay timer function.
- External synchronization setting switch (external synchronization input type)**
  - TRIG: Set the switch to [TRIG] to use external synchronization as trigger synchronization.
  - GATE: Set the switch to [GATE] to use external synchronization as gate synchronization.
- Sensitivity setting button:** Used for sensitivity setting
- Lock lever:** Used for connecting fiber optic cable.

## Function

### Sensitivity setting

Before sensitivity setting, install the fiber optic cable. After completing the setting, do not move or bend the fiber optic cable. If not, it may cause incorrect detection.

#### Adjustment by the sensitivity setting button (common)

##### Light ON

- Change the mode setting switch to [SET].
- Diffuse reflective: Press the [ON] button with a sensing target.
- Through-beam: Press the [ON] button without sensing target.

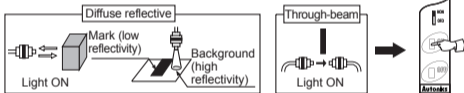

- The stability indicator [STAB] (green) flashes at ON state (check the target position).
- Diffuse reflective: Press the [OFF] button without a sensing target.
- Through-beam: Press the [OFF] button with a sensing target.

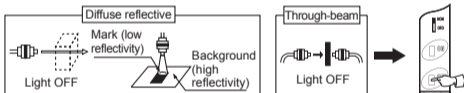

- When there is enough sensitivity difference between ON and OFF state, the stability indicator [STAB] flashes one time only at stable sensing level.
- When there is not enough sensitivity difference between ON and OFF state, the stability indicator [STAB] flashes five times at unstable sensing level.
- The sensitivity can be set at unstable sensing area.
- Change the mode selection switch to [LOCK] to fix the set sensitivity.

##### Dark ON

- The setting order are same as Light ON mode except ② & ③. The ③ & ④ order is opposite from Light ON.
- Diffuse reflective: Press the [ON] button without a sensing target.
- Through-beam: Press the [ON] button with a sensing target.
- Diffuse reflective: Press the [OFF] button with a sensing target.
- Through-beam: Press the [OFF] button without a sensing target.

#### Setting as max. sensitivity (common)

- Set the mode setting switch to [SET].
- Light ON:** Press the [ON] to [OFF] button without the sensing target. (or set ON input for remote sensitivity setting to Low level, and then set OFF input for remote sensitivity setting to Low level)
- Dark ON:** Press the [OFF] to [ON] button without the sensing target. (or set OFF input for remote sensitivity setting to Low level, and then set ON input for remote sensitivity setting to Low level)
- Set the mode setting switch to [LOCK].

#### Remote Sensitivity setting (BF4-E)

Remote sensitivity setting type, BF4-E can adjust the sensitivity with input signal lines without the mode setting switch.

- Light ON**
  - ON input of remote sensitivity setting (SW1): Turn ON the SW1 and then turn OFF it instead of ③ state of adjustment by the sensitivity setting button.
  - OFF input of remote sensitivity setting (SW2): Turn ON the SW2 and then turn OFF it instead of ③ state of adjustment by the sensitivity setting button.
- Dark ON**
  - OFF input of remote sensitivity setting (SW2): Turn ON the SW2 and then turn OFF it instead of ③ state of adjustment by the sensitivity setting button.
  - ON input of remote sensitivity setting (SW1): Turn ON the SW1 and then turn OFF it instead of ③ state of adjustment by the sensitivity setting button.

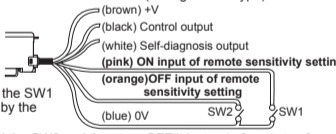

#### Self-diagnosis output (answer back) function (BF4-E)

When ON or OFF input of remote sensitivity setting is applied, after 300ms self-diagnosis output turns on for 40ms and then the sensor keeps normal sensing state. (refer to time chart)

Self-diagnosis output does not turn ON if there is no difference of sensitivity between ON input and OFF input and stable sensing is not excited, but stable sensing operates after 340ms.

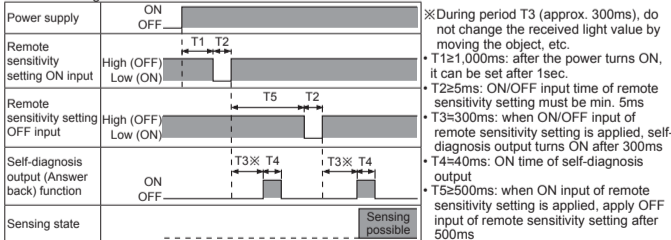

#### Timer (OFF Delay) function (BF4R/BF4G/BF4RP/BF4GP/BF4-E)

Standard type and Remote sensitivity setting type both contain the built-in OFF Delay timer, approx. 40ms. The timer works when the timer setting switch is set to [OFD]. The output turns off after remaining for additional 40ms at OFF position of the sensing output. It is useful when the response time of the connected device is slow when the sensing signal from a tiny object is too short.

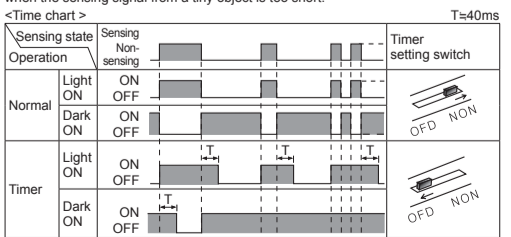

⚠ The above specifications are subject to change and some models may be discontinued without notice. ⚠ Be sure to follow cautions written in the instruction manual and the technical descriptions (catalog, homepage).

## Specifications

Type	Standard type				External synchronization input type		Remote sensitivity setting type	
Model	BF4RP	BF4GP	BF4R	BF4G	BF4R-E	BF4G-E	BF4R-R	BF4G-R
Light source (modulated light)	Red	Green	Red	Green	Red	Green	Red	Green
Power voltage	12-24VDC ±10% (Ripple P-P: Max. 10%)							
Current consumption	Max. 45mA							
Operation mode	Light ON/Dark ON switching							
Control output	NPN or PNP open collector output • Load voltage: Max. 30VDC • Load current: 100mA • Residual voltage - NPN: Max. 1V (load current: 100mA), Max. 0.4V (load current: 16mA) / PNP: Max. 2.5V							
Protection circuit	Power reverse polarity protection circuit, output short over current protection circuit							
Response frequency	Max. 0.5ms (frequency 1), Max. 0.7ms (frequency 2)							
Sensitivity setting	Sensitivity setting button (ON/OFF)							
Indicator	Control output indicator (OUT): Red LED, Stability indicator (STAB): Green LED (turns ON at stable light ON/OFF level)							
Interference prevention function	Built-in differential frequency mode (frequency 1 (normal mode): max. 0.5ms, frequency 2: max. 0.7ms)							
Self-diagnosis output	ON state under unstable sensing (when the target stays for 300ms in unstable level), ON state when control output is short-circuited • Load voltage: Max. 30VDC • Load current: 50mA • Residual voltage - NPN: Max. 1V (load current: 50mA), Max. 0.4V (load current: 16mA) / PNP: Max. 2.5V							
Input stop transmission function	—				Built in			
External synchro. function	—				Built in (Gate/Trigger)			
Remote sensitivity setting function	—				Built in			
Timer function	OFF delay (40ms)				—			
Insulation resistance	Over 20MΩ (at 500VDC megger)							
Noise immunity	±240V the square wave noise (pulse width: 1μs) by the noise simulator							
Dielectric strength	1,000VAC 50/60Hz for 1 minute							
Vibration	1.5mm amplitude at frequency of 10 to 55Hz in each X, Y, Z direction for 2 hours							
Shock	500ms <sup>2</sup> (approx. 50G) in each X, Y, Z direction for 3 times							
Environment	Ambient illum.: Sunlight: Max. 11,000lx, Incandescent lamp: Max. 3,000lx (receiver illumination) Ambient temp.: -10 to 50°C, storage: -20 to 70°C Ambient humi.: 35 to 85%RH, storage: 35 to 85%RH							
Material	Case: Heat-resistant ABS, Cover: Polycarbonate							
Cable	Ø4mm, 4-wire, 2m (AWG22, Core diameter: 0.08mm, Number of cores: 60, Insulator diameter: Ø1.25mm)				Ø4mm, 6-wire, 2m (AWG24, Core diameter: 0.08mm, Number of cores: 40, Insulator diameter: Ø1mm)			
Accessory	Mounting bracket, Bolts/nuts							
Approval	CE							
Weight*	Approx. 120g (approx. 65g)							

\*1: The weight includes packaging. The weight in parenthesis is for unit only.  
\*The temperature or humidity mentioned in Environment indicates a non freezing or condensation environment.

### External synchronization input function (BF4-E)

By using external synchronization function, the time for making sensing can be specified by external synchronization (trigger synchronization and gate synchronization).

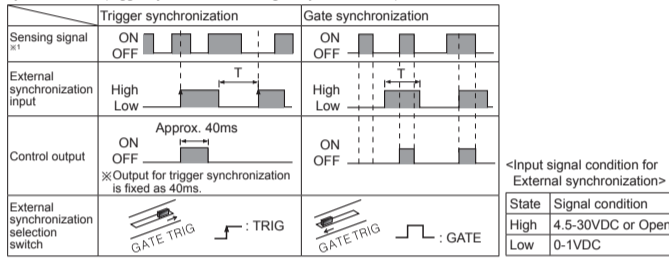

\*1: Right before transfer detection signal of the sensor as control output.  
\*T≥0.5ms (using interference prevention function: T≥0.7ms)

### Stop transmission function (BF4-E)

This function is available under light ON state only and it is for checking normal state of the sensor.

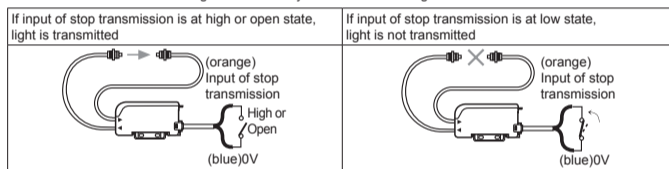

\*1: Transmission area  
\*2: Stop transmission area  
\*1: If transmission is stopped, control output must turn on, but if control output does not turn on, it seems that sensor has some problems.  
\*T≥0.5ms (when using interference prevention function T≥0.7ms)

### Self-diagnosis function (common)

When fiber hood is contaminated by dust, transmitted light is lowered by element ability loss or received light is lowered by missing of optical axis, the self-diagnosis output will turn on.

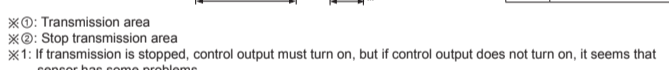

When detecting state remains over 300ms at unstable light ON/OFF level, the self diagnosis output turns ON. In case of stable light ON/OFF level, the self diagnosis output turns OFF. (① position)

### Interference prevention function (common)

BF4 series has interference prevention function, two fiber optic cables can be mounted very closely by setting different transmission frequencies.

#### Interference prevention function (operation of differential frequency mode)

First sensor - Frequency 1 (response time: max. 0.5ms) First sensor - Frequency 2 (response time: max. 0.7ms)

- Set the mode setting switch to [SET].
- Press the [ON] + [OFF] buttons for 2 sec. at the same time.
- The stability indicator [STAB] flashes continuously.
- Press the [ON] button.
- The stability indicator [STAB] turns OFF.

- Set the mode setting switch to [SET].
- Press the [ON] + [OFF] buttons for 2 sec. at the same time.
- The stability indicator [STAB] flashes continuously.
- Press the [OFF] button.
- The stability indicator [STAB] turns off.

- Set the mode setting switch to [LOCK].
- Set the mode setting switch to [LOCK].

### Mode Setting

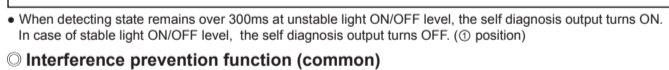

## Dimensions

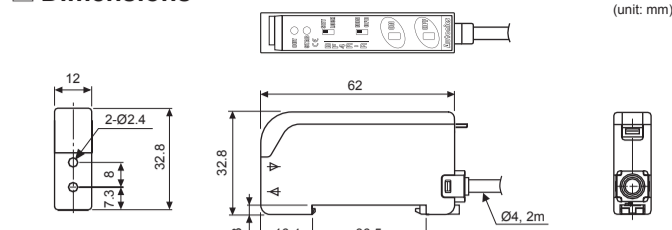

### Bracket

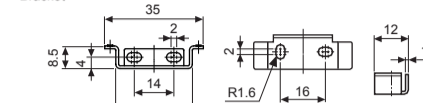

## Connections

### BF4R / BF4G

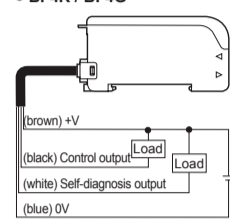

### BF4RP / BF4GP

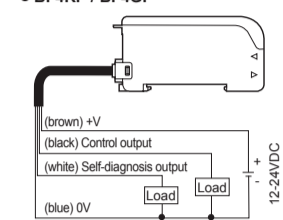

### BF4-E

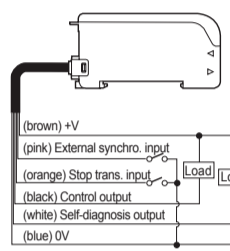

### BF4-R

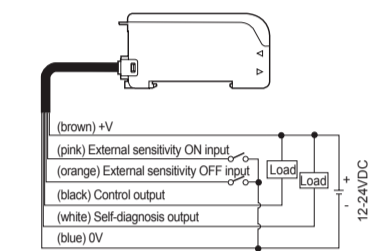

## Control Output Circuit Diagram

### NPN open collector output

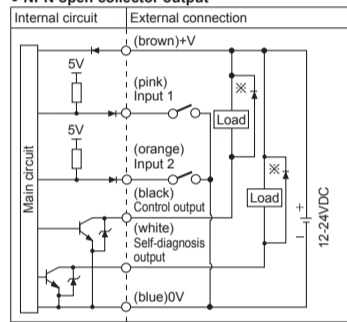

### PNP open collector output

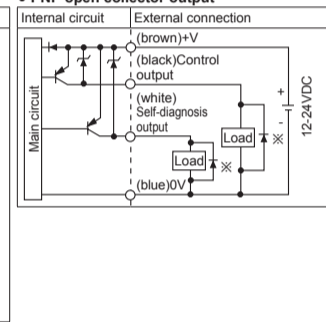

\*Connect diode at external terminal for inductive load.

Model	BF4R/BF4RP/BF4G/BF4GP	BF4-E (external synchronization input type)	BF4-R (remote sensitivity setting type)
Input cable	(standard type)	External synchronization input	ON input of external sensitivity setting
Input 1	—	External synchronization input	ON input of external sensitivity setting
Input 2	—	Emission disable input	OFF input of external sensitivity setting

## Installations

### Mounting/Removing amplifier unit

- Hook the front part of the amplifier on DIN rail. Press the rear part of the amplifier on DIN rail.
- Push the back of amplifier toward ① and lift the hole for fiber toward ② then simply take it out without tools.

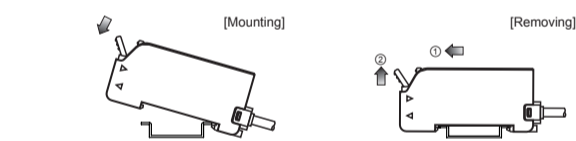

### Installation of fiber optic cable

- Lift up the protective cover to the ① direction to release the lock setting.
- Insert the cable to the ② direction and adhere between the cable and the inside of the amplifier unit. (insert depth: approx. 10mm)
- Place up the lock lever to ③ direction to lock the lock setting and close the protective cover.

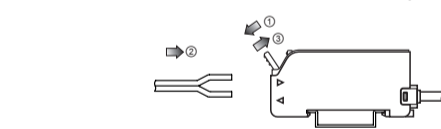

## Caution during Use

- Follow instructions in 'Cautions during Use'. Otherwise, it may cause unexpected accidents.
- 12-24VDC power supply should be insulated and limited voltage/current or Class 2, SELV power supply device.
- When connecting DC relay or other inductive load to the output, remove surge by using diode or varistor.
- Wire as short as possible and keep away from high voltage lines or power lines, to prevent surge and inductive noise.
- Use the product, after 3 sec of supplying power.
- When using switching mode power supply to supply power, ground F.G. terminal and connect a condenser between 0V and F.G. terminal to remove noise.
- Since external disturbance light (sunlight, fluorescent lighting, etc.) can cause product malfunction, use the product with a light shield or slit.
- When sensing an object with the maximum sensitivity, sensing distance error can occur due to deviation of each feature.
- When installing the fiber optic cable, refer to the radius of allowable stress for bending written in the catalogue. If installing the fiber optic cable under the rated radius of allowable stress for bending, light extinction occurs and sensing distance is shortened.
- Be cautious that a cross section of the fiber optic cable not be scratched.
- Do not pull the cable, when the fiber optic cable is connected to an amplifier unit.
- This unit may be used in the following environments.
  - Indoors (in the environment condition rated in 'Specifications')
  - Altitude max. 2,000m
  - Pollution degree 2
  - Installation category III

## Major Products

- Photoelectric Sensors
- Fiber Optic Sensors
- Door Sensors
- Door Side Sensors
- Area Sensors
- Proximity Sensors
- Pressure Sensors
- Rotary Encoders
- Connector/Sockets
- Switching Mode Power Supplies
- Control Switches/Lamps/Buzzers
- I/O Terminal Blocks & Cables
- Stepper Motors/Drivers/Motion Controllers
- Graphic/Logic Panels
- Field Network Devices
- Laser Marking System (Fiber, CO<sub>2</sub>, Nd: YAG)
- Laser Welding/Cutting System
- Temperature Controllers
- Temperature/Humidity Transducers
- SSRs/Power Controllers
- Counters
- Timers
- Panel Meters
- Tachometer/Pulse (Rate) Meters
- Display Units
- Sensor Controllers

**Autonics Corporation**  
http://www.autonics.com

HEAD QUARTERS:  
18, Bansong-ro 513beon-gil, Haendae-gu, Busan,  
South Korea, 48002  
TEL: 82-51-519-3232  
E-mail: sales@autonics.com