

Autonics

**INDUCTIVE PROXIMITY SENSOR
(CYLINDRICAL METAL AC CONNECTOR TYPE)
PRCM SERIES
INSTRUCTION MANUAL**



Thank you for choosing our Autonics product.
Please read the following safety considerations before use.

■ Safety Considerations

※Please observe all safety considerations for safe and proper product operation to avoid hazards.
※⚠ symbol represents caution due to special circumstances in which hazards may occur.

⚠ Warning Failure to follow these instructions may result in serious injury or death.

⚠ Caution Failure to follow these instructions may result in personal injury or product damage.

⚠ Warning

- Fail-safe device must be installed when using the unit with machinery that may cause serious injury or substantial economic loss.** (e.g. nuclear power control, medical equipment, ships, vehicles, railways, aircraft, combustion apparatus, safety equipment, crime/disaster prevention devices, etc.)
Failure to follow this instruction may result in fire, personal injury, or economic loss.
- Do not disassemble or modify the unit.**
Failure to follow this instruction may result in electric shock or fire.
- Do not connect, repair, or inspect the unit while connected to a power source.**
Failure to follow this instruction may result in electric shock or fire.
- Check 'Connections' before wiring.**
Failure to follow this instruction may result in fire.

⚠ Caution

- Use the unit within the rated specifications.**
Failure to follow this instruction may result in fire or product damage.
- Use dry cloth to clean the unit, and do not use water or organic solvent.**
Failure to follow this instruction may result in electric shock or fire.
- Do not use the unit in the place where flammable/explosive/corrosive gas, humidity, direct sunlight, radiant heat, vibration, impact, or salinity may be present.**
Failure to follow this instruction may result in fire or explosion.
- Do not supply power without load.**
Failure to follow this instruction may result in fire or product damage.

■ Ordering Information

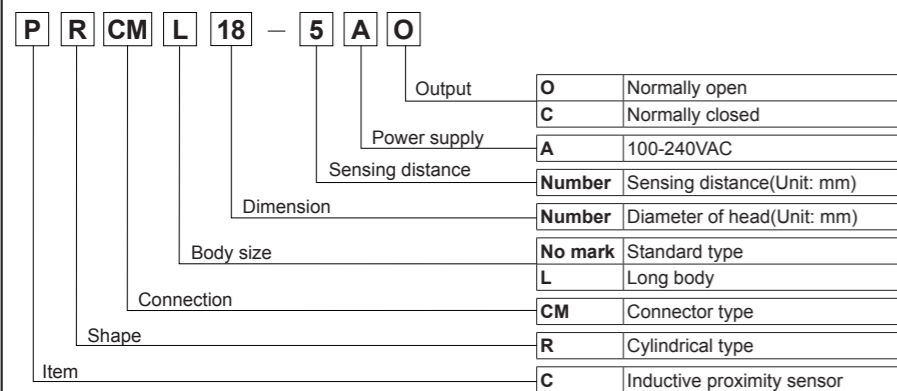

■ Control Output Diagram & Load Operating

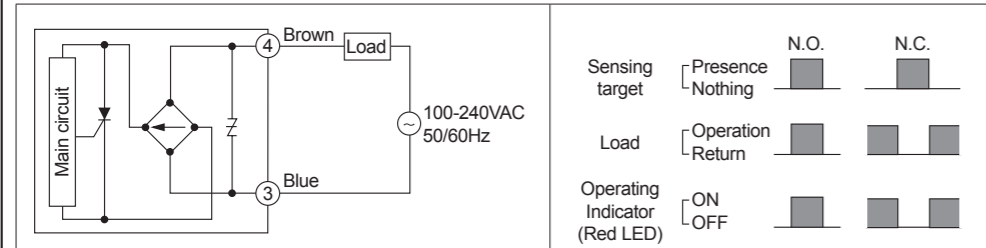

※The above specifications are subject to change and some models may be discontinued without notice.
※Be sure to follow cautions written in the instruction manual and the technical descriptions (catalog, homepage).

■ Specifications

Model	PRCM12-2AO PRCM12-2AC	PRCM12-4AO PRCM12-4AC	PRCM18-5AO PRCM18-5AC PRCML18-5AO PRCML18-5AC	PRCM18-8AO PRCM18-8AC PRCML18-8AO PRCML18-8AC	PRCM30-10AO PRCM30-10AC PRCML30-10AO PRCML30-10AC	PRCM30-15AO PRCM30-15AC PRCML30-15AO PRCML30-15AC
Sensing distance	2mm	4mm	5mm	8mm	10mm	15mm
Hysteresis	Max. 10% of sensing distance					
Standard sensing target	12×12×1mm(Iron)		18×18×1mm (Iron)	25×25×1mm (Iron)	30×30×1mm (Iron)	45×45×1mm (Iron)
Setting distance	0 to 1.4mm	0 to 2.8mm	0 to 3.5mm	0 to 5.6mm	0 to 7mm	0 to 10.5mm
Power supply (Operating voltage)	100-240VAC~ 50/60Hz(85-264VAC~)					
Leakage current	Max. 2.5mA					
Response frequency*1	20Hz					
Residual voltage	Max. 10V					
Affection by Temp.	When it is 20°C at the rated ambient temperature, it is below 10%					
Control output	5 to 150mA		5 to 200mA			
Insulation resistance	Min. 50MΩ(at 500VDC megger)					
Dielectric strength	2,500VAC 50/60Hz for 1minute					
Vibration	1mm amplitude at frequency of 10 to 55Hz in each of X, Y, Z directions for 2 hours					
Shock	500m/s ² (approx. 50G) X, Y, Z directions for 3 times					
Indicator	Operating indicator : Red LED					
Environ -ment	Ambient temperature		-25 to 70°C, Storage: -30 to 80°C			
	Ambient humidity		35 to 95%RH, Storage: -30 to 95%RH			
Protection circuit	Surge protection circuit					
Protection	IP67(IEC standards)					
Insulation type	Double insulation or reinforced insulation (Mark: □, dielectric strength between the measuring input part and the power part: 1kV)					
Material	Case and nut: Nickel-plated brass, Washer: Nickel-plated steel, Sensing part: PBT					
Approval	CE					
Unit weight*2	Approx. 42g(Approx. 30g)		PRCM: Approx. 66g(Approx. 54g) PRCML: Approx. 78g(Approx. 66g)	PRCM: Approx. 154g(Approx. 142g) PRCML: Approx. 194g(Approx. 182g)		

※1: The response frequency is the average value. The standard sensing target is used and the width is set as 2 times of the standard sensing target, 1/2 of the sensing distance for the distance.
※2: The weight with packaging and the weight in parentheses is only unit weight.
※Environment resistance is rated at no freezing or condensation.

■ Dimensions

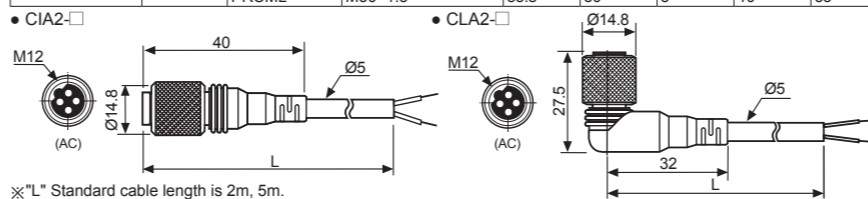
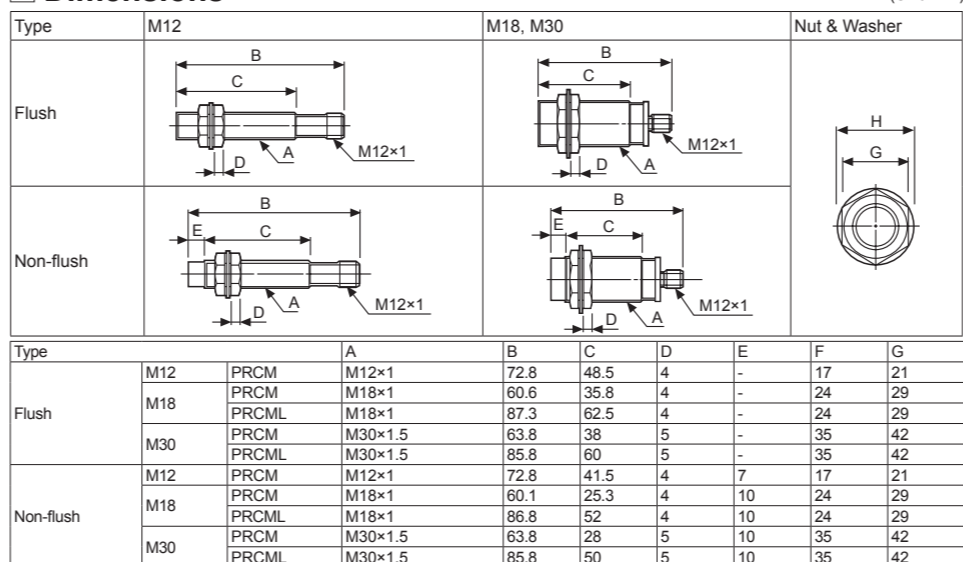

■ Wiring Diagram

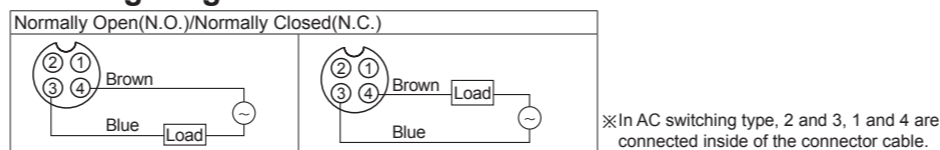

■ Connection of the Power Supply

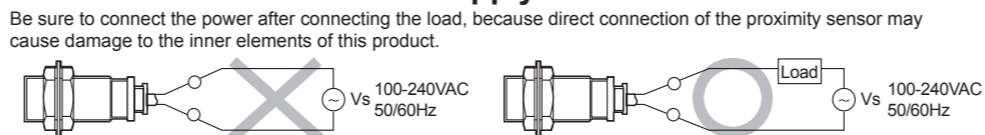

■ Mutual-interference & Influence by Surrounding Metals

○ **Mutual-interference**
When several proximity sensors are mounted closely, malfunction of sensor may be caused due to mutual interference. Therefore, be sure to provide a minimum distance between the two sensors, as below charts.

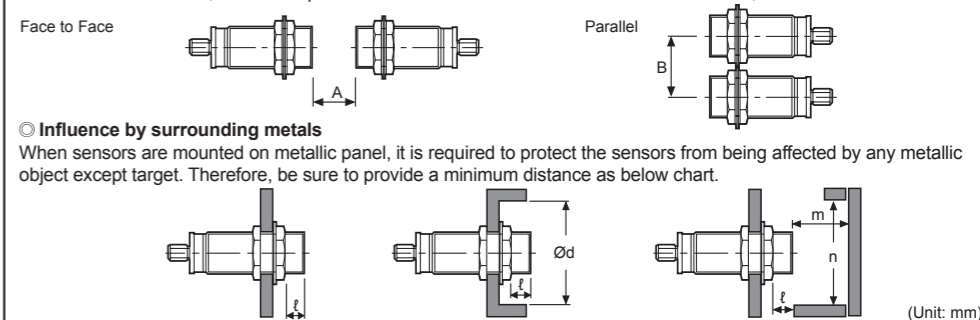

Model	PRCM12-2A □	PRCM12-4A □	PRCM(L)18-5A □	PRCM(L)18-8A □	PRCM(L)30-10A □	PRCM(L)30-15A □
Item						
A	12	24	30	48	60	90
B	24	36	36	54	60	90
ℓ	0	11	0	14	0	15
Ød	12	36	18	54	30	90
m	6	12	15	24	30	45
n	18	36	27	54	45	90

■ Setting Distance

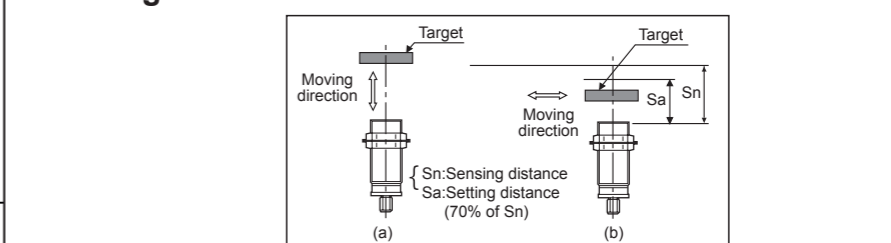

- Sensing distance can be changed by the shape, size or material of the target. Therefore please check the sensing distance like (a), then pass the target within range of setting distance(Sa).
- Setting distance(Sa)=Sensing distance(Sn)×70%
E.g.)PRCM30-10AO
Setting distance(Sa)=10mm×0.7=7mm

■ Installation and Tightening Torque

When tightening the nut, use the provided washer as [Figure 1] according to the distance from the fore-end to the dimension on the below table, and the rear part is from the tip of the nut to the end of the product. [Figure 2]
In case the nut is placed in the front part of the product, apply tightening torque for front part. [Table 1] the allowable tightening torque table is for inserting the washer as [Figure 3].

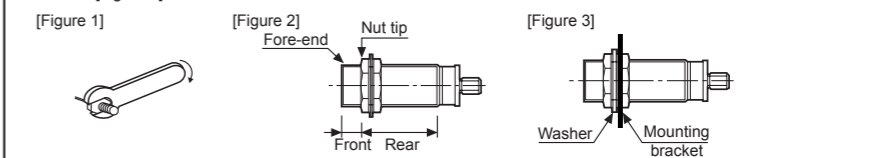

■ Caution during Use

- Follow instructions in 'Cautions during Use'. Otherwise, it may cause unexpected accidents.
- Wire as short as possible and keep away from high voltage lines or power lines, to prevent surge and inductive noise. Do not use near the equipment which generates strong magnetic force or high frequency noise (transceiver, etc.). In case installing the product near the equipment which generates strong surge (motor, welding machine, etc.), use diode or varistor to remove surge.
- Do not connect capacity load to the output terminal directly.
- This unit may be used in the following environments.
 - ① Indoors (in the environment condition rated in 'Specifications')
 - ② Altitude max. 2,000m
 - ③ Pollution degree 2
 - ④ Installation category II

■ Major Products

- Photoelectric sensors
- Fiber optic sensors
- Door sensors
- Door side sensors
- Area sensors
- Proximity sensors
- Pressure sensors
- Rotary encoders
- Connector/Sockets
- Switching mode power supplies
- Control switches/Lamps/Buzzers
- I/O Terminal Blocks & Cables
- Stepper motors/drivers/motion controllers
- Graphic/Logic panels
- Field network devices
- Laser marking system(Fiber, CO₂, Nd:YAG)
- Laser welding/soldering system
- Temperature controllers
- Temperature/Humidity transducers
- SSR/Power controllers
- Counters
- Timers
- Panel meters
- Tachometer/Pulse(Rate) meters
- Display units
- Sensor controllers

Autonics Corporation
http://www.autonics.com

■ HEADQUARTERS:
18, Bansong-ro 513beon-gil, Haeundae-gu, Busan, South Korea, 48002
TEL: 82-51-519-3232
■ E-mail: sales@autonics.com