



**XDG2000 Series Dual-Channel  
Arbitrary Waveform Generator  
User Manual**

**May 2020 Edition V1.0.0**

Copyright © LILLIPUT Company. All rights reserved.

The LILLIPUT's products are under the protection of the patent rights, including ones which have already obtained the patent rights and those which are applied for. The information in this manual will replace all materials published.

The information in this manual was correct at the time of printing. However, LILLIPUT will continue to improve products and reserves the rights to change specification at any time without notice.

**owon**<sup>®</sup> is the registered trademark of the LILLIPUT Company.

# General Warranty

OWON warrants that the product will be free from defects in materials and workmanship for a period of 3 years from the date of purchase of the product by the original purchaser from the OWON Company. The warranty period for accessories such as probes is 12 months. This warranty only applies to the original purchaser and is not transferable to a third party.

If the product proves defective during the warranty period, OWON will either repair the defective product without charge for parts and labour, or will provide a replacement in exchange for the defective product. Parts, modules and replacement products used by OWON for warranty work may be new or reconditioned like new. All replaced parts, modules and products become the property of OWON.

In order to obtain service under this warranty, the customer must notify OWON of the defect before the expiration of the warranty period. Customer shall be responsible for packaging and shipping the defective product to OWON's designated service centre, a copy of the customer's proof of purchase is also required.

This warranty shall not apply to any defect, failure or damage caused by improper use or improper or inadequate maintenance and care. OWON shall not be obligated to furnish service under this warranty a) to repair damage resulting from attempts by personnel other than OWON representatives to install, repair or service the product; b) to repair damage resulting from improper use or connection to incompatible equipment; c) to repair any damage or malfunction caused by the use of non-OWON supplies; or d) to service a product that has been modified or integrated with other products when the effect of such modification or integration increases the time or difficulty of servicing the product.

Please contact the nearest OWON's Sales and Service Offices for services.

**Excepting the after-sales services provided in this summary or the applicable warranty statements, OWON will not offer any guarantee for maintenance definitely declared or hinted, including but not limited to the implied guarantee for marketability and special-purpose acceptability. OWON should not take any responsibilities for any indirect, special or consequent damages.**

# Table of Contents

1.General Safety Requirement .....	1
2.Safety Terms and Symbols.....	2
3.General Inspection.....	3
4.Quick Start .....	4
Front Panel Overview .....	4
Rear Panel Overview .....	6
Foot Stool Adjustment .....	7
Power On.....	7
User Interface .....	8
5.Panel Operation .....	9
Channel Setting .....	9
Select the channel for configuration .....	9
Turn on/off channel output.....	9
Inter-channel .....	9
Waveform Setting.....	9
Output Sine Wave .....	10
Set the frequency/period .....	10
Set the amplitude.....	11
Set the offset .....	11
Set the high level.....	11
Set the low level .....	12
Set the start phase .....	12
Output Square Wave .....	12
Output Ramp Wave .....	13
Set the symmetry .....	13
Output Pulse Wave.....	14
Set the pulse width/duty cycle.....	15
Set the rising/falling time .....	17
Output Noise Wave .....	17
Output Arbitrary Wave.....	17
Select build-in wave (including DC).....	18
Output Harmonic Wave.....	23
Harmonic wave function overview .....	23
Set the Fundamental Wave Parameters.....	24
Select the harmonic type .....	24
Set the harmonic order .....	24
Set the harmonic amplitude of each order .....	25

Set the harmonic phase of each order .....	25
Output the Modulated Waves.....	25
AM (Amplitude Modulation).....	26
DSB-AM (Double-Sideband AM) .....	27
FM (Frequency Modulation) .....	28
PM (Phase Modulation) .....	30
PWM (Pulse Width Modulation).....	31
ASK (Amplitude Shift Keying) .....	32
FSK (Frequency Shift Keying).....	34
PSK (Phase Shift Keying).....	35
3FSK (3 Frequency Shift Keying) .....	36
4FSK (4 Frequency Shift Keying) .....	38
BPSK (Binary Phase Shift Keying).....	39
QPSK (Quadrature Phase Shift Keying).....	40
OSK (Oscillation Shift Keying).....	41
SUM (Sum Modulation).....	42
Generate Sweep (Sweep).....	44
Generate Burst (Burst) .....	45
Set N-Cycle Burst.....	46
Set Gated Burst .....	47
Counter .....	49
Utility Function Setting .....	49
Display Settings .....	50
Brightness Control.....	50
Screen Saver .....	50
Separator .....	50
Date .....	50
Contrast.....	51
CH1/2 Settings.....	51
Sync .....	51
Load.....	52
I/O Setup .....	52
USB Device Type.....	52
Network Setting .....	53
System Settings .....	53
Language .....	53
Beeper .....	53
Clock Source .....	54
Clock Output.....	54
Firmware Update .....	54
Edit the Arbitrary Wave (Edit).....	55
File Store System (Store).....	56
Save the current arbitrary wave.....	56
Bring up arbitrary wave files in internal/external memory.....	57

Erase waveforms from memory .....	57
Save/recall Instrument Settings .....	58
Preset Settings (Preset) .....	58
Restore to the factory setting .....	58
Restore to the user setting .....	62
Power-on setting .....	63
Use Build-in Help (Help) .....	63
<b>6.Communicate with PC.....</b>	<b>64</b>
Using USB Port.....	64
Using LAN Port .....	64
Connect Directly.....	64
Connect through a Router.....	65
<b>7.Troubleshooting .....</b>	<b>67</b>
<b>8.Specification .....</b>	<b>68</b>
Waveforms .....	68
Frequency Characteristics .....	68
Amplitude Characteristics .....	69
Signal Characteristics.....	69
Modulation Characteristics .....	71
Sweep Characteristics .....	73
Burst Characteristics.....	74
Counter Specifications .....	74
Input/Output Characteristics .....	74
General Specifications.....	75
<b>9.Appendix.....</b>	<b>76</b>
Appendix A: Accessories.....	76
Appendix B: General Care and Cleaning.....	76

# 1. General Safety Requirement

**Before any operations, please read the following safety precautions to avoid any possible bodily injury and prevent this product or any other products connected from damage. In order to avoid any contingent danger, this product is only used within the range specified.**

**Only the qualified technicians can implement the maintenance.**

**To avoid Fire or Personal Injury:**

**Use Proper Power Cord.** Use only the power cord supplied with the product and certified to use in your country.

**Product Grounded.** This instrument is grounded through the power cord grounding conductor. To avoid electric shock, the grounding conductor must be grounded. The product must be grounded properly before any connection with its input or output terminal.

**Limit operation to the specified measurement category, voltage, or amperage ratings.**

**Check all Terminal Ratings.** To avoid fire or shock hazard, check all ratings and markers on the instrument. Refer to the user's manual for more information about ratings before connecting the instrument. Do not exceed any of ratings defined in the following section.

**Do not operate without covers.** Do not operate the instrument with covers or panels removed.

**Use Proper Fuse.** Use only the specified type and rating fuse for this instrument.

**Avoid exposed circuit.** Do not touch exposed junctions and components when the instrument is powered.

**Do not operate if in any doubt.** If you suspect damage occurs to the instrument, have it inspected by qualified service personnel before further operations.

**Use your instrument in a well-ventilated area.** Inadequate ventilation may cause an increasing of temperature or damages to the instrument. Please keep the instrument well ventilated, and inspect the air outlet and the fan regularly.

**Do not operate in wet conditions.** To avoid short circuit inside the instrument or electric shock, never operate the instrument in a humid environment.

**Do not operate in an explosive atmosphere.**

**Keep instrument surfaces clean and dry.**

## 2. Safety Terms and Symbols

### Safety Terms

**Terms in this Manual.** The following terms may appear in this manual:



**Warning:** Warning indicates the conditions or practices that could result in injury or loss of life.



**Caution:** Caution indicates the conditions or practices that could result in damage to this product or other property.

**Terms on the Product.** The following terms may appear on this product:

**Danger:** It indicates an injury or hazard may immediately happen.

**Warning:** It indicates an injury or hazard may be accessible potentially.

**Caution:** It indicates a potential damage to the instrument or other property might occur.

### Safety Symbols

**Symbols on the Product.** The following symbol may appear on the product:



Hazardous Voltage



Refer to Manual



Protective Earth Terminal



Chassis Ground



Test Ground



## 3. General Inspection

After you get a new generator, it is recommended that you should make a check on the instrument according to the following steps:

### 1. Check whether there is any damage caused by transportation.

If it is found that the packaging carton or the foamed plastic protection cushion has suffered serious damage, do not throw it away first till the complete device and its accessories succeed in the electrical and mechanical property tests.

### 2. Check the Accessories

The supplied accessories have been already described in *Appendix A: Accessories* of this manual. You can check whether there is any loss of accessories with reference to this description. If it is found that there is any accessory lost or damaged, please get in touch with the distributor of OWON responsible for this service or the OWON's local offices.

### 3. Check the Complete Instrument

If it is found that there is damage to the appearance of the instrument, or the instrument can not work normally, or fails in the performance test, please get in touch with the OWON's distributor responsible for this business or the OWON's local offices. If there is damage to the instrument caused by the transportation, please keep the package. With the transportation department or the OWON's distributor responsible for this business informed about it, a repairing or replacement of the instrument will be arranged by the OWON.

## 4. Quick Start

### Front Panel Overview

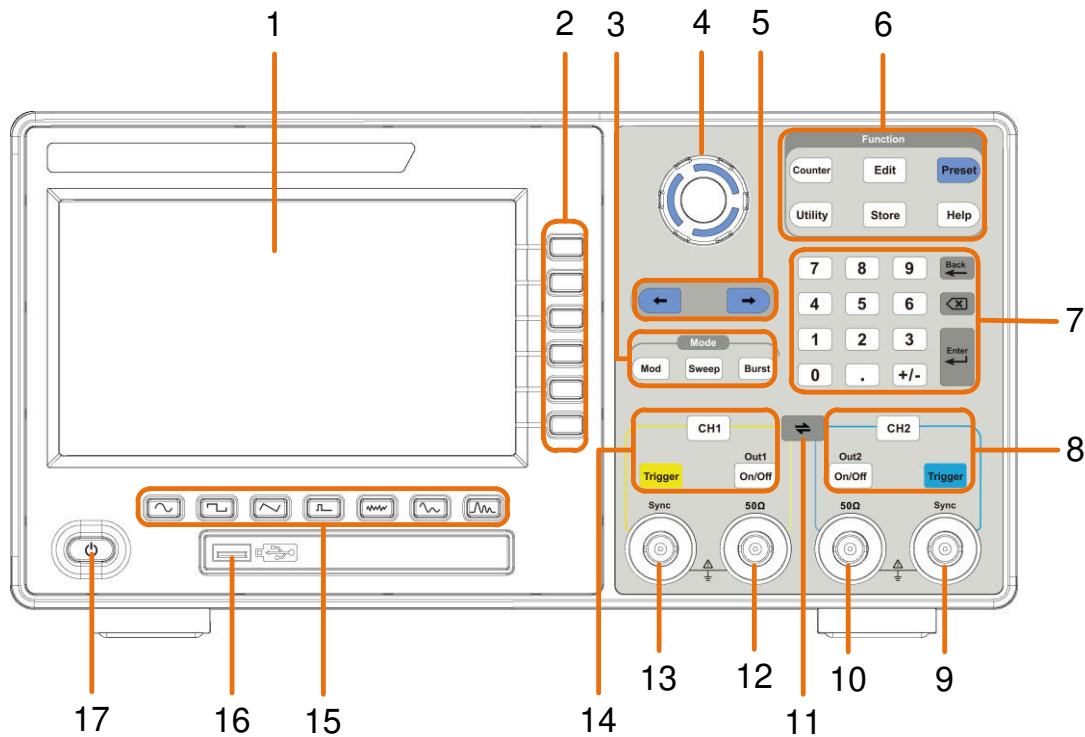







**Figure 4-1: Front Panel overview**

1	<b>LCD</b>	Display the user interface
2	<b>Menu selection keys</b>	Includes 6 keys to activate the corresponding menu
3	<b>Mode keys</b>	<p><b>Mod:</b> Output the modulated waveform</p> <p><b>Sweep:</b> Scan the sine, square, ramp or arbitrary waveforms</p> <p><b>Burst:</b> Generate the sine, square, ramp, pulse or arbitrary burst</p>
4	<b>Knob</b>	<p>Change the currently selected value, also used to select the character in the soft keyboard when the file location or file name is entered.</p> <p>When inserting a USB flash drive, press the knob to save the current display screen to the folder of the USB flash drive in BMP image format.</p>
5	<b>Direction key</b>	Move the cursor of the selected parameter
6	<b>Operation keys</b>	<p><b>Counter:</b> Enter the counter interface</p> <p><b>Edit:</b> Enter the wavform edit interface</p> <p><b>Preset:</b> Enter the preset menu, set the reset parameter or power-on parameter.</p>

## 4.Quick Start

---

	<b>Utility:</b> Set the utility function
	<b>Store:</b> Save/load arbitrary waveform or instrument setup
	<b>Help:</b> To get contextual help for any front panel button or menu softkey, press the button and then press the button for which you need help.
7	<b>Number keypad</b> Input the parameter
8	<b>CH2 Function keys</b> <b>CH2 button:</b> After entering the waveform interface and selecting the CH2 (the backlight of the button is on), the waveform and parameters of CH2 can be set after selection. <b>Blue Trigger button:</b> CH2 manual trigger button. In sweep or burst mode, when the trigger source is selected as “Manual”, each press of this button will initiate a trigger. <b>On/Off button:</b> Turns the output of the CH2 channel on or off. When the output is turned on, the backlight of the button lights up.
9	<b>CH2 Sync</b> When <b>Utility</b> → CH1/2 Set → CH2 Sync turned on, this terminal outputs a synchronization message that matches the current configuration of CH2.
10	<b>CH2 Out</b> Output CH2 signal
11	<b>⇌ button</b> Display the inter-channel menu. You can copy the parameters of one channel to the other, synchronize the frequency or amplitude, and align the phase of two channel signals.
12	<b>CH1 Out</b> Output CH1 signal
13	<b>CH1 Sync</b> When <b>Utility</b> → CH1/2 Set → CH1 Sync turned on, this terminal outputs a synchronization message that matches the current configuration of CH1.
14	<b>CH1 Function keys</b> <b>CH1 button:</b> After entering the waveform interface and selecting the CH1 (the backlight of the button is on), the waveform and parameters of CH1 can be set after selection. <b>Yellow Trigger button:</b> CH1 manual trigger button. In sweep or burst mode, when the trigger source is selected as “Manual”, each press of this button will initiate a trigger. <b>On/Off button:</b> Turns the output of the CH1 channel on or off. When the output is turned on, the backlight of the button lights up.
15	<b>Waveform Selection area</b> Includes: Sine  , Square  , Ramp  , Pulse  , Noise  , Arb Wave  , Harmonic Wave  . When a waveform is selected, the corresponding backlight is lit.

---

- 
- 16 **USB interface**      Connect with external USB devices, e.g. U disk.
- 
- 17 **Power button**      Turn on/off the waveform generator.
- 

## Rear Panel Overview

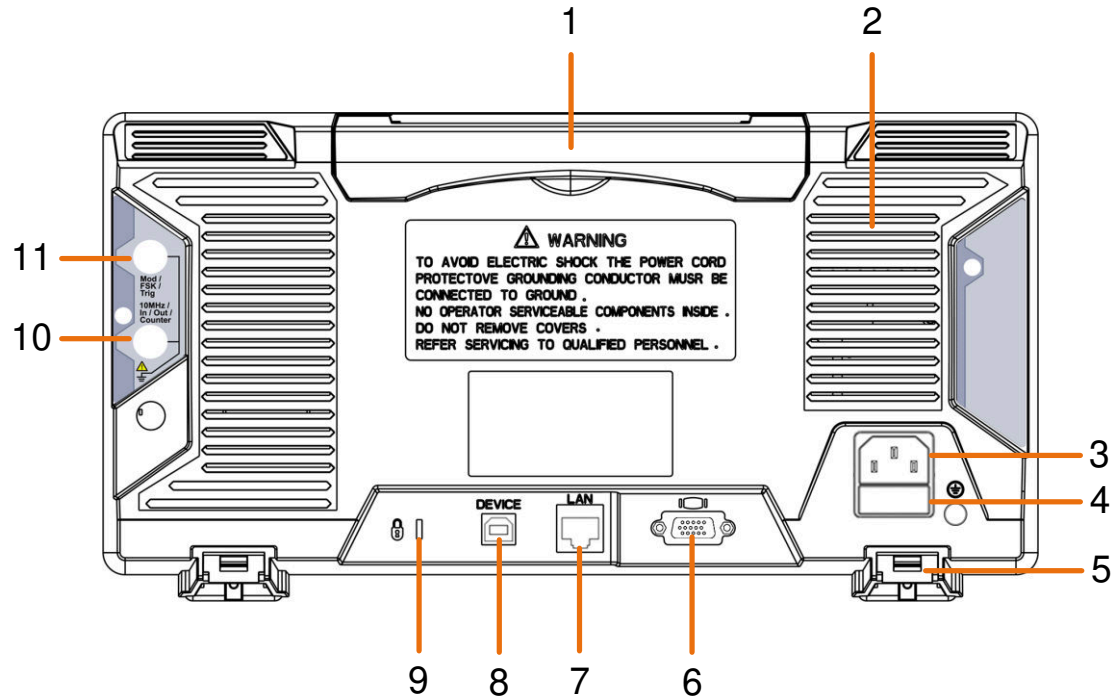

Figure 4-2: Rear Panel Overview

1	<b>Retractable handle</b>	
2	<b>Air vents</b>	
3	<b>AC input connector</b>	AC input connector
4	<b>Fuse Container</b>	The place to install the fuse
5	<b>Foot Stool</b>	Tilt the signal generator for easy operation.
6	<b>COM interface (optional)</b>	This interface can be used to connect with PC.
7	<b>LAN interface</b>	The network port which can be used to connect with PC.
8	<b>USB Device interface</b>	Used to connect a USB type B controller. Can be connected with PC, the signal generator can be controlled by the host computer software.

9	<b>Lock Hole</b>	You can lock the device to a fixed location using the security lock (please buy it yourself) to secure the device.
10	<b>10MHz/In/Out/Counter (refer to clock input/output/counter input) connector</b>	It is default to receive the frequency meter input signal. Used to output a 10MHz clock signal when the instrument is set to an internal clock source and <b>Utility</b> → <b>System</b> → <b>CLK Output</b> is turned on; it is used to receive an external 10MHz clock signal when the instrument is set to an external clock source.
11	<b>Mod/FSK/Trig (modulation/trigger input) connector</b>	<p>When modulating the waveform, outputting the sweep frequency, and outputting the burst, the signal accessed here can be used as an external source.</p> <p><b>Note:</b> If one channel turns on AM, FM, PM, PWM or OSK, and the other channel turns on ASK, FSK, PSK, sweep or burst, and both channels are set to external trigger, then the channel that sets the trigger source can be accessed to external trigger, the other channel automatically cancels the external trigger because of the different external modulation signal types.</p>

---

## Foot Stool Adjustment

Unfold the foot stools on the bottom of the generator, as **5 Foot Stool** in *Figure 4-2*.

## Power On

- (1) Connect the instrument to an AC power source using the power cord supplied with the accessory.



**Warning:**

To prevent electric shock, make sure the instrument is properly grounded.

---

- (2) Press the **power button** on the front panel. The startup screen will display.

## User Interface

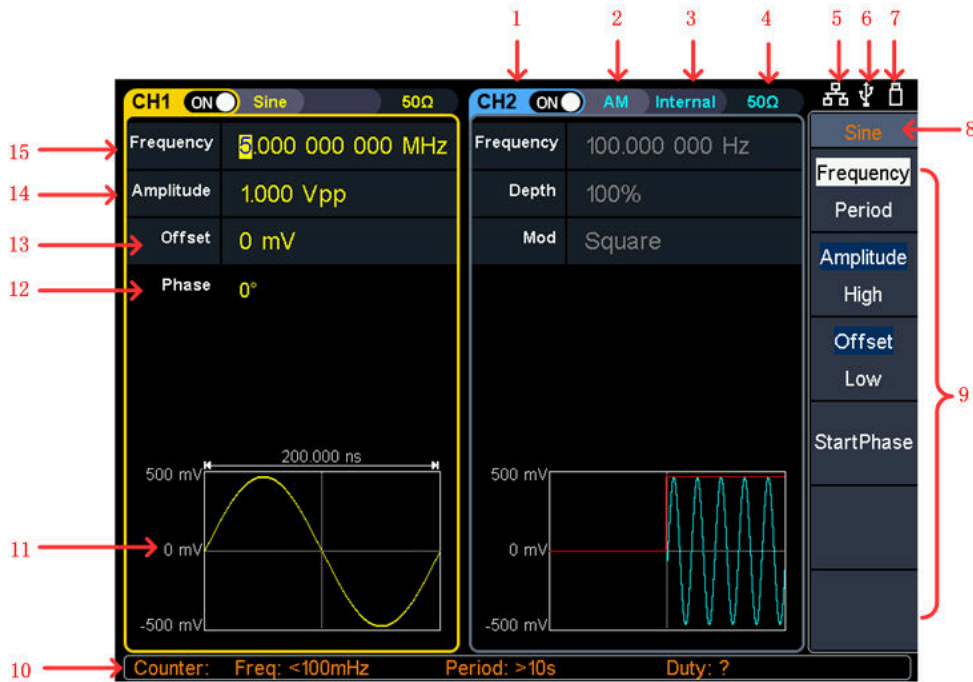

**Figure 4-3: User Interface**

- |    |   |
|----|---|
| 1  | Display channel name and channel switch status  |
| 2  | Current waveform or current mode  |
| 3  | Trigger source<br>Internal: Internal modulation or internal trigger source<br>External: External modulation or external trigger source<br>Manual: Manual trigger source |
| 4  | Load, High Z indicates high resistance  |
| 5  | This indicator is lit when the network is connected through the LAN interface.  |
| 6  | Lights up the indicator when connected to the USB Host via the USB DEVICE interface.  |
| 7  | When the instrument detects the USB flash drive, it lights up the indicator.  |
| 8  | Current menu name   |
| 9  | Current waveform or mode setting menu   |
| 10 | Counter brief information showing frequency value, period value and   |
| 11 | Display current waveform  |
| 12 | Start phase   |
| 13 | Offset / low level, depending on the right highlighted menu item  |
| 14 | Amplitude / high level, depending on the right highlighted menu item  |
| 15 | Frequency/cycle, depending on the highlighted menu item on the right  |

## 5. Panel Operation

### Channel Setting

#### Select the channel for configuration

Before configuring waveform parameters, you must select the channel you want to configure. Press **CH1** or **CH2** to select the corresponding channel, and the corresponding channel area in the user interface will light up.

#### Turn on/off channel output

Press CH1 **On/Off** or CH2 **On/Off** button on the front panel to turn on/off output of the corresponding channel. The backlight of the button will be lighted when the corresponding channel is tuned on.







### Inter-channel

The instrument can copy the parameters of one channel to the other. If frequency or amplitude of both channels are synchronized, when you change the parameter of either channel, the parameter of the other channel is set to the same value.

- (1) Press  on the front panel to display the inter-channel menu.
- (2) Press **CH2 To\_CH1** to copy parameters of CH2 to CH1.
- (3) Press **CH1 To\_CH2** to copy parameters of CH1 to CH2.
- (4) Press **FreqSync** to toggle between **On** and **Off**. At on status, the frequency of the two channels can be adjusted synchronously.
- (5) Press **AmpSync** to toggle between **On** and **Off**. At on status, the amplitude of the two channels can be adjusted synchronously.
- (6) Press **AlignPhase** to align the phase of two channel signals.

### Waveform Setting

Sine, square, ramp, pulse, noise, arbitrary or harmonic waves can be set and output.

Press the waveform selection button on the front panel: sine , square , ramp , pulse , noise , arbitrary wave , harmonic , and

enter the corresponding waveform setting interface. The waveform is different and the parameters that can be set are different.

**Note:** The following setting waveform uses CH1 channel as an example. If you need to set CH2 channel, please refer to CH1 channel specific operation.

## Output Sine Wave

Press , the screen displays the user interface of the sine wave. The Sine waveform parameters can be set by operating the Sine setting menu on the right.

The sine wave menu includes: **Frequency/Period**, **Amplitude/High Level**, **Offset/Low Level**, and **Start Phase**. The menu can be operated by the menu selection button on the right.

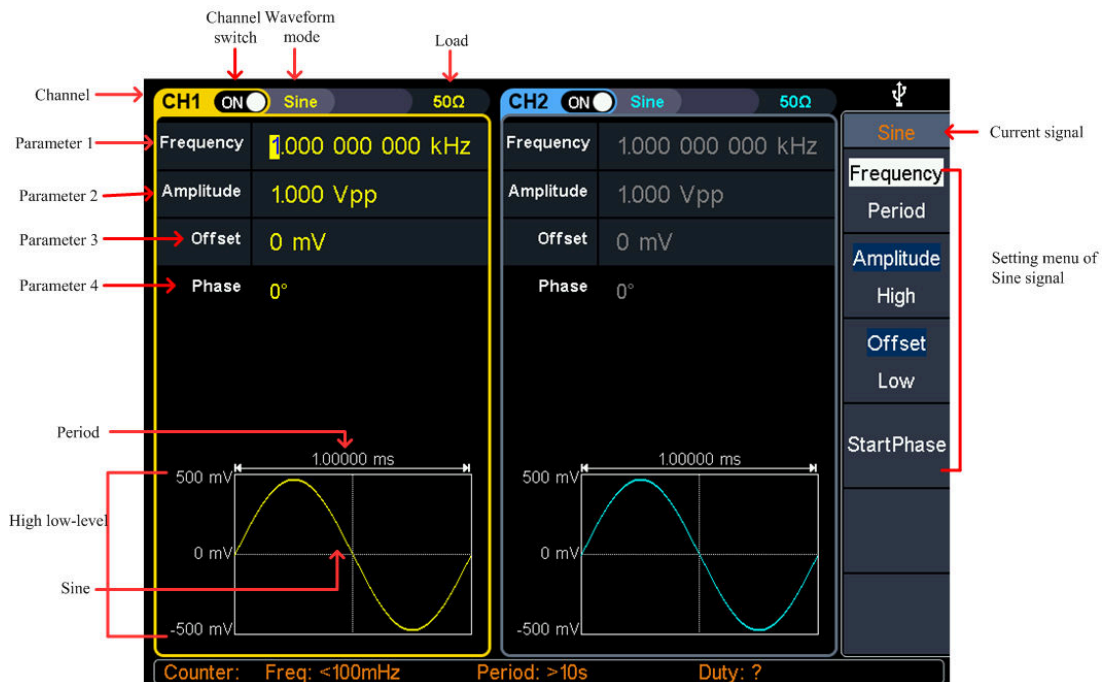



Figure 5-1: Sine wave user interface

### Set the frequency/period

- Press **CH1**, all currently selected CH1 menu items are highlighted.
- Press the **Frequency/Period** softkey, the selected menu item is highlighted in white, and a cursor will display on the corresponding parameter item in **Parameter 1**. Press the **Frequency/Period** softkey to switch the frequency and period.

**There are two ways to change the selected parameter value:**

- Turn the **knob** to increase or decrease the value at the cursor. Press the / arrow key to move the cursor left or right.



- Press a number key on the **numeric keypad** directly, the screen will pop out the data input box, input the desired value. Press the **X** key on the **numeric keypad** to delete the last digit, press the **←** **Back** key to cancel the input, and press the **Enter** key to confirm the input in default unit. Press the **MHz**, **kHz**, **Hz**, **mHz**, **uHz** softkeys to select the unit of the parameter. Press the **Cancel** softkey to cancel the current input parameter value.

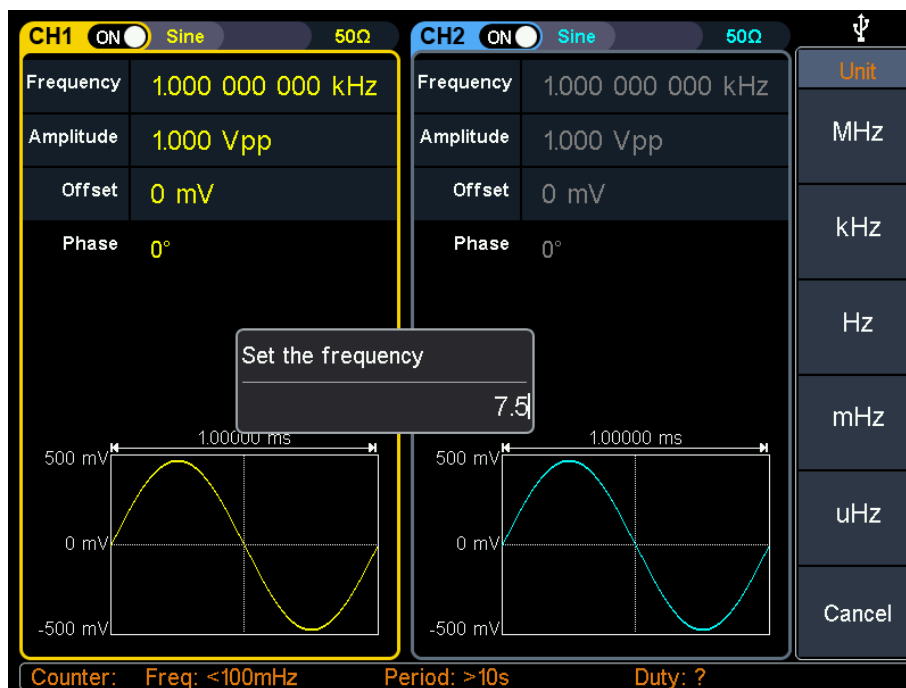

Figure 5-2: Use the numeric keypad to set the frequency

### Set the amplitude

Press the **Amplitude/High** softkey to confirm whether the **Amplitude** menu item is highlighted; if not, press the **Amplitude/High** softkey to switch to **Amplitude**. In **Parameter 2** of Figure 5-1, a blinking cursor appears in the parameter value of amplitude. Turn the **knob** to change the value directly, or use the **numeric keypad** to input the desired value and choose the unit.

### Set the offset

Press the **Offset/Low** softkey to confirm whether the **Offset** menu item is highlighted; if not, press the **Offset/Low** softkey to switch to **Offset**. In **Parameter 3** of Figure 5-1, a blinking cursor appears in the parameter value of offset. Turn the **knob** to change the value directly, or use the **numeric keypad** to input the desired value and choose the unit.

### Set the high level

Press the **Amplitude/High** softkey to confirm whether the **High** menu item is highlighted; if not, press the **Amplitude/High** softkey to switch to **High**. In **Parameter**

2 of Figure 5-1, a blinking cursor appears in the parameter value of high level. Turn the **knob** to change the value directly, or use the **numeric keypad** to input the desired value and choose the unit.

### Set the low level

Press the **Offset/Low** softkey to confirm whether the **Low** menu item is highlighted; if not, press the **Offset/Low** softkey to switch to **Low**. In **Parameter 3** of Figure 5-1, a blinking cursor appears in the parameter value of low level. Turn the **knob** to change the value directly, or use the **numeric keypad** to input the desired value and choose the unit.

### Set the start phase

Press the **Start Phase** softkey, the **Start Phase** menu item is highlighted. In **Parameter 4** of Figure 5-1, a blinking cursor appears in the parameter value of start phase. Turn the **knob** to change the value directly, or use the **numeric keypad** to input the desired value and choose the unit.

### Output Square Wave

Press , the screen displays the user interface of the square wave. The Square waveform parameters can be set by operating the Square setting menu on the right. The square wave menu includes: **Frequency/Period**, **Amplitude/High Level**, **Offset/Low Level**, and **Start Phase**.

To set the Frequency/Period, Amplitude/High Level, Offset/Low Level, Start Phase, please refer to *Output Sine Wave* on page 10.

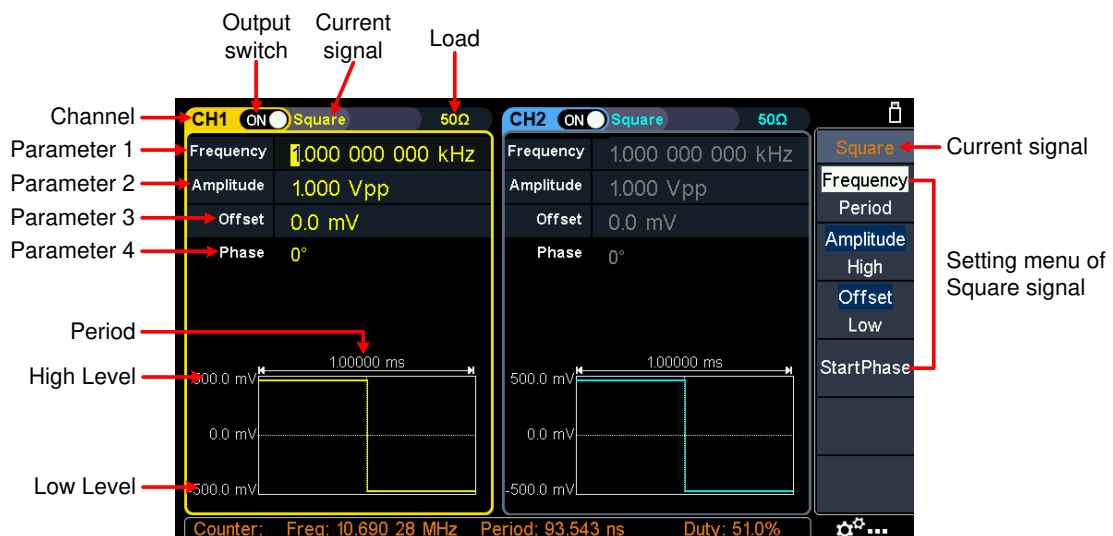



Figure 5-3: Square wave user interface

## Output Ramp Wave

Press , the screen displays the user interface of the ramp wave. The Ramp waveform parameters can be set by operating the Ramp setting menu on the right.

The ramp menu includes: **Frequency/Period**, **Amplitude/High Level**, **Offset/Low Level**, **Start Phase**, and **Symmetry**.

To set the Frequency/Period, Amplitude/High Level, Offset/Low Level, Start Phase, please refer to *Output Sine Wave* on page 10.



Figure 5-4: Ramp wave user interface

### Set the symmetry

Press the **Symmetry** softkey, the **Symmetry** menu item is highlighted. In **Parameter 5** of Figure 5-4, a blinking cursor appears in the parameter value of symmetry. Turn the **knob** to change the value directly, or use the **numeric keypad** to input the desired value and choose the unit.

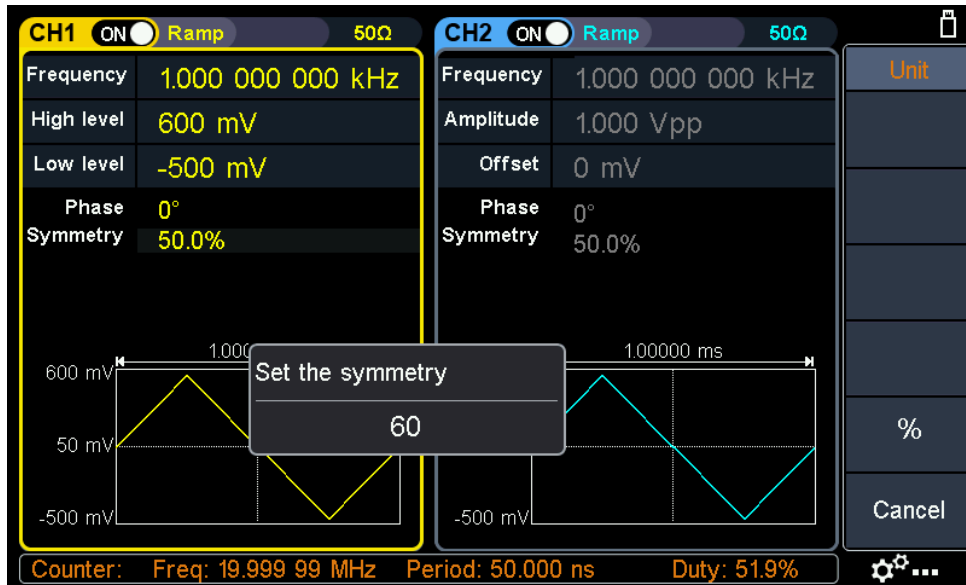



Figure 5-5: Set the symmetry of ramp wave

### Glossary

**Symmetry:** Sets the percentage of the period during which the ramp waveform is rising.

### Output Pulse Wave

Press , the screen displays the user interface of the pulse wave. The Pulse waveform parameters can be set by operating the Pulse setting menu on the right.

The pulse wave menu includes: **Frequency/Period**, **Amplitude/High Level**, **Offset/Low Level**, **Start Phase**, **Pulse Width/Duty Cycle**, and **Rising Time/Falling Time**.

To set the Frequency/Period, Amplitude/High Level, Offset/Low Level, Start Phase, please refer to *Output Sine Wave* on page 10.

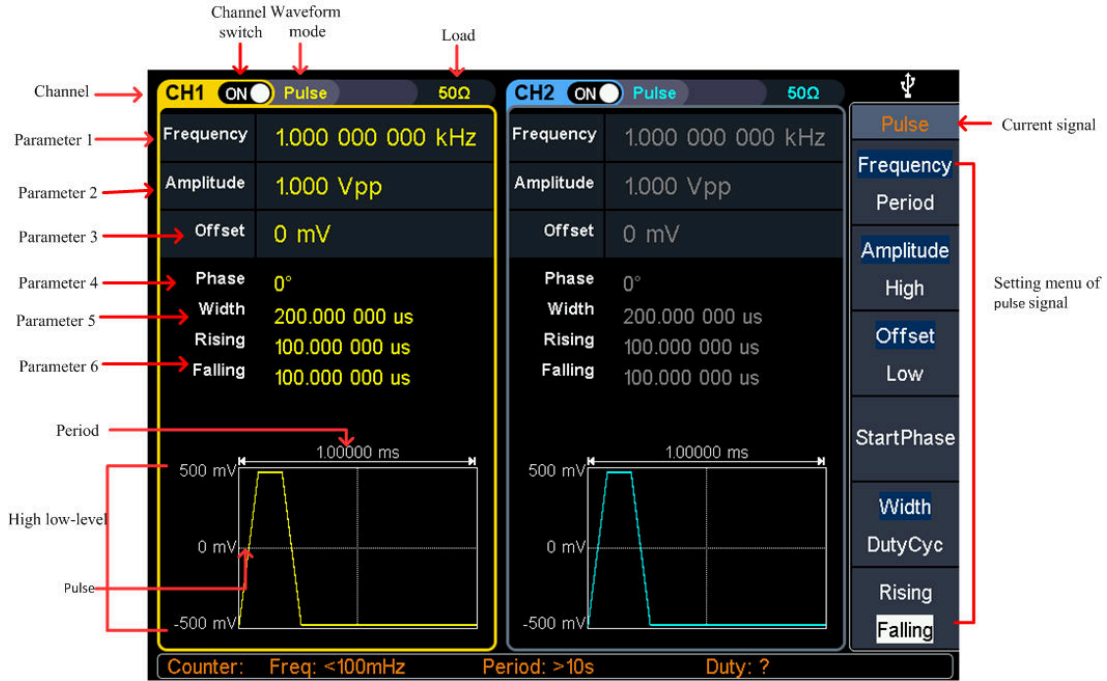

Figure 5-6: Pulse wave user interface

### Set the pulse width/duty cycle

Press the **Width/DutyCyc** softkey, the chosen menu item is highlighted. Press the **Width/DutyCyc** softkey to switch between Pulse Width and Duty Cycle. In **Parameter 5** of Figure 5-6, a blinking cursor appears in the parameter value. Turn the **knob** to change the value directly, or use the **numeric keypad** to input the desired value and choose the unit.

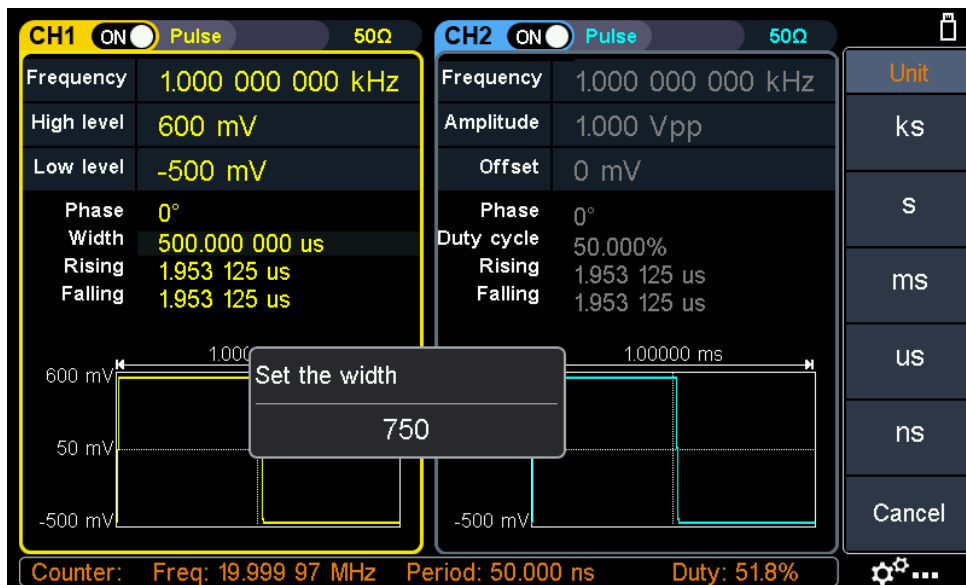

Figure 5-7: Set the pulse width

## Glossary

**Pulse Width**

PW is an abbreviation for pulse width and is divided into positive pulse width and negative pulse width.

The positive pulse width is the time interval from 50% of the rising edge to 50% of the adjacent falling edge.

The negative pulse width is the time interval from 50% of the falling edge to 50% of the adjacent rising edge.

The pulse width is determined by the period and duty cycle of the signal. The calculation formula is pulse width = period \* duty cycle.

**Duty Cycle**

In a series of ideal pulse sequences (such as a square wave), the ratio of the duration of the positive pulse to the total pulse period.

**Pulse/Duty Cycle**

The pulse width is defined as the time interval from the 50% threshold of the amplitude of the rising edge of the pulse to the 50% threshold of the amplitude of the next falling edge, as shown in the following figure.

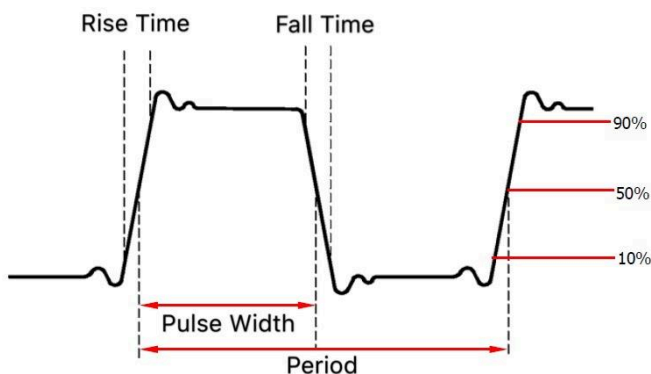

- The settable range of pulse width is limited by the "minimum pulse width" and "pulse period"  
 $\text{Pulse width} \geq \text{minimum pulse width}$   
 $\text{Pulse width} \leq \text{pulse period} - \text{minimum pulse width}$
- The pulse duty cycle is defined as the pulse width as a percentage of the pulse period.
- The pulse duty cycle is associated with the pulse width, and modifying one of the parameters will automatically modify the other parameter. The pulse duty cycle is limited by the "minimum pulse width" and "pulse period".  
 $\text{Pulse duty cycle} \geq \text{minimum pulse width} \div \text{pulse period} \times 100\%$   
 $\text{Pulse duty cycle} \leq (1 - 2 \times \text{minimum pulse width} \div \text{pulse period}) \times 100\%$

## Set the rising/falling time

Press the **Rising/Falling** softkey, the chosen menu item is highlighted. Press the **Rising/Falling** softkey to switch between Rising Time and Falling Time. In **Parameter 6** of Figure 5-6, a blinking cursor appears in the parameter value. Turn the **knob** to change the value directly, or use the **numeric keypad** to input the desired value and choose the unit.

## Output Noise Wave

The noise wave which the generator output is white noise. Press , the screen displays the user interface of the noise wave. The Noise waveform parameters can be set by operating the Noise setting menu on the right.

The noise wave has no frequency and periodic parameters.

The noise wave menu includes: **Amplitude/High Level, Offset/Low Level**.

To set the Amplitude/High Level, Offset/Low Level, please refer to *Output Sine Wave* on page 10.



Figure 5-8: Noise wave user interface

## Output Arbitrary Wave

Press , the screen displays the user interface of the arbitrary wave. The Arbitrary waveform parameters can be set by operating the Arbitrary setting menu on the right.

The arbitrary wave menu includes: **Frequency/Period**, **Amplitude/High Level**, **Offset/Low Level**, **Start Phase**, and **Built-in Waveform**.

To set the Frequency/Period, Amplitude/High Level, Offset/Low Level, Start Phase, please refer to *Output Sine Wave* on page 10.

The Arbitrary signal consists of two types: the system built-in waveform and the user-definable waveform.

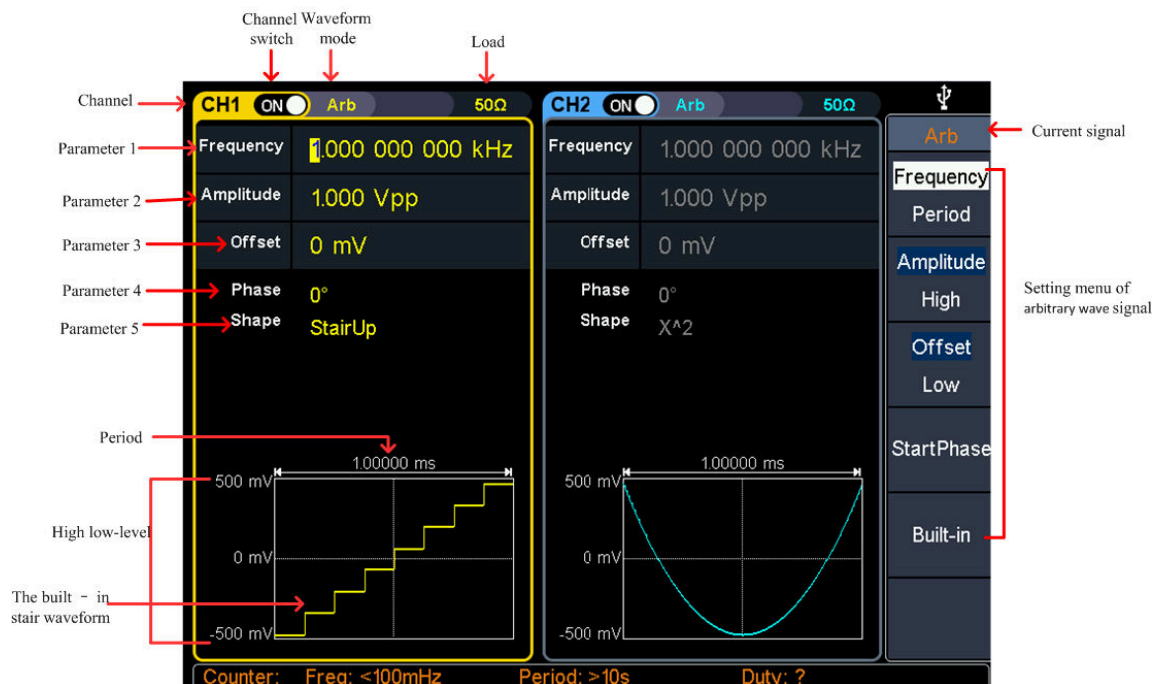



Figure 5-9: Arbitrary wave user interface

### Select built-in wave (including DC)

There are 152 types of waveforms built in the generator, the number of waveform points is 8192 points, and the highest upper limit frequency is 15MHz. To select a built-in waveform, the steps are as follows:

- (1) Press the  **Arb** wave button, then press the **Built-in** softkey to enter the built-in wave menu.
- (2) Press **Common**, **Medical treatment**, **Standard**, **Maths** softkeys to select the built-in wave type.  
Press **NextPage** softkey to enter the next page, select the built-in wave type: **Trigonometric**, **Window function**, **Engineering**, and **Seg Mod** (Segmentation Modulation).  
Press **NextPage** softkey to enter the next page, select the built-in wave type **Fan test**.

For example, select **Common** to enter the interface shown below.



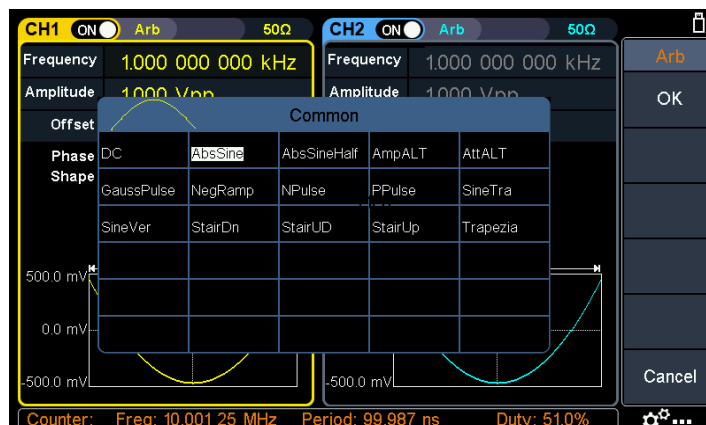

(3) Turn the knob to select the desired waveform, for example, select AbsSine. Press the OK softkey to enter the Airy function.

Note: DC is a type of built-in waveform, located in the Common type, named "DC".

### Built-in wave list

Name	Description
<b>Common</b>	
DC	Direct current
AbsSine	Absolute sine
AbsSineHalf	Absolute half-sine
AmpALT	Gain oscillation curve
AttALT	Attenuation oscillation curve
GaussPulse	Gauss pulse
NegRamp	Negative ramp
NPulse	Negative pluse
PPulse	Positive pluse
SineTra	Sine-Tra wave
SineVer	Sine-Ver wave
StairDn	Stair downward
StairUD	Stair upward/downward
StairUp	Stair upward
Trapezia	Trapezia
<b>Medical treatment</b>	
Heart	Heart
Cardiac	Cardiac
LFPulse	Low frequency pulse electrotherapy waveform
Tens1	Neuroelectric stimulation therapy waveform 1
Tens2	Neuroelectric stimulation therapy waveform 2
Tens3	Neuroelectric stimulation therapy waveform 3
EOG	Electrooculogram
EEG	electroencephalogram
Pulseilogram	Ordinary pulse curve

## 5. Panel Operation

ResSpeed	Ordinary expiratory flow rate curve
<b>Standard</b>	
Ignition	Automobile internal combustion engine ignition waveform
TP2A	Automotive transients due to inductance in the wiring
ISP	Automobile starting profile with oscillation
VR	Working voltage profile of the car when resetting
TP1	Automotive transients due to power cuts
TP2B	Car transients due to startup switching off
TP4	Car working profile during start-up
TP5A	Car transients due to the power cut of battery
TP5B	Car transients due to the power cut of battery
SCR	Sintering temperature release map
Surge	Surge signal
<b>Maths</b>	
Airy	Airy function
Besselj	Type I Bessel function
Bessely	Type II Bessel function
Cauchy	Cauchy distribution
X^3	Cubic function
Erf	Error function
Erfc	Remnant error function
ErfcInv	Anti-complement error function
ErfInv	Inverse error function
Dirichlet	Dirichlet function
ExpFall	Exponential decline function
ExpRise	Exponential rise function
Laguerre	Four Laguerre polynomials
Laplace	Laplace distribution
Legend	Five Legendre polynomials
Gauss	Gaussian distribution, also known as the normal distribution
HaverSine	Semi-positive function
Log	Base 10 logarithmic function
LogNormal	Lognormal distribution
Lorentz	Lorentz function
Maxwell	Maxwell distribution
Rayleigh	Rayleigh distribution
Versiera	Tongue line
Weibull	Weber distribution
Ln(x)	Natural logarithmic waveform
X^2	Square function
Round	Round wave
Chirp	Linear frequency modulation
Rhombus	Diamond wave

## 5. Panel Operation

<b>Trigonometric function</b>	
CosH	Hyperbolic cosine
Cot	Cotangent function
CotH	Hyperbolic cotangent
CotHCon	Concave hyperbolic cotangent
CotHPro	Raised hyperbolic cotangent
CscCon	Recessed cosecant
Csc	Cosecant
CscPro	Raised cosecant
Csch	Hyperbolic cosecant
CschCon	Depressed hyperbolic cosecant
CschPro	Raised hyperbolic cosecant
RecipCon	Reciprocal of the depression
RecipPro	Raised countdown
SecCon	Depression secant
SecPro	Raised secant
SecH	Hyperbolic secant
Sinc	Sinc function
SinH	Hyperbolic sine
Sqrt	Square root function
Tan	Tangent function
TanH	Hyperbolic tangent
ACos	Inverse cosine function
ACosH	Inverse hyperbolic cosine function
ACot	Anti-cotangent function
ACotCon	Inverse cotangent function
ACotPro	Raised inverse cotangent function
ACotH	Inverse hyperbolic cotangent function
ACotHCon	Inverse hyperbolic cotangent function
ACotHPro	Raised inverse hyperbolic cotangent function
Acsc	Anti-cosecting function
ACscCon	Concave inverse cosecting function
ACscPro	Raised anti-cosecting function
AcscH	Anti-hyperbolic cosecant
ACscHCon	Inverse hyperbolic cotangent function
ACscHPro	Raised inverse hyperbolic cosecant function
Asec	Inverse cut function
ASecCon	Inverse tangent function
ASecPro	Raised arctangent function
ASecH	Inverse hyperbolic secant function
ASin	Inverse sine function
ASinH	Inverse hyperbolic sine function
ATan	Arc tangent function

## 5. Panel Operation

ATanH	Inverse hyperbolic tangent function
<b>Window function</b>	
Bartlett	Bartlett window
BarthannWin	Modified Bartlett window
Blackman	Blackman window
BlackmanH	BlackmanH window
BohmanWin	BohmanWin window
Boxcar	Rectangular window
ChebWin	Chebyshev window
FlattopWin	Flat top window
Hamming	Hamming window
Hanning	Hanning window
Kaiser	Kaiser window
NuttallWin	The smallest four Blackman-Harris windows
ParzenWin	Parzen window
TaylorWin	Taylor window
Triang	Triangle window, also call Fejer window
TukeyWin	Tukey window
<b>Engineering Window</b>	
Butterworth	Butterworth filter
Combin	Combined function
CPulse	C-Pulse signal
CWPulse	CW pulse signal
RoundHalf	Half-round wave
BandLimited	Band limited signal
BlaseiWave	Blasting vibration "time-vibration speed" curve
Chebyshev1	Type I Chebyshev filter
Chebyshev2	Type II Chebyshev filter
DampedOsc	Damped oscillation "time-displacement" curve
DualTone	Dual audio signal
Gamma	Gamma signal
GateVibar	Gate self-vibration signal
LFMPulse	Chirp signal
MCNoise	Mechanical construction noise
Discharge	NiMH battery discharge curve
Quake	Seismic wave
Radar	Radar signal
Ripple	Ripple
RoundsPM	RoundsPM wave
StepResp	Step response signal
SwingOsc	Swing oscillation kinetic energy-time curve
TV	TV signal
Voice	Voice signal

Segement Modulation	
AM	Sinusoidal segmented AM wave
FM	Sinusoidal segmented FM wave
PM	Sinusoidal segmented PM wave
PWM	Pulse width segmented PWM wave
Fan test	
64n/1024	Order adjustment (n is an integer, the range is 0 - 16)

## Output Harmonic Wave

Press the  **Harmonic** wave button, the screen displays the user interface of the harmonic wave. The Harmonic waveform parameters can be set by operating the Harmonic setting menu on the right.

The harmonic wave menu includes: **Frequency/Period**, **Amplitude/High Level**, **Offset/Low Level**, **Start Phase**, **Harmonic Type**, **Harmonic Order**, **Sequence Number**, **Harmonic Amplitude**, **Harmonic Phase**.

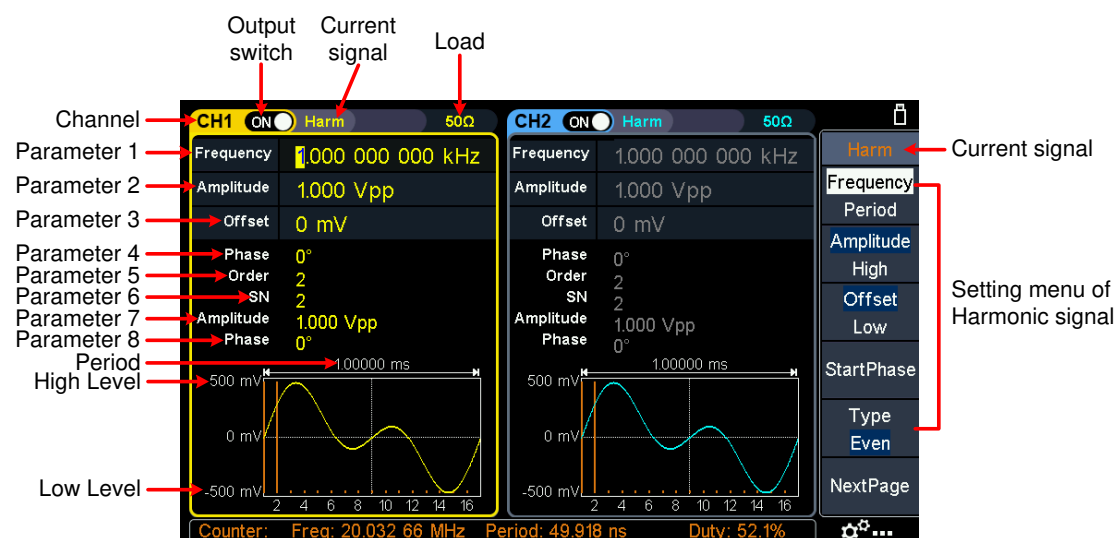

Figure 5-10: Harmonic wave user interface

## Harmonic wave function overview

According to Fourier transform theory, time domain waveform is the superposition of a series of sine waveforms, expressed by the following equation:

$$f(t) = A_1 \sin(2\pi f_1 t + \varphi_1) + A_2 \sin(2\pi f_2 t + \varphi_2) + A_3 \sin(2\pi f_3 t + \varphi_3) + \dots$$

Generally, the component of frequency  $f_1$  is called the fundamental wave,  $f_1$  is the fundamental waveform frequency,  $A_1$  is the fundamental waveform amplitude, and  $\varphi_1$  is the fundamental waveform phase. The frequencies of other component are all integral multiples of the fundamental waveform frequency, which is called harmonic. A component whose frequency is an odd multiple of the fundamental frequency is called an odd harmonic, and a component whose frequency is an even multiple of

the fundamental frequency is called an even harmonic.

This waveform generator can output up to 16th order of harmonic. After selecting CH1 or CH2, press the  **Harmonic** wave button to enter the harmonic setting menu. You can set the parameters of the fundamental waveform, select the type of harmonic, specify the highest order of harmonic, and set the amplitude and phase of each order of harmonic.

### Set the Fundamental Wave Parameters

To set the fundamental waveform parameters such as Frequency/Period, Amplitude/High Level, Offset/Low Level, Start Phase, please refer to *Output Sine Wave* on page 10.

### Select the harmonic type

This generator can output even harmonic, odd harmonic, all orders of harmonic or user-defined orders of harmonic. After entering the harmonic setting menu and press the **Type** softkey to select the desired harmonic type.

- **Even harmonic**  
Press the **Type** softkey and switch to **Even**, the generator would output the fundamental wave and even harmonics.
- **Odd harmonic**  
Press the **Type** softkey and switch to **Odd**, the generator would output the fundamental wave and odd harmonics.
- **Sequential harmonic**  
Press the **Type** softkey and switch to **Sequential**, the generator would output the fundamental wave and each harmonic in sequence.
- **Custom**  
Press the **Type** softkey and switch to **Custom**, you can customize the orders of output harmonics. The highest order is 16.  
The 16-bit binary data is used to represent the output status of the 16 orders of harmonics respectively, 1 represents enabling the output of the corresponding harmonic, and 0 represents disabling the output of the corresponding harmonic. You only need to use the numeric keypad to modify the value of each data bit (Note: the leftmost bit represents the fundamental wave, which is fixed to **X** and cannot be modified). For example, set the 16-bit data to X001 0000 0000 0001, the generator will output the fundamental wave, the 4th order harmonic, and the 16th order harmonic.  
Note: The actual output harmonics are determined by the “**Order**” currently specified.

### Set the harmonic order

After entering the harmonic setting menu, press the **NextPage** softkey to enter the

next page, and press the **Order** softkey, the **Order** menu item is highlighted. In **Parameter 5** of Figure 5-10, a blinking cursor appears in the parameter value of order. Turn the **knob** to change the value directly, or use the **numeric keypad** to input the desired value, which can be set from 2 to 16.

### Set the harmonic amplitude of each order

After entering the harmonic setting menu, press the **NextPage** softkey to enter the next page.

- (1) **Select the sequence number of the harmonic:** Press the **SN** softkey, the **SN** menu item is highlighted. In **Parameter 6** of Figure 5-10, a blinking cursor appears in the parameter value of SN. Turn the **knob** to change the value directly, or use the **numeric keypad** to input the desired value.
- (2) **Set the amplitude of the selected SN:** Press the **Amplitude** softkey, the **Amplitude** menu item is highlighted. In **Parameter 7** of Figure 5-10, a blinking cursor appears in the parameter value of Amplitude. Turn the **knob** to change the value directly, or use the **numeric keypad** to input the desired value and choose the unit.

### Set the harmonic phase of each order

After entering the harmonic setting menu, press the **NextPage** softkey to enter the next page.

- (1) **Select the sequence number of the harmonic:** Press the **SN** softkey, the **SN** menu item is highlighted. In **Parameter 6** of Figure 5-10, a blinking cursor appears in the parameter value of SN. Turn the **knob** to change the value directly, or use the **numeric keypad** to input the desired value.
- (2) **Set the phase for the selected SN:** Press the **Phase** softkey, the **Phase** menu item is highlighted. In **Parameter 8** of Figure 5-10, a blinking cursor appears in the parameter value of Phase. Turn the **knob** to change the value directly, or use the **numeric keypad** to input the desired value and choose the unit.

## Output the Modulated Waves

Supported modulation types include: AM (Amplitude Modulation), FM (Frequency Modulation), PM (Phase Modulation), PWM (Pulse Width Modulation), ASK (Amplitude Shift Keying), PSK (Phase Shift Keying), FSK (Frequency Shift Keying), 3FSK (Ternary Frequency Shift Keying), 4FSK (Quadrature Frequency Shift Keying), BPSK (Biphase Phase Shift Keying), QPSK (Quadrature Phase Shift Keying), OSK (Oscillating Keying), SUM (Sum Modulation), DSB-AM (Double-Sideband Amplitude Modulation).

Press the **Mod** function key, then press the **Type** softkey, turn the **knob** to select the modulation type, press the **OK** softkey to enter the setup menu. To turn off the modulation, press the **Mod** function button again.

**Note:** The following output modulation waveform uses CH1 as an example. If you need to set CH2, please refer to CH1 operation.





## AM (Amplitude Modulation)

The modulated waveform consists of the carrier wave and the modulating wave. For AM, the amplitude of the carrier wave varies with the instantaneous voltage of the modulating wave. The AM user interface is shown below.



Figure 5-11: AM user interface

### How to set the parameters of AM

- (1) Press the **Mod** function key, then press the **Type** softkey, turn the knob to select **AM**, press the **OK** softkey.
- (2) **Select carrier wave shape:**  
The carrier wave can be **Sine**, **Square**, **Ramp**, or **Arbitrary** wave (except DC). Press , , , or  to select a desired carrier wave shape.
- (3) **Set carrier wave parameters:**  
Press the **wave shape key** of the selected carrier wave to display the waveform and parameters of the carrier wave. You can change the parameters of the carrier wave. Press **Mod** to return to the modulation mode interface.
- (4) **Select modulating wave source:**  
Press the **Source** softkey to select the modulating wave source.  
If you select **External**, use the **Mod/FSK/Trig** connector at the rear panel to input the external modulating signal, the AM setting is completed.  
If you select **Internal**, continue with the following steps.



**(5) Select modulating wave shape:**

Press the **Shape** softkey, then press the **Sine**, **Square**, **Ramp**, **Noise**, or **Arb** softkey to select the modulating wave.

**(6) Set modulating wave frequency:**

Press the **AM Frequency** softkey to set the modulating wave frequency. The range is 2 mHz – 1 MHz (for internal source only).

**(7) Set modulation depth:**

Press the **Depth** softkey to set the modulation depth. The range is 0% - 120%.

Glossary

**AM frequency**

The frequency of the modulating waveform.

**Modulation Depth**

The amplitude range of modulating waveform. In 0% modulation, the output amplitude is half of the specified value. In 100% modulation, the output amplitude is equal to the specified value. For an external source, the depth of AM is controlled by the voltage level of the signal connected to the **Mod/FSK/Trig** connector at the rear panel. +1 V corresponds to the currently set depth 100%.

**DSB-AM (Double-Sideband AM)**

The generator supports two kinds of amplitude modulation: normal AM and Double Sideband AM. In normal AM, the modulated waveform contains carrier components. As the carrier components do not carry information, the modulation efficiency is low. To improve the modulation efficiency, you can suppress the carrier components on the basis of the normal AM. At this point, all the modulated waveform components carry information. This mode is called DSB-AM (Double Sideband suppressed carrier modulation). The DSB-AM user interface is shown below.

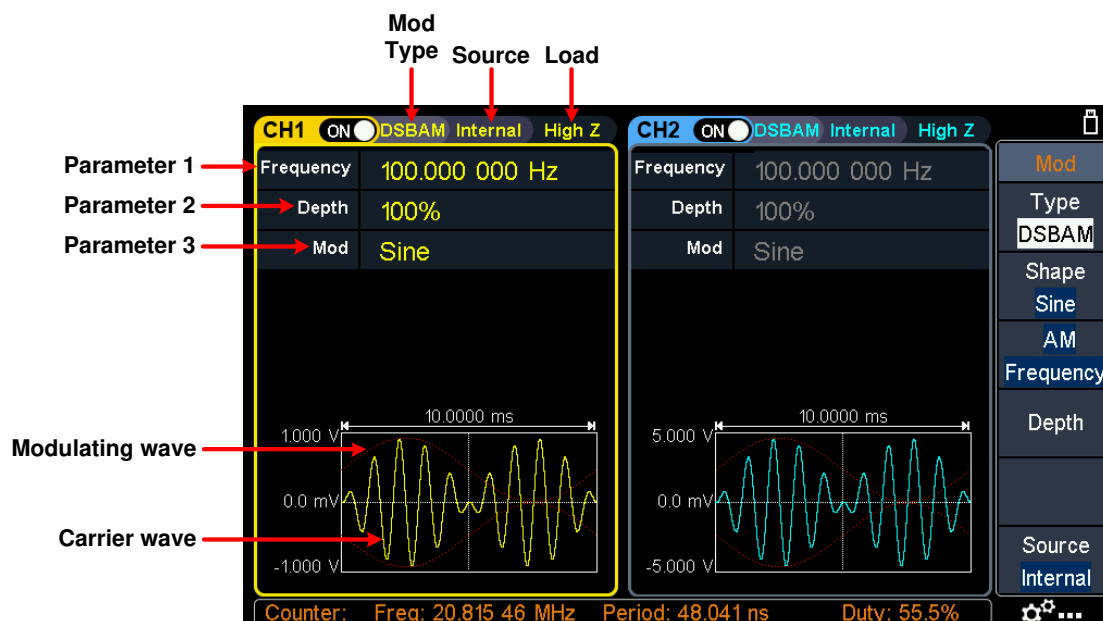





Figure 5-12: DSB-AM user interface

### How to set the parameters of DSB-AM

- (1) Press the **Mod** function key, then press the **Type** softkey, turn the **knob** to select **DSBAM**, press the **OK** softkey.
- (2) **Select carrier wave shape:**  
The carrier wave can be **Sine**, **Square**, or **Ramp**. Press , , or  to select a desired carrier wave shape.
- (3) **Set carrier wave parameters:**  
Press the **wave shape key** of the selected carrier wave to display the waveform and parameters of the carrier wave. You can change the parameters of the carrier wave. Press **Mod** to return to the modulation mode interface.
- (4) **Select modulating wave source:**  
Press the **Source** softkey to select the modulating wave source.  
If you select **External**, use the **Mod/FSK/Trig** connector at the rear panel to input the external modulating signal, the DSB-AM setting is completed.  
If you select **Internal**, continue with the following steps.
- (5) **Select modulating wave shape:**  
Press the **Shape** softkey, then press the **Sine**, **Square**, or **Ramp** softkey to select the modulating wave.
- (6) **Set modulating wave frequency:**  
Press the **AM Frequency** softkey to set the modulating wave frequency. The range is 2 mHz – 1 MHz (for internal source only).
- (7) **Set modulation depth:**  
Press the **Depth** softkey to set the modulation depth. The range is 0% - 100%.

### FM (Frequency Modulation)

The modulated waveform consists of the carrier wave and the modulating wave. For FM, the frequency of the carrier wave varies with the instantaneous voltage of the modulating wave. The FM user interface is shown below.

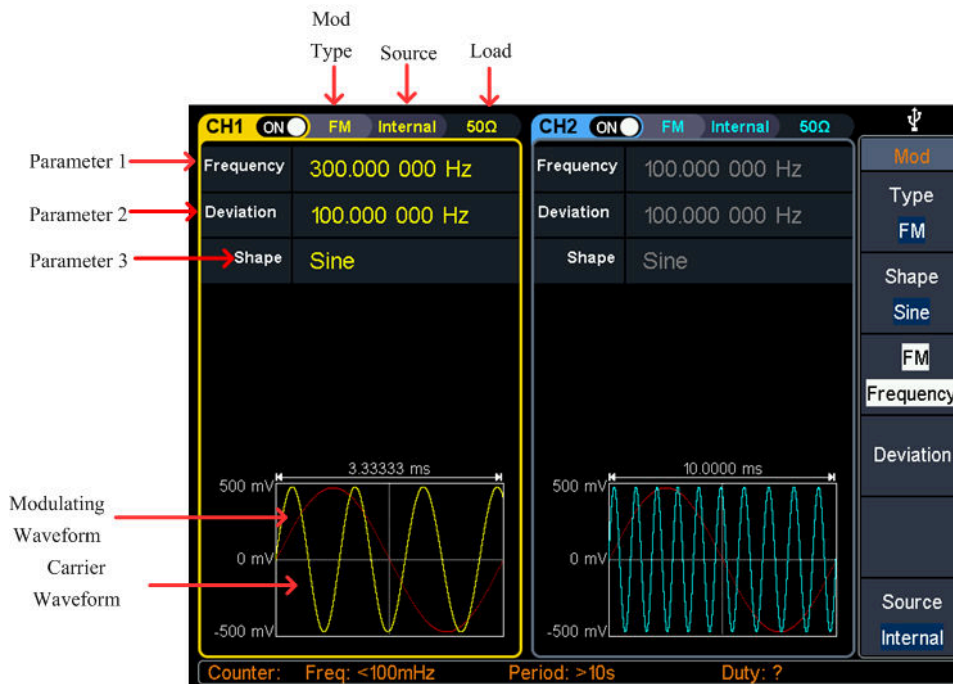





Figure 5-13: FM user interface

### How to set the parameters of FM

- (1) Press the **Mod** function key, then press the **Type** softkey, turn the **knob** to select **FM**, press the **OK** softkey.
- (2) **Select carrier wave shape:**  
The carrier wave can be **Sine**, **Square**, **Ramp**, or **Arbitrary** wave (except DC). Press , , , or  to select a desired carrier wave shape.
- (3) **Set carrier wave parameters:**  
Press the **wave shape key** of the selected carrier wave to display the waveform and parameters of the carrier wave. You can change the parameters of the carrier wave. Press **Mod** to return to the modulation mode interface.
- (4) **Select modulating wave source:**  
Press the **Source** softkey to select the modulating wave source.  
If you select **External**, use the **Mod/FSK/Trig** connector at the rear panel to input the external modulating signal, then skip ahead to **step (7)**.  
If you select **Internal**, continue with the following steps.
- (5) **Select modulating wave shape:**  
Press the **Shape** softkey, then press the **Sine**, **Square**, **Ramp**, **Noise**, or **Arb** softkey to select the modulating wave.
- (6) **Set modulating wave frequency:**  
Press the **FM Frequency** softkey to set the modulating wave frequency. The range is 2 mHz – 1 MHz (for internal source only).
- (7) **Set frequency deviation:**

Frequency deviation is the deviation of the modulating wave frequency relative to the carrier wave frequency. Press the **Deviation** softkey to set the FM frequency deviation. Frequency deviation range:  $2 \text{ mHz} \leq \text{deviation} < \text{upper limit}$  (upper limit is **carrier frequency** or **carrier maximum frequency minus carrier frequency**, the smaller of the two).

## PM (Phase Modulation)

The modulated waveform consists of the carrier wave and the modulating wave. For PM, the phase of the carrier wave varies with the instantaneous voltage of the modulating wave. The PM user interface is shown below.

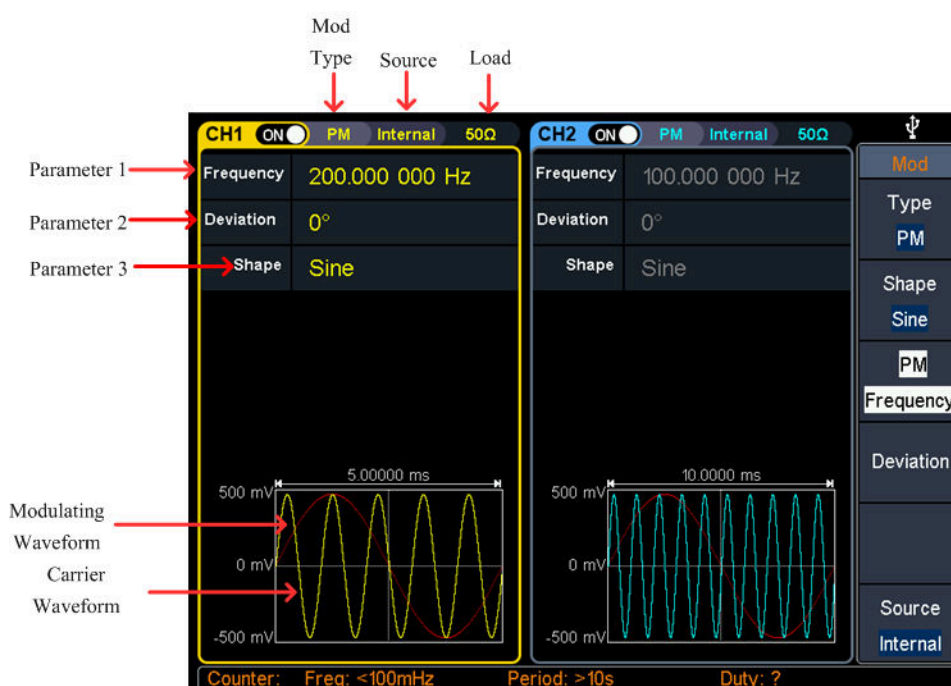





Figure 5-14: PM user interface

### How to set the parameters of PM

- (1) Press the **Mod** function key, then press the **Type** softkey, turn the **knob** to select **PM**, press the **OK** softkey.
- (2) **Select carrier wave shape:**  
The carrier wave can be **Sine**, **Square**, **Ramp**, or **Arbitrary** wave (except DC). Press , , , or  to select a desired carrier wave shape.
- (3) **Set carrier wave parameters:**  
Press the **wave shape key** of the selected carrier wave to display the waveform and parameters of the carrier wave. You can change the parameters of the carrier wave. Press **Mod** to return to the modulation mode interface.
- (4) **Select modulating wave source:**

Press the **Source** softkey to select the modulating wave source.

If you select **External**, use the **Mod/FSK/Trig** connector at the rear panel to input the external modulating signal, then skip ahead to **step (7)**.

If you select **Internal**, continue with the following steps.

**(5) Select modulating wave shape:**

Press the **Shape** softkey, then press the **Sine**, **Square**, **Ramp**, **Noise**, or **Arb** softkey to select the modulating wave.

**(6) Set modulating wave frequency:**

Press the **PM Frequency** softkey to set the modulating wave frequency. The range is 2 mHz – 1 MHz (for internal source only).

**(7) Set phase deviation:**

Phase deviation is the deviation of the modulating wave phase relative to the carrier wave phase. Press the **Deviation** softkey to set the PM phase deviation. The range of phase deviation is from 0° to 180°.

### PWM (Pulse Width Modulation)

The modulated waveform consists of the carrier wave and the modulating wave. For PWM, the pulse width of the carrier Pulse wave varies with the instantaneous voltage of the modulating wave. The PWM user interface is shown below.



Figure 5-15: PWM user interface

### How to set the parameters of PWM

**(1) Set carrier wave shape:**

PWM can only be used to modulate pulse, so the carrier wave must be **Pulse**.

Press  to set the carrier wave shape.

- (2) Press the **Mod** function key, then press the **Type** softkey, turn the **knob** to select **PWM**, press the **OK** softkey.

Note: If **Pulse** wave has not been selected, **PWM** in the menu is unavailable.

- (3) **Set carrier wave parameters:**

Press  to display the waveform and parameters of the carrier wave. You can change the parameters of the carrier wave. Press **Mod** to return to the modulation mode interface.

- (4) **Select modulating wave source:**

Press the **Source** softkey to select the modulating wave source.

If you select **External**, use the **Mod/FSK/Trig** connector at the rear panel to input the external modulating signal, then skip ahead to **step (7)**.

If you select **Internal**, continue with the following steps.

- (5) **Select modulating wave shape:**

Press the **Shape** softkey, then press the **Sine**, **Square**, **Ramp**, **Noise**, or **Arb** softkey to select the modulating wave.

- (6) **Set modulating wave frequency:**

Press the **PWM Frequency** softkey to set the modulating wave frequency. The range is 2 mHz – 1 MHz (for internal source only).

- (7) **Set duty cycle deviation:**

Duty cycle deviation is the deviation (in %) of the modulating wave duty cycle relative to the original pulse duty cycle. Press the **Deviation** softkey to set the PWM duty cycle deviation.

Duty cycle deviation range:  $0\% \leq \text{deviation} \leq \text{upper limit}$  (upper limit is **carrier duty cycle** or **100% minus carrier duty cycle**, the smaller of the two).

### ASK (Amplitude Shift Keying)

Amplitude Shift Keying modulation is a modulation technique that shifts the output signal amplitude between two amplitudes: the carrier amplitude and modulating amplitude. Carrier wave amplitude shifts to the modulating amplitude with the specified ASK rate, and then returns to the original amplitude. The ASK user interface is shown below.

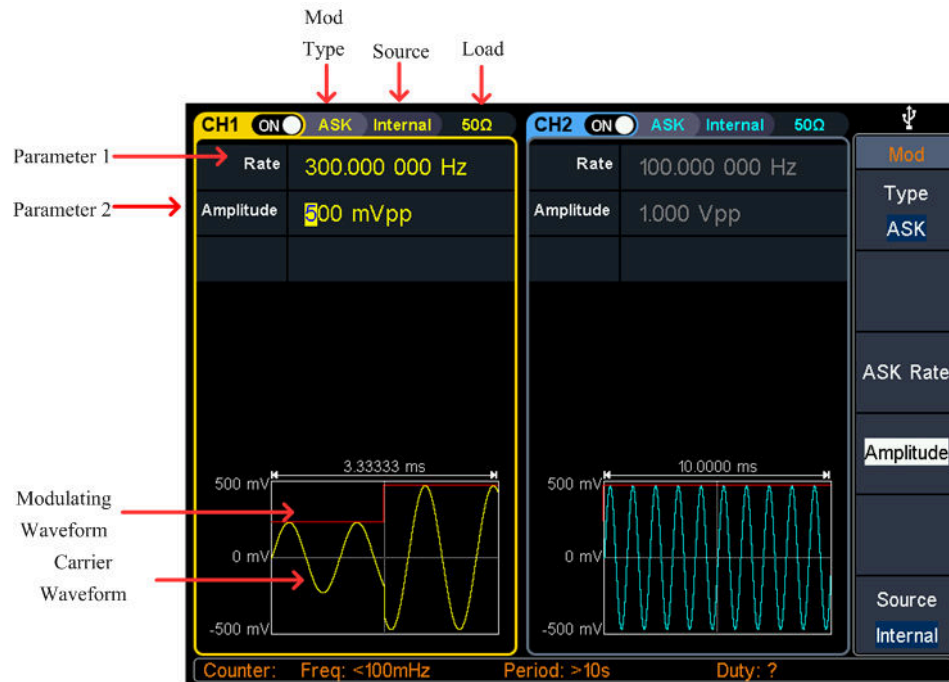





Figure 5-16: ASK user interface

### How to set the parameters of ASK

- (1) Press the **Mod** function key, then press the **Type** softkey, turn the **knob** to select **ASK**, press the **OK** softkey.
- (2) **Select carrier wave shape:**  
The carrier wave can be **Sine**, **Square**, **Ramp**, or **Arbitrary** wave (except DC). Press , , , or  to select a desired carrier wave shape.
- (3) **Set carrier wave parameters:**  
Press the **wave shape key** of the selected carrier wave to display the waveform and parameters of the carrier wave. You can change the parameters of the carrier wave. Press **Mod** to return to the modulation mode interface.
- (4) **Select modulating wave source:**  
Press the **Source** softkey to select **Internal** or **External** as the modulating wave source.
- (5) If you select **Internal**, the modulating wave is set as a Square with 50% duty cycle. Press the **ASK Rate** softkey to set the ASK rate. The rate at which the output amplitude shifts between the carrier amplitude and the modulating amplitude is determined by ASK rate (for internal source only). The range is 2 mHz – 1 MHz.

If you select **External**, use the **Mod/FSK/Trig** connector at the rear panel to input the external modulating signal. Press the **Slope** softkey to switch between **Positive** and **Negative** polarity of the modulating wave to control the output amplitude. Set the slope to **Positive**, the generator would output the greater of the carrier amplitude and modulating amplitude when the external input signal is logic high level, and output the lower when the external input signal is logic



low level. The situation is the opposite when the slope is set to **Negative**.

**(6) Set modulating amplitude:**

Press the **Amplitude** softkey to set the modulating amplitude.

**FSK (Frequency Shift Keying)**

Frequency Shift Keying modulation is a modulation technique that shifts the output signal frequency between two frequencies: the carrier frequency and hop frequency. The shift frequency (FSK rate) is determined by the internal signal level or signal level offered by the **Mod/FSK/Trig** connector at the rear panel. The FSK user interface is shown below.

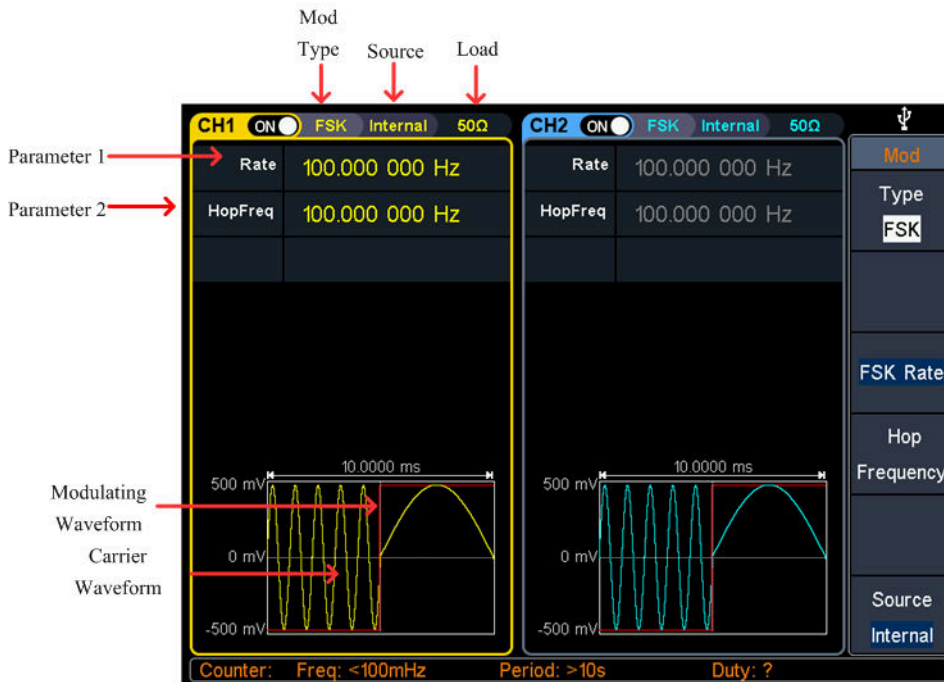





Figure 5-17: FSK user interface

**How to set the parameters of FSK**

- (1) Press the **Mod** function key, then press the **Type** softkey, turn the **knob** to select **FSK**, press the **OK** softkey.
- (2) **Select carrier wave shape:**  
The carrier wave can be **Sine**, **Square**, **Ramp**, or **Arbitrary** wave (except DC). Press , , , or  to select a desired carrier wave shape.
- (3) **Set carrier wave parameters:**  
Press the **wave shape key** of the selected carrier wave to display the waveform and parameters of the carrier wave. You can change the parameters of the carrier wave. Press **Mod** to return to the modulation mode interface.
- (4) **Select modulating wave source:**  
Press the **Source** softkey to select **Internal** or **External** as the modulating wave



source.

- (5) If you select **Internal**, the modulating wave is set as a Square with 50% duty cycle. Press the **FSK Rate** softkey to set the FSK rate. The rate at which the output frequency shifts between the carrier frequency and the hop frequency is determined by FSK rate (for internal source only). The range is 2 mHz – 1 MHz.

If you select **External**, use the **Mod/FSK/Trig** connector at the rear panel to input the external modulating signal. Press the **Slope** softkey to switch between **Positive** and **Negative** polarity of the modulating wave to control the output frequency. Set the slope to **Positive**, the generator would output the carrier frequency when the external input signal is logic low level, and output the hop frequency when the external input signal is logic high level. The situation is the opposite when the slope is set to **Negative**.

- (6) **Set hop frequency:**

Press the **Hop Frequency** softkey to set the hop frequency. The carrier wave frequency shifts to the hop frequency with the specified FSK rate, and then returns to the original frequency.

### PSK (Phase Shift Keying)

Phase Shift Keying modulation is a modulation technique that shifts the output signal phase between two phases: the carrier phase and modulating phase. Carrier wave phase shifts to the modulating phase with the specified PSK rate, and then returns to the original phase. The PSK user interface is shown below.

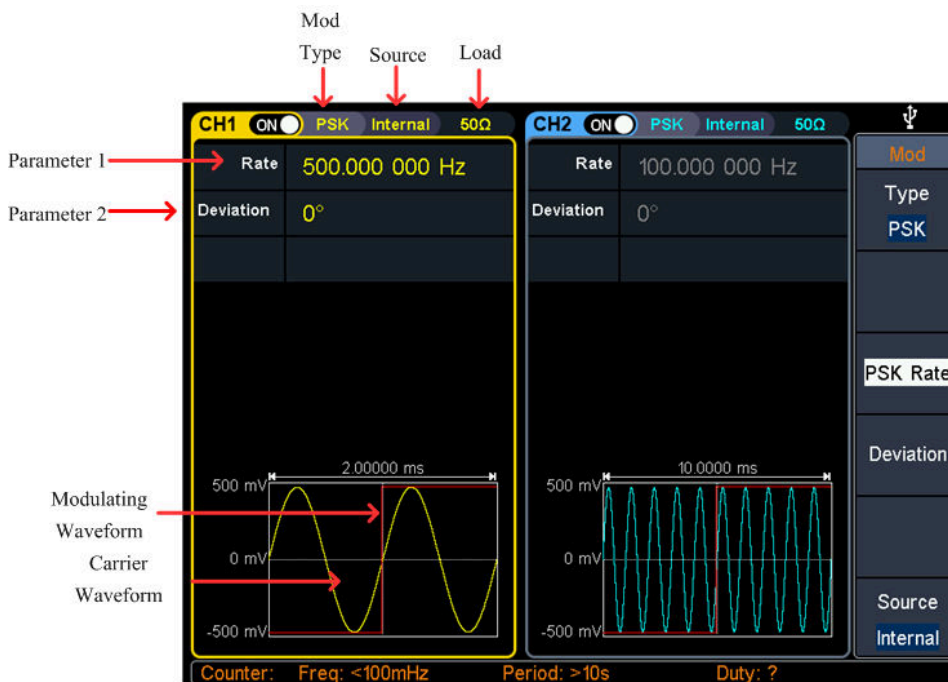





Figure 5-18: PSK user interface

## How to set the parameters of PSK

(1) Press the **Mod** function key, then press the **Type** softkey, turn the **knob** to select **PSK**, press the **OK** softkey.

(2) **Select carrier wave shape:**

The carrier wave can be **Sine**, **Square**, **Ramp**, or **Arbitrary** wave (except DC). Press , , , or  to select a desired carrier wave shape.

(3) **Set carrier wave parameters:**

Press the **wave shape key** of the selected carrier wave to display the waveform and parameters of the carrier wave. You can change the parameters of the carrier wave. Press **Mod** to return to the modulation mode interface.

(4) **Select modulating wave source:**

Press the **Source** softkey to select **Internal** or **External** as the modulating wave source.

(5) If you select **Internal**, the modulating wave is set as a Square with 50% duty cycle. Press the **PSK Rate** softkey to set the PSK rate. The rate at which the output phase shifts between the carrier phase and the modulating phase is determined by PSK rate (for internal source only). The range is 2 mHz – 1 MHz.

If you select **External**, use the **Mod/FSK/Trig** connector at the rear panel to input the external modulating signal. Press the **Slope** softkey to switch between **Positive** and **Negative** polarity of the modulating wave to control the output phase. Set the slope to **Positive**, the generator would output the carrier phase when the external input signal is logic low level, and output the modulating phase when the external input signal is logic high level. The situation is the opposite when the slope is set to **Negative**.

(6) **Set PSK phase deviation:**

Press the **Deviation** softkey to set the modulating phase deviation.

## 3FSK (3 Frequency Shift Keying)

3 Frequency Shift Keying modulation is a modulation technique that shifts the output signal frequency among three preset frequencies: the carrier frequency and two hop frequencies. The shift frequency (3FSK rate) is determined by the internal signal level of the instrument. The 3FSK user interface is shown below.

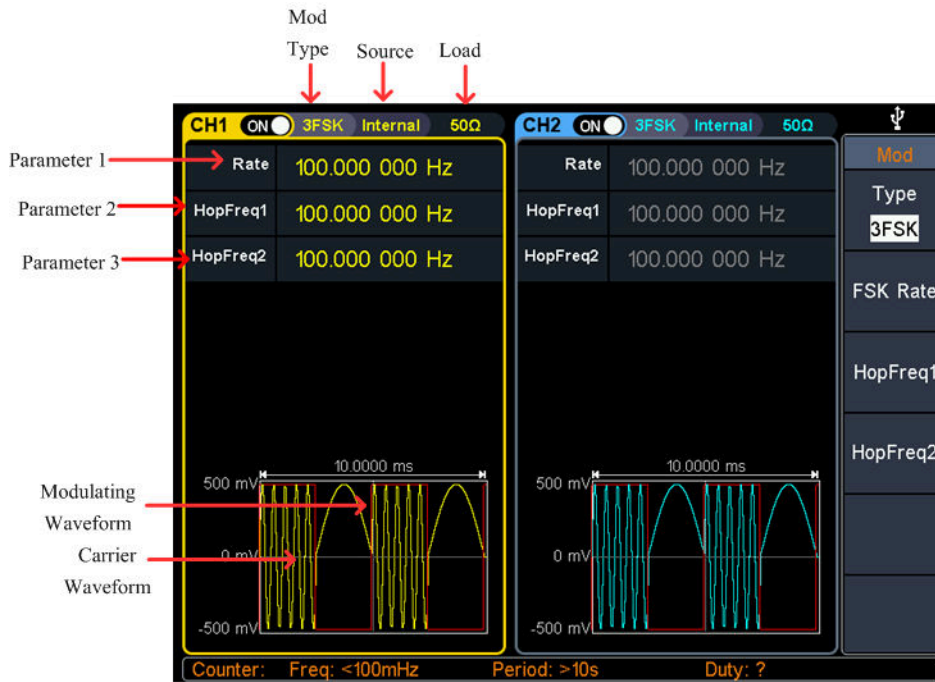





Figure 5-19: 3FSK user interface

### How to set the parameters of 3FSK

- (1) Press the **Mod** function key, then press the **Type** softkey, turn the **knob** to select **3FSK**, press the **OK** softkey.
- (2) **Select carrier wave shape:**  
The carrier wave can be **Sine**, **Square**, **Ramp**, or **Arbitrary** wave (except DC). Press , , , or  to select a desired carrier wave shape.
- (3) **Set carrier wave parameters:**  
Press the **wave shape key** of the selected carrier wave to display the waveform and parameters of the carrier wave. You can change the parameters of the carrier wave. Press **Mod** to return to the modulation mode interface.
- (4) **Modulating wave source:**  
3FSK uses internal modulation source, and the modulating wave is set as a Square with 50% duty cycle.
- (5) **Set 3FSK rate:**  
Press the **FSK Rate** softkey to set the 3FSK rate. The rate at which the output frequency shifts between the carrier frequency and the two hop frequencies is determined by 3FSK rate (for internal source). The range is 2 mHz – 1 MHz.
- (6) **Set hop frequencies:**  
Press the **HopFreq1** and **HopFreq2** softkey to set the two hop frequencies.

## 4FSK (4 Frequency Shift Keying)

4 Frequency Shift Keying modulation is a modulation technique that shifts the output signal frequency among four preset frequencies: the carrier frequency and three hop frequencies. The shift frequency (4FSK rate) is determined by the internal signal level of the instrument. The 4FSK user interface is shown below.

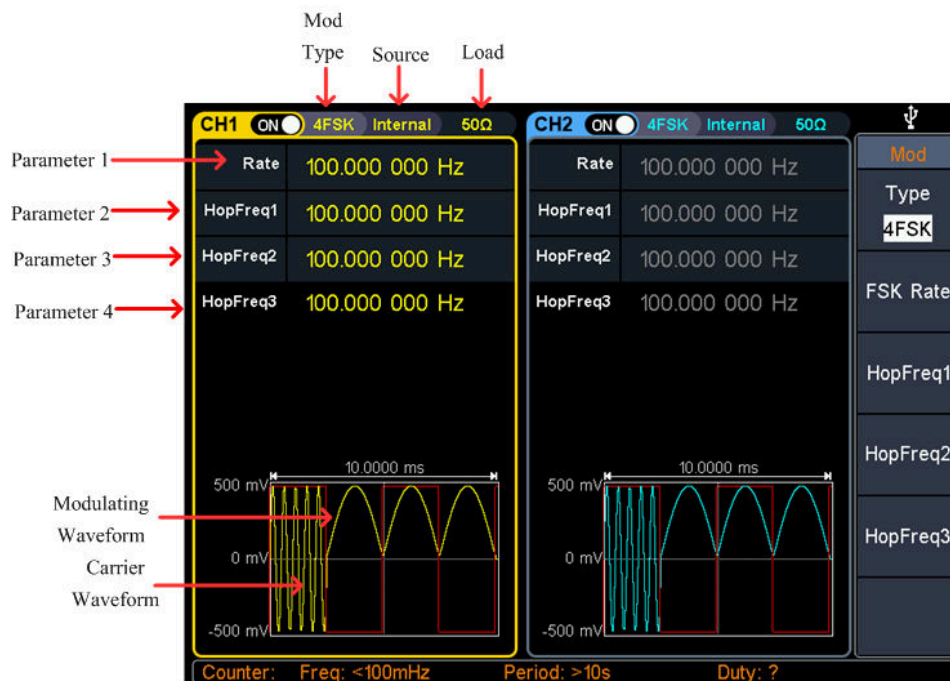





Figure 5-20: 4FSK user interface

### How to set the parameters of 4FSK

- (1) Press the **Mod** function key, then press the **Type** softkey, turn the **knob** to select **4FSK**, press the **OK** softkey.
- (2) **Select carrier wave shape:**  
The carrier wave can be **Sine**, **Square**, **Ramp**, or **Arbitrary** wave (except DC). Press , , , or  to select a desired carrier wave shape.
- (3) **Set carrier wave parameters:**  
Press **the wave shape key** of the selected carrier wave to display the waveform and parameters of the carrier wave. You can change the parameters of the carrier wave. Press **Mod** to return to the modulation mode interface.
- (4) **Modulating wave source:**  
4FSK uses internal modulation source, and the modulating wave is set as a Square with 50% duty cycle.
- (5) **Set 4FSK rate:**  
Press the **FSK Rate** softkey to set the 4FSK rate. The rate at which the output

frequency shifts between the carrier frequency and the three hop frequencies is determined by 4FSK rate (for internal source). The range is 2 mHz – 1 MHz.

**(6) Set hop frequencies:**

Press the **HopFreq1**, **HopFreq2** and **HopFreq3** softkey to set the three hop frequencies.

## BPSK (Binary Phase Shift Keying)

Binary Phase Shift Keying modulation is a modulation technique that shifts the output signal phase between two phases: the carrier phase and modulating phase. Carrier wave phase shifts to the modulating phase with the specified BPSK rate, and then returns to the original phase. The BPSK user interface is shown below.

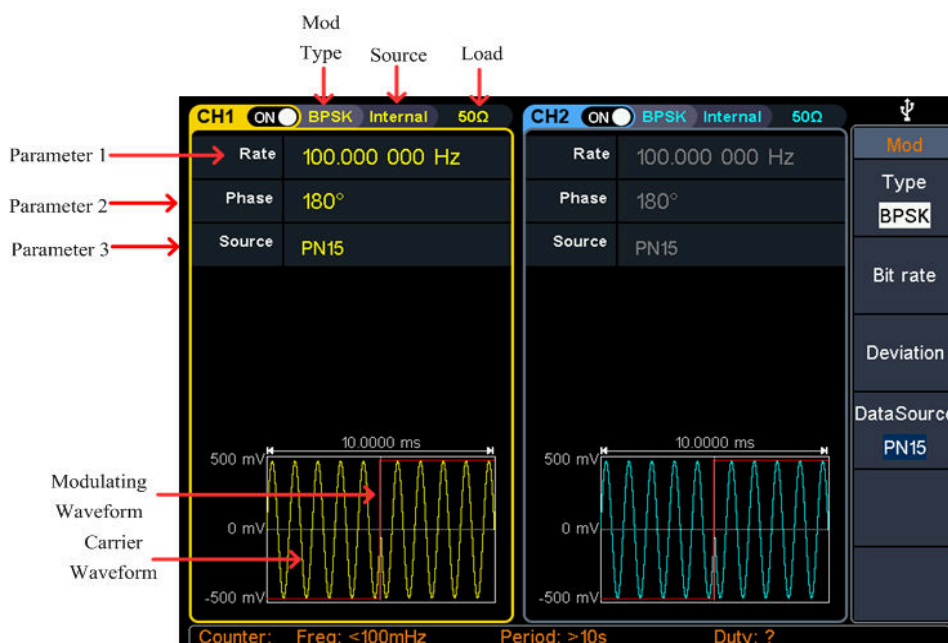





Figure 5-21: BPSK user interface

### How to set the parameters of BPSK

- (1) Press the **Mod** function key, then press the **Type** softkey, turn the **knob** to select **BPSK**, press the **OK** softkey.
- (2) **Select carrier wave shape:**  
The carrier wave can be **Sine**, **Square**, **Ramp**, or **Arbitrary** wave (except DC). Press , , , or  to select a desired carrier wave shape.
- (3) **Set carrier wave parameters:**  
Press the **wave shape key** of the selected carrier wave to display the waveform and parameters of the carrier wave. You can change the parameters of the carrier wave. Press **Mod** to return to the modulation mode interface.

**(4) Select modulating wave source:**

BPSK uses internal modulation source. Press the **DataSource** softkey to select **PN15**, **PN21**, **01 Patt**, or **10 Patt** as the modulating wave source.

**(5) Set BPSK rate:**

Press the **Bit rate** softkey to set the BPSK rate. The rate at which the output phase shifts between the carrier phase and the modulating phase is determined by BPSK rate (for internal source). The range is 2 mHz – 1 MHz.

**(6) Set BPSK phase deviation:**

Press the **Deviation** softkey to set the modulating phase deviation.

## QPSK (Quadrature Phase Shift Keying)

Quadrature Phase Shift Keying modulation is a modulation technique that shifts the output signal phase among four preset phases: the carrier phase and three modulating phases. The shift frequency (QPSK rate) is determined by the internal signal level of the instrument. The QPSK user interface is shown below.

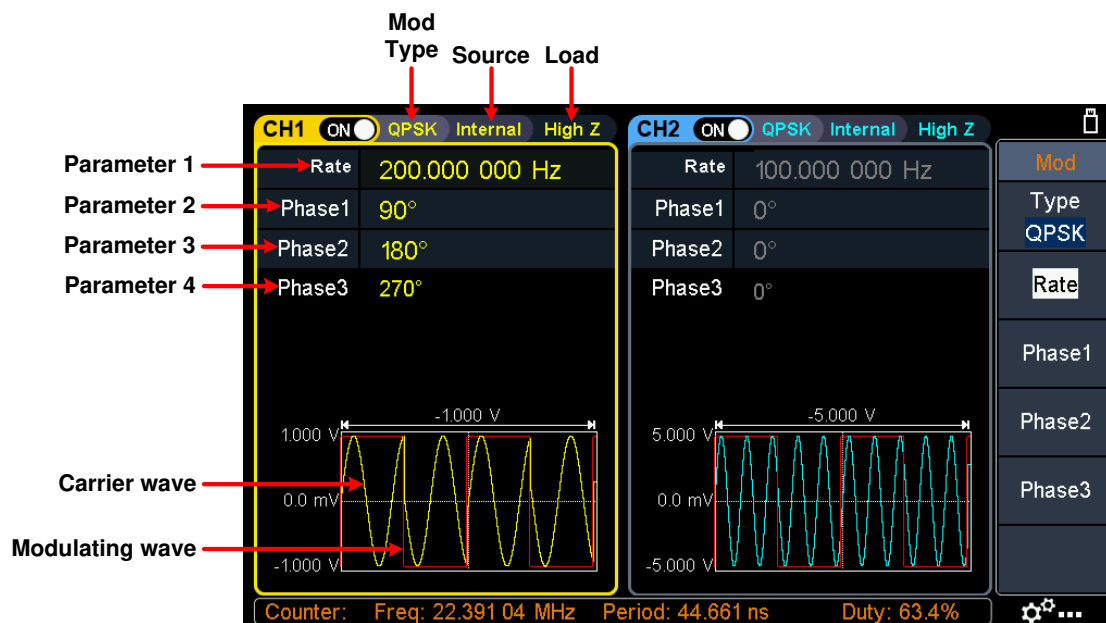





Figure 5-22: QPSK user interface

### How to set the parameters of QPSK

- (1) Press the **Mod** function key, then press the **Type** softkey, turn the **knob** to select **QPSK**, press the **OK** softkey.
- (2) **Select carrier wave shape:**  
The carrier wave can be **Sine**, **Square**, **Ramp**, or **Arbitrary** wave (except DC). Press , , , or  to select a desired carrier wave shape.

**(3) Set carrier wave parameters:**

Press the **wave shape key** of the selected carrier wave to display the waveform and parameters of the carrier wave. You can change the parameters of the carrier wave. Press **Mod** to return to the modulation mode interface.

**(4) Set QPSK rate:**

Press the **Rate** softkey to set the QPSK rate. The rate at which the output phase shifts between the carrier phase and the modulating phase is determined by QPSK rate (for internal source). The range is 2 mHz – 1 MHz.

**(5) Set the modulating phases:**

Press the **Phase1**, **Phase2** and **Phase3** softkey to set the modulating phases respectively. The range is 0° to 360°.

**OSK (Oscillation Shift Keying)**

Oscillation Shift Keying modulation is a modulation technique that the generator to output a sine signal with intermittent oscillation. The start-oscillation and stop-oscillation of the internal crystal oscillator are controlled by the internal signal level of the instrument. When the internal crystal oscillator starts to oscillate, the instrument starts to output the carrier waveform and when the internal crystal stops oscillating, the output stops. The OSK user interface is shown below.

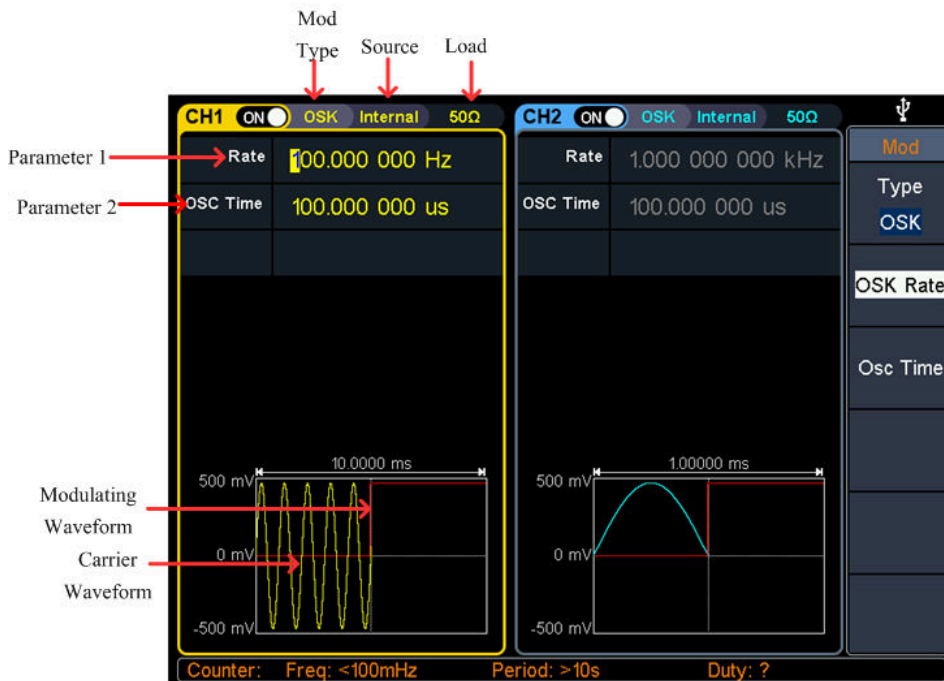



Figure 5-23: OSK user interface

**How to set the parameters of OSK**

**(1) Set carrier wave shape:**



OSK carrier wave can only be sine wave. Press  to set the carrier wave shape.

- (2) Press the **Mod** function key, then press the **Type** softkey, turn the **knob** to select **OSK**, press the **OK** softkey.

Note: If **Sine** wave has not been selected, **OSK** in the menu is unavailable.

- (3) **Set carrier wave parameters:**

Press  to display the waveform and parameters of the carrier wave. You can change the parameters of the carrier wave. Press **Mod** to return to the modulation mode interface.

- (4) **Select modulating wave source:**

OSK uses internal modulation source, and the modulating wave is set as a Square with 50% duty cycle.

- (5) **Set OSK rate:**

Press the **OSK Rate** softkey to set the OSK rate. The intermittence time and oscillate time of the output signal is determined by OSK rate (for internal source). The range is 2 mHz – 1 MHz.

- (6) **Set oscillate time:**

Oscillate time is the oscillation period of internal crystal oscillator. The settable range of the oscillate period is related to the OSK rate currently selected. Press the **Osc Time** softkey to set the oscillate time. The range is 8ns - 249.75s.

## SUM (Sum Modulation)

The modulated waveform consists of the carrier wave and the modulating wave. For SUM, the amplitude of the carrier wave varies with the instantaneous voltage of the modulating wave. The SUM user interface is shown below.

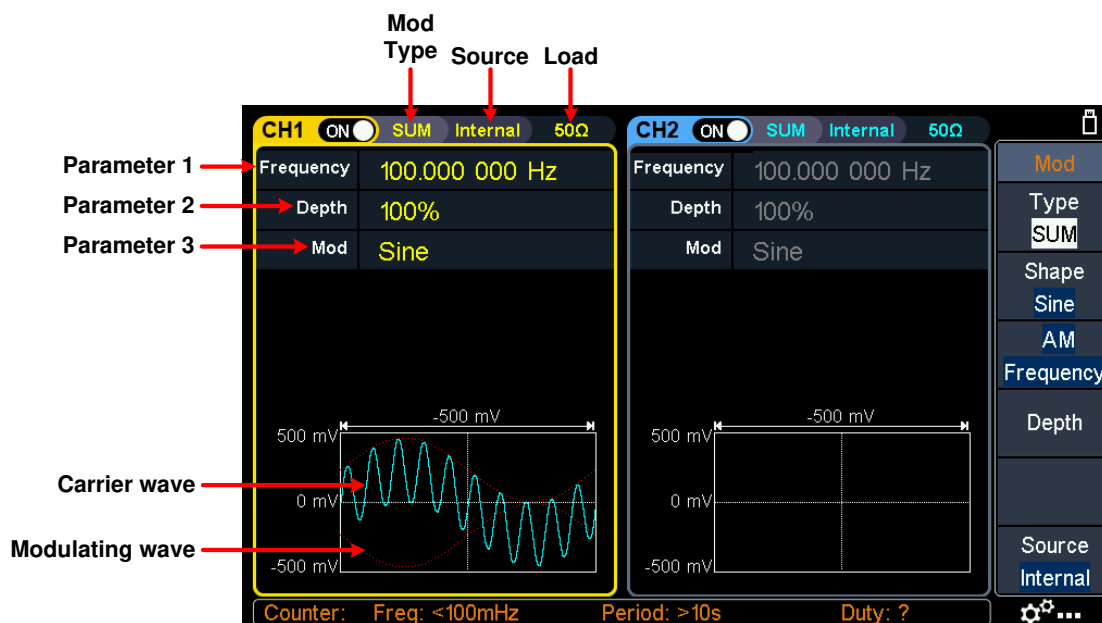





Figure 5-24: SUM user interface



## How to set the parameters of SUM

- (1) Press the **Mod** function key, then press the **Type** softkey, turn the **knob** to select **SUM**, press the **OK** softkey.
- (2) **Select carrier wave shape:**  
The carrier wave can be **Sine**, **Square**, or **Ramp**. Press , , or  to select a desired carrier wave shape.
- (3) **Set carrier wave parameters:**  
Press the **wave shape key** of the selected carrier wave to display the waveform and parameters of the carrier wave. You can change the parameters of the carrier wave. Press **Mod** to return to the modulation mode interface.
- (4) **Select modulating wave source:**  
Press the **Source** softkey to select the modulating wave source.  
If you select **External**, use the **Mod/FSK/Trig** connector at the rear panel to input the external modulating signal, the SUM setting is completed.  
If you select **Internal**, continue with the following steps.
- (5) **Select modulating wave shape:**  
Press the **Shape** softkey, then press the **Sine**, **Square**, **Ramp**, **Noise**, or **Arb** softkey to select the modulating wave.
- (6) **Set modulating wave frequency:**  
Press the **AM Frequency** softkey to set the modulating wave frequency. The range is 2 mHz – 1 MHz (for internal source only).
- (7) **Set modulation depth:**  
Press the **Depth** softkey to set the modulation depth. The range is 0% - 100%.

## Generate Sweep (Sweep)

In sweep mode, the generator varies its output from the start frequency to the stop frequency within the specified sweep time. Sweep can be generated by **Sine**, **Square**, **Ramp** or **Arbitrary** wave (except DC).

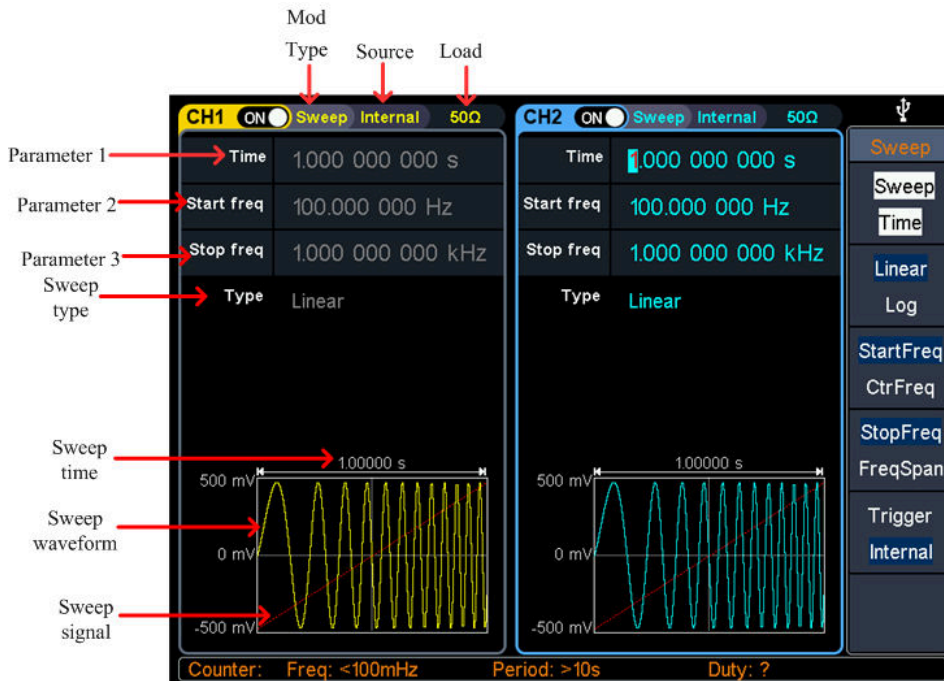







Figure 5-25: Sweep mode user interface

### How to set the parameters of Sweep

- (1) When the output signal is **Sine**, **Square**, **Ramp** or **Arbitrary** wave (except DC), press the front panel **Sweep** function key to enter the sweep mode (the backlight of the key lights up).
- (2) Press , , , or  to select the sweep waveform. For example, when selecting a sine wave, press  to display the sweep waveform and parameters, and change the parameters. For details, please refer to *Output Sine Wave* on page 10. Press  or **Sweep** to return to the sweep mode interface.
- (3) Press the **Sweep Time** softkey to set the sweep time, the time span of the sweep for which the frequency changes from the start frequency to stop frequency. The range is from 1ms to 500s.
- (4) Press the **Type** softkey to switch the sweep type.
  - When **Linear** is selected, the output frequency of the instrument varies linearly during the sweep.
  - When **Log** is selected, the output frequency of the instrument varies in a logarithmic fashion during the sweep.
  - When **Step** is selected, the output frequency of the instrument steps from start

frequency to stop frequency. The duration of the output signal on each frequency point is determined by sweep time and step number. Press the **Step** softkey to set the desired step number.

- (5) Start frequency and stop frequency are the upper and lower limits of the frequency for frequency sweep. The generator sweeps from the start frequency to the stop frequency and then returns back to the start frequency. Press the **StartFreq/CtrFreq** softkey to highlight **StartFreq**, note that **StopFreq** in **StopFreq/FreqSpan** is also highlighted, input the desired frequencies.

You can also set the frequency boundaries of frequency sweep through center frequency and frequency span.

$$\text{Center Frequency} = (\text{Start Frequency} + \text{Stop Frequency}) / 2$$

$$\text{Frequency Span} = \text{Stop Frequency} - \text{Start Frequency}$$

Press the **StartFreq/CtrFreq** softkey to highlight **CtrFreq**, note that **FreqSpan** in **StopFreq/FreqSpan** is also highlighted, input the desired frequencies.

For different instrument models and different waveforms, the setting ranges of frequency are different. For detailed information, please refer to **Sweep characteristics** in *Specification* on page 68.

- (6) Press the **Trigger** softkey to select the trigger source.

**Internal** means using the internal trigger source.

**External** means using the **Mod/FSK/Trig** connector at the rear panel to input the external trigger signal. A sweep will be generated once the connector gets a TTL pulse with specified polarity. To set the TTL pulse polarity, press the **Slope** softkey to switch between **Positive** and **Negative**.

**Manual** means using manual trigger. In sweep interface, each time you press the **Trigger** button under the current channel on the front panel, a sweep will be generated.

## Generate Burst (Burst)

Press the **Burst** key on the front panel to generate versatile waveforms in burst. Burst can last for certain times of waveform cycle (N-Cycle Burst), or to be controlled by external gated signals (Gated Burst). Burst can apply to **Sine**, **Square**, **Ramp**, **Pulse**, **Noise** (only for gated burst) and **Arbitrary** waveforms.

## Glossary

**Burst:**

The set of pulses transmitted together is called a "burst". The various signal generators are commonly referred to as the BURST function.

**N cycle burst:**

Contains a specific number of waveform cycles, each of which is initiated by a trigger event.

**Gated burst:**





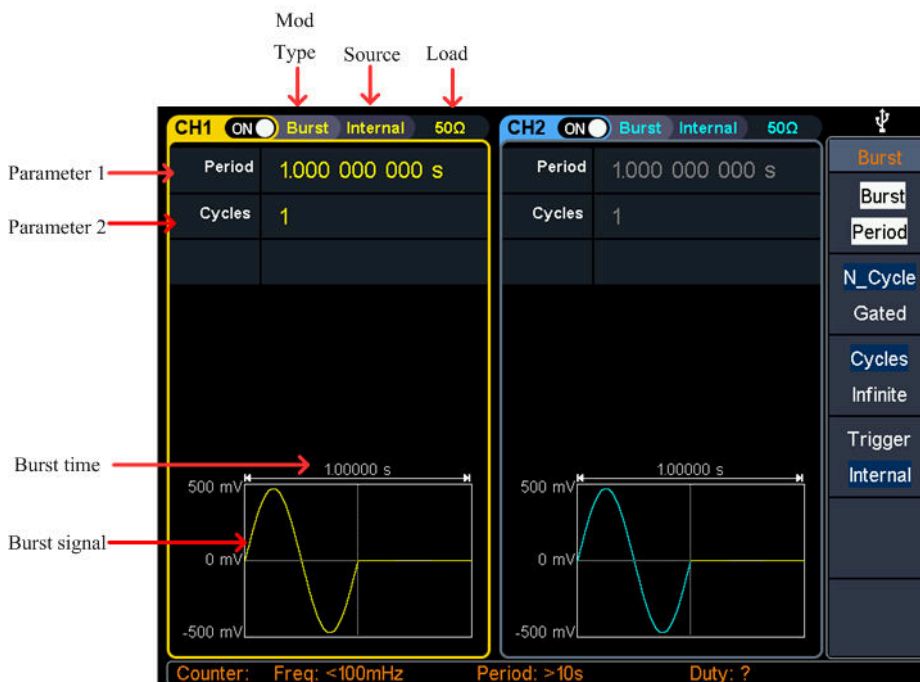

Use external department signals to control when waveform burst waveforms are active

## Set N-Cycle Burst

In N Cycle mode, the generator will output waveform with specified number of cycles after receiving trigger signal.



**Figure 5-26: N-Cycle burst user interface**



- (1) When the output signal is **Sine, Square, Ramp, Pulse** or **Arbitrary** wave (except DC), press the front panel **Burst** function key to enter the burst mode (the backlight of the key lights up).
- (2) Press , , , , or  to select the burst waveform. For example, when selecting a sine wave, press  to display the burst waveform and parameters, and change the parameters. For details, please refer to *Output Sine Wave* on page 10. Press  or **Burst** to return to the burst mode interface.

**Note:** Before configuring the waveform parameters, you must first select the

channel you want to configure. Press **CH1** or **CH2** to select the corresponding channel, and the corresponding channel area in the user interface will light up.

- (3) Press the **N\_Cycle/Gated** softkey to highlight **N\_Cycle**.
- (4) Press the **Cycles/Infinite** softkey to highlight **Cycles**, input the number of cycles, which is the number of waveform cycles to be output for each N-cycle pulse train. The range is from 1 to 1 000 000.

When **Infinite** is selected, the cycle number of the waveform is set as an infinite value. The generator outputs a continuous waveform after receiving trigger signal.

**Note:** In burst mode, the upper limit of the carrier frequency is half of the max frequency of the original carrier. Taking a Sine wave as an example, the maximum frequency is 100 MHz. Press , and set the carrier to 100 MHz, then press the **Burst** mode key, then press , you can see the carrier frequency is changed to 50 MHz.

---

**Note:**

- If needed, Burst Period will increase to cater to the specific number of cycles.
  - For an infinite-cycle Burst, **External** or **Manual** Trigger is needed to activate burst.
- 

- (5) Burst trigger source could be internal, external or manual. The generator will generate a burst output when a trigger signal is received and then wait for the next trigger. Press the **Trigger** to select the source.

**Internal** means using the internal trigger source. The generator can only output N-cycle burst and the burst frequency is determined by the burst period. Burst period is only available when **Cycles** and **Internal** trigger is highlighted. Press the **Burst Period** softkey to set the burst period, which is the time from the start of a burst to the start of the next burst. The range is from 20 ns to 500 s (Min = Cycles \* Period).

**External** means using the **Mod/FSK/Trig** connector at the rear panel to input the external trigger signal. A burst will be generated once the connector gets a TTL pulse with specified polarity. To set the TTL pulse polarity, press the **Slope** softkey to switch between **Positive** and **Negative**.

**Manual** means using manual trigger. In N-cycle burst interface, each time you press the **Trigger** button under the current channel on the front panel, a burst will be generated.

### Set Gated Burst









In gated burst mode, the generator controls the waveform output according to the external signal level from the **Mod/FSK/Trig** connector at the rear panel. Gated burst could only be triggered by external trigger source. Waveform functions which

support gated burst are **Sine**, **Square**, **Ramp**, **Pulse**, **Noise** and **Arbitrary** waveforms (except DC).



**Figure 5-27: Gated burst user interface**

(1) When the output signal is **Sine**, **Square**, **Ramp**, **Pulse**, **Noise** or **Arbitrary** wave (except DC), press the front panel **Burst** function key to enter the burst mode (the backlight of the key lights up).

(2) Press , , , , , or  to select the burst waveform. For example, when selecting a sine wave, press  to display the burst waveform and parameters, and change the parameters. For details, please refer to *Output Sine Wave* on page 10. Press  or **Burst** to return to the burst mode interface.

**Note:** Before configuring the waveform parameters, you must first select the channel you want to configure. Press **CH1** or **CH2** to select the corresponding channel, and the corresponding channel area in the user interface will light up.

(3) Press the **N\_Cycle/Gated** softkey to highlight **Gated**.

(4) Press the **Polarity** softkey to set the gated polarity as **Positive** (or **Negative**). The generator outputs burst waveform only when the gated signal is positive (or negative). When the gated signal is true, the generator outputs a continuous waveform; when the gated signal is false, the generator completes the current period, and then stops and holds on the voltage level corresponding to the initial burst phase of the selected waveform. For Noise waveform, the output will stop immediately once the gated signal becomes false.

## Counter

The frequency counter measures signals in the frequency range from 100 mHz to 200 MHz. The **10MHz In/Out/Counter** connector on the rear panel is used by default to receive the frequency counter input signal. The frequency meter works from the start, unless the connector is set to an external clock input or clock output.

- (1) Press the front panel **Counter** function key to enter the frequency counter interface.
- (2) Connect the signal to be tested to the **10MHz In/Out/Counter** connector on the rear panel.
- (3) Set the frequency counter:
  - Press the **Coupling** softkey to switch between AC and DC, to set the coupling mode of the input signal.
  - Press the **Sensitivity** softkey to toggle between Low, Middle or High. For small amplitude signals, the sensitivity is selected to be middle or high. For low frequency large signals or signals with slow rising edges, low sensitivity is selected and the measurement results are more accurate.
  - Press the **HFR** softkey to toggle On or Off high frequency rejection. High-frequency rejection can be used to filter high-frequency factors when measuring low-frequency signals, improving measurement accuracy. When measuring low frequency signals with a frequency less than 1 kHz, turn on high frequency rejection to filter out high frequency noise interference; turn off high frequency rejection when measuring high frequency signals with frequencies greater than 1 kHz.
  - Press the **Trigger Level** softkey. Turn the **knob** to change the current cursor position value, press the arrow keys to move the cursor left or right; or use the **numeric keypad** to enter a value and then select the desired unit from the right menu. The trigger level ranges from -2.5 V to 2.5 V.

After the setting is completed, the frequency counter will measure the signal to be tested at the current setting. If the reading is unstable, repeat the above adjustment until the display is stable.



- (4) The frequency, period, duty cycle, positive pulse width, and negative pulse width can be viewed on the frequency meter interface. If it is not currently in frequency counter interface, the frequency, period and duty cycle can be viewed in the frequency counter bar at the bottom of the screen.

## Utility Function Setting

Press the front panel **Utility** function key to enter the utility menu. You can set the parameters of the generator such as: display settings, CH1/2 settings, I/O setup, and system settings. Press **Utility** again to exit the utility menu.



## Display Settings

### Brightness Control

- (1) Press the front panel **Utility** function key, press the **Display** softkey.
- (2) Press the **Backlight** softkey to select **Backlight**.
- (3) Turn the **knob** to adjust the value on the current cursor, use the / direction key to move cursor left or right, or use the **numeric keypad** to enter the parameter and then select % as unit. The range is from 0% to 100%.

### Screen Saver

If there is no operation within the set screen saver time, the screen enters the protection mode (minimize screen brightness to protect the screen and save energy). Press any key (except the power button) to restore the brightness before entering the screen saver.

- (1) Press the front panel **Utility** function key, press the **Display** softkey.
- (2) Press the **ScrSaver** softkey to select **On** or **Off**.
- (3) At **On** status, you can set the screen saver time. Turn the **knob** to adjust the value on the current cursor, use the / direction key to move cursor left or right, or use the **numeric keypad** to enter the parameter and then select Minute as unit. The screen saver time range is 1 to 999 minutes.

### Separator

The user can set the separator of the screen display data.

- (1) Press the front panel **Utility** function key, press the **Display** softkey.
- (2) Press the **Separator** softkey to toggle between **Comma**, **Space**, and **Off**.



Taking the frequency parameter as an example:

Comma 

Space 



Off 

### Date

- (1) Press the front panel **Utility** function key, press the **Display** softkey.
- (2) Press the **Date** softkey to select **Date**.
- (3) Turn the **knob** to adjust the value on the current cursor, use the / direction key to move cursor left or right, or use the **numeric keypad** to enter the value.



### Contrast

- (1) Press the front panel **Utility** function key, press the **Display** softkey.
- (2) Press the **Contrast** softkey to select **Contrast**.
- (3) Turn the **knob** to adjust the value on the current cursor, use the / direction key to move cursor left or right, or use the **numeric keypad** to enter the parameter and then select % as unit. The range is from 0% to 100%.

### CH1/2 Settings

#### Sync

The generator can output the sync signals of basic waveforms (except noise), arbitrary waveforms (except DC), harmonics, sweep signal, burst signal, and modulated signal from a single channel or two channels at the same time. This sync signal is output from the **Sync** connector at the front panel.

The steps to enable or disable sync signal at the **Sync** connector:

- (1) Press the **Utility** function key, press the **CH1/2 Set** softkey.
- (2) Press the **CH1 Sync** or **CH2 Sync** softkey, press it again to toggle between **On** and **Off**. The default is "On", which sends the sync signal to the **Sync** connector.

When the sync signal is disabled, the output level at the **Sync** connector is logic low.

#### Sync signals of various waveforms

- For sine, square, ramp and pulse waves, the sync signal is a square wave with a 50% duty cycle. When the waveform output is positive, the sync signal is TTL high with respect to the 0V voltage (or DC offset value). When the waveform output is negative, the sync signal is TTL low relative to the 0V voltage (or DC offset value).
- For arbitrary waveform, the sync signal is a square wave with a variable duty cycle. When the output waveform amplitude reaches a certain value, the sync signal is TTL high.
- For harmonics, the sync signal is referenced to the harmonic order and is a square wave with a variable duty cycle. When the output waveform amplitude is positive, the sync signal is TTL high.
- For AM, FM, PM, and PWM, for internal modulation, the sync signal is referenced to the modulation frequency, and the sync signal is a square wave with a 50% duty cycle. In the first half of the modulation waveform, the sync signal is TTL high. When external modulation is performed, there is no sync signal output.
- For ASK, FSK, PSK, BPSK, QPSK, 3FSK, 4FSK, the synchronization signal is referenced to the keying frequency, and the synchronization signal is a square wave with a duty cycle of 50%. There is no sync signal output during external modulation.

- For OSK, the sync signal is referenced to the keyed frequency and the sync signal is a square wave with a 50% duty cycle. When the internal crystal oscillator starts, the sync signal is TTL high.
- For N-cycle bursts, the sync signal is TTL high at the beginning of the burst. At the end of the specified number of cycles, the sync signal is TTL low (if the waveform has an associated start phase, it may not be a zero crossing). For an infinite count pulse train, the sync signal is the same as the sync signal of the continuous waveform.
- For external gated bursts, the sync signal follows its gate signal. Note: This signal does not become TTL low until the end of the last cycle (if the waveform has an associated starting phase, it may not be a zero crossing).

### Load

For either of **Out1** and **Out2** connector at the front panel, the generator has a 50Ω fixed serial output impedance. If the actual load does not match the specified value, the voltage level displayed would not match the voltage level of the component under test. This function is used to match the displayed voltage with the expected one.

**The step to set the CH1 or CH2 load value is as follows:**

- (1) Press the **Utility** function key, press the **CH1/2 Set** softkey.
- (2) Press the **CH1Load** or **CH2Load** softkey, press it again to select **High Z** or **\* ohm** ("\*" represents a value, the default is 50Ω).
- (3) To change the load value, after selecting **\* ohm**, turn the **knob** to adjust the value on the current cursor, use the **←/→** direction key to move cursor left or right, or use the **numeric keypad** to enter the parameter and then select unit. The load range is 1ohm to 10kohm.

---

**Warning:** Setup the correct load for right application.

---

### I/O Setup

The generator is configured with USB and LAN interfaces and supports users to configure the interface settings for remote communication. Press **Utility** → **I/O Setup** to open the I/O setting menu, and set the USB device type or the LAN interface setting for remote communication.

#### USB Device Type

The user can set the communication protocol type of the USB Device interface at the rear panel.

- (1) Press the front panel **Utility** function key, press the **I/O Setup** softkey.
- (2) Press the **USBDEV** softkey to toggle between **PC** and **USBTMC**.
  - **PC:** This is the internal communication protocol. Select this option when

connecting to the Waveform Editor software via the USB Device interface. For details, refer to *Using USB Port* on page 64.

- **USBTMC:** Select this option when you need to use the USBTMC communication protocol standard.

### Network Setting

The user can examine network status and configure network settings.

- (1) Press the front panel **Utility** function key, press the **I/O Setup** softkey.
- (2) Press the **Network setting** softkey to go to the submenu: **IP Address, Gateway, Subnet mask, Port**. The physical **Mac address** displayed on the interface cannot be modified.
  - Press the **IP Address** softkey to select **IP Address**. Use the numeric keypad and direction keys to enter the desired IP address. The IP address format is nnn.nnn.nnn.nnn, where nnn ranges from 0 to 255. It is recommended that you acquire an available IP address from your network administrator.
  - Press the **Gateway** softkey to select **Gateway**. Use the numeric keypad and direction keys to enter the desired gateway. The gateway format is nnn.nnn.nnn.nnn, where nnn ranges from 0 to 255. It is recommended that you acquire an available gateway from your network administrator.
  - Press the **Subnet mask** softkey to select **Subnet mask**. Use the numeric keypad and direction keys to enter the desired subnet mask. The subnet mask format is nnn.nnn.nnn.nnn, where nnn ranges from 0 to 255. It is recommended that you acquire an available subnet mask from your network administrator.
  - Press the **Port** softkey to select the **Port**. Use the numeric keypad and direction keys to enter the desired port, which ranges from 0001 to 4000.
- (3) After setting the network parameters of the generator, you need to wait for 2 seconds or more to restart the instrument, the current settings of the LAN parameters will take effect. For details, refer to *Using LAN Port* on page 64.

### System Settings

#### Language

- (1) Press the front panel **Utility** function key, press the **System** softkey.
- (2) Press the **Language** softkey to switch the display language.

#### Beeper

When the beeper is turned on, the beeper sounds when users operate the front panel or when an error occurs.

- (1) Press the front panel **Utility** function key, press the **System** softkey.
- (2) Press the **Beeper** softkey to toggle between **On** or **Off**.

### Clock Source

The generator provides an internal 10MHz clock source and can receive the external clock source from the **10MHz/In/Out/Counter** connector at the rear panel. It can also output an internal clock source from the **10MHz/In/Out/Counter** connector for other devices.

---

#### Note:

The amplitude range of the **10MHz In/Out/Counter** input signal is 1 Vpp to 3.3 Vpp.

---

- (1) Press the front panel **Utility** function key, press the **System** softkey.
- (2) Press the **CLK Ref** softkey to toggle between **Internal** and **External**.

#### Note:

The clock source defaults to the internal clock source. When an external clock source is required, this function is switched to external. At this time, the clock output is turned off forcibly.

### Clock Output

- (1) Press the front panel **Utility** function key, press the **System** softkey.
- (2) Press the **CLK Output** softkey to toggle between **On** and **Off**.

#### Note:

When the clock source output is turned on, the clock source must be switched to internal, and the counter function stops after the clock output is turned on.

### Firmware Update

- (1) Press the front panel **Utility** function key, press the **System** softkey.
- (2) Plug the USB storage device into the USB connector on the front panel of the instrument.  
**Note:** If the USB storage device is not inserted, the **Update firmware** menu is disabled.
- (3) Press the **Update firmware** softkey, turn the **knob** to select **USBDEVICE**, press the **Enter** softkey to enter the USB storage device to browse files.
- (4) Turn the **knob** to select the downloaded firmware file, and press the **Execute** softkey to perform firmware upgrade.

#### Note:

The firmware file name is as follows: **xxx model \_Vx.x.x version.upp**.

If the update process fails, an error code will be displayed on the screen. The following table lists the errors that may occur during the update process.

Error code	Error message
2	File size too large
3	Error reading firmware file
4	CRC (Cyclic Redundancy Check) error
5	Type flag error in the firmware file
6	The firmware version of the instrument can not be updated to the firmware version of the file.
7	The instrument model does not match with the model of the firmware file

## Edit the Arbitrary Wave (Edit)

Press the **Edit** function button on front panel to enter the arbitrary wave edit interface.

**(1) Set the wave points:** Press the **Points** softkey, turn the **knob** to adjust the value or use the numeric keypad, and press the unit softkey. Range between 2 to 100,000.

**(2) Select the template:**

Press the **Basic Template** softkey to select Blank, Sine wave, Square wave, Ramp wave, and Noise.

Press the **Arb Template** softkey to select a built-in waveform as template.

**(3) Edit the wave points:** Press **Edit Points** to enter the wave points menu.

- Select **Points**, input the number of point to be edited.
- Select **Voltage**, input the voltage of the point.
- Repeat this step to set all the points.
- Press **Write** to enter the file system interface.

If you want to save the waveform to the internal memory, select INTER and press **Enter** softkey. Turn the knob to select one of the USER files (EditMemory cannot be selected) and press the **Save** softkey. (The file size is displayed on the right side of the USER file. If 0B is displayed, it means the file is empty.)

Description: EditMemory is a temporary data space created, saved, edited or recalled by any arbitrary wave. Saving the waveform is to save the data of this space to the user-specified location (EditMemory is in the memory and never empty). The data in this space is changed after an arbitrary waveform is called, a new waveform is created, or a related programming command is received.

- If you want to save to a USB storage device, you need to plug the USB storage device into the front panel USB port. Turn the knob to select USBDEVICE. Press the **Enter** softkey and the instrument will list the directories of the folders and files in the USB storage device. You can turn the knob to select a folder or file. Press the **Enter** softkey to enter the currently selected folder. To return to the parent directory, press the **Back** softkey. After selecting the storage path, press the **SaveAs** softkey and the input keyboard appears on the screen. Turn the knob to select a character. Press the **ABC/abc** softkey to toggle the case of keyboard characters. Press the **Select** softkey to enter the current character. Press the **Delete** softkey to delete the last character that has been entered. Press the **Done** softkey to finish editing and the waveform will be saved in the bin file format under the current path.

### File Store System (Store)

The storage location is divided into the internal storage (INTER) and the USB device storage (USBDEVICE). When a USB device is connected, the main interface will show "USBDEVICE" and "INTER". Otherwise, the main interface will show "INTER" only.

The internal memory can store 32 arbitrary waveform data.

Press the front panel **Store** function key to enter the file system.

### Save the current arbitrary wave

- (1) Press the  Arbitrary Wave button to enter the Arbitrary Wave menu and configure the waveform parameters.
- (2) Press the front panel **Store** function key to enter the file system.
  - If you want to save the current arbitrary waveform to the internal memory, select **INTER** and press the **Arb file** softkey. Turn the knob to select one of the USER files (EditMemory cannot be selected) and press the **Save** softkey. (The file size is displayed on the right side of the USER file. If 0B is displayed, it means the file is empty.)

**Description:** EditMemory is a temporary data space created, saved, edited or recalled by any arbitrary wave. Saving the waveform is to save the data of this space to the user-specified location (EditMemory is in the memory and never empty). The data in this space is changed after an arbitrary waveform is called, a new waveform is created, or a related programming command is received.

- If you want to save to a USB storage device, you need to plug the USB storage device into the front panel USB interface. Turn the knob to select

**USBDEVICE**. Press the **Arb file** softkey and the instrument will list the directories of the folders and files in the USB storage device. You can turn the knob to select a folder or file. Press the **Enter** softkey to enter the currently selected folder. To return to the parent directory, press the **Back** softkey. After selecting the storage path, press the **SaveAs** softkey and the input keyboard appears on the screen. Turn the knob to select a character. Press the **ABC/abc** softkey to toggle the case of keyboard characters. Press the **Select** softkey to enter the current character. Press the **Delete** softkey to delete the last character that has been entered. Press the **Done** softkey to finish editing and the waveform will be saved in the bin file format under the current path.

### Bring up arbitrary wave files in internal/external memory

Press the front panel **Store** function key to enter the file system.

- To call up the waveform file in the internal memory, select **INTER** under the memory selection interface and press the **Arb file** softkey. Turn the knob to select a file and press the **CallOut** softkey. If the reading is successful, the screen will prompt "File Read Successful".

**Description:** The file size is displayed on the right side of the file. If 0B is displayed, the file is empty.

- To recall the waveform file in the USB storage device, turn the knob to select **USBDEVICE** in the memory selection interface. Press the **Arb file** softkey and the instrument will list the directories of the folders and files in the USB storage device. Turn the knob to select a folder or file. Select the file with the suffix of bin and press the **CallOut** softkey. If the reading is successful, the screen will prompt "File Read Successful".

To copy the waveform file from the USB storage device to internal memory:

- After the waveform file in the USB storage device is called up according to the previous step, press the **Back** softkey to return to the upper directory. After returning to the memory selection interface, turn the knob to select **INTER** and press the **Arb file** softkey. Turn the knob to select a USER file and press the **Save** softkey to copy the waveform file to the internal memory.

**Description:** In the arbitrary waveform interface, Shape displays the storage location or waveform name of the current arbitrary waveform. USER indicates the internal memory, External indicates the USB storage device, and if it is a built-in waveform, the built-in waveform name is displayed.

### Erase waveforms from memory

To erase all waveforms from the instrument internal memory:

- (1) Press the front panel **Store** function key to enter the file system.
- (2) Select **INTER** under the memory selection interface, and then press the **Arb file** softkey.
- (3) Press the **Secure** softkey, the screen pops up, and then press the **OK** softkey to erase all waveforms stored in internal memory.

## Save/recall Instrument Settings

The instrument settings can be saved as files in internal memory. Up to 16 instrument settings can be saved in the instrument internal memory. The saved settings can be restored from files in the internal memory.

### Operation Step:

Press the front panel **Store** function key to enter the file system.

- If you want to save the settings to the internal memory, select **INTER** and press the **Set File** softkey. Turn the knob to select a Setup file and press the **Save** softkey. (The file size is displayed on the right side of the Setup file. If 0B is displayed, it means the file is empty.)
- Note: Press the **Secure** softkey, and then press the **OK** softkey to clear all the settings in the internal memory.
- To recall a setup, select the desired setup, and press the **CallOut** softkey.

## Preset Settings (Preset)

Sets the reset setting or power-on setting of the generator.

## Restore to the factory setting

- (1) Press the front panel **Preset** function key to enter the preset menu.
- (2) Press the **ResetSet** softkey to select **Factory**.
- (3) Press the **Reset** softkey, and then press the **OK** softkey to restore the generator to the factory default settings.

**Table 5-1: The factory default settings**

Output Configuration	Factory Setting
CH1 signal output switch	Off
CH2 signal output switch	Off
Function	Sine
Frequency	1 kHz



## 5. Panel Operation

Amplitude/Offset	1 Vpp / 0 Vdc
<b>Basic Waveform</b>	<b>Factory Setting</b>
Frequency	1 kHz
Period	1 ms
Amplitude	1 Vpp
Offset	0 V
High Level	500 mV
Low Level	-500 mV
Start Phase	0°
Ramp Wave Symmetry	50%
Pulse Width	200 us
Pulse Duty Cycle	20%
Pulse Rising Time	1.953125 us
Pulse Falling Time	1.953125 us
Build-in Wave	X <sup>2</sup>
Harmonic Wave Type	Even
Harmonic Wave Order	2
Harmonic Wave SN	2
Harmonic Wave Amplitude	1 Vpp
Harmonic Wave Phase	0°
<b>Modulation Waveform</b>	<b>Factory Setting</b>
Modulation type	AM
<b>AM</b>	
Modulating Waveform	Sine
AM Frequency	100 Hz
Modulation Depth	100%
Modulation Source	Internal
<b>FM</b>	
Modulating Waveform	Sine
FM Frequency	100 Hz
Frequency Deviation	100 Hz
Modulation Source	Internal
<b>PM</b>	
Modulating Waveform	Sine

## 5. Panel Operation

PM Frequency	100 Hz
Phase Deviation	0°
Modulation Source	Internal
<b>PWM</b>	
Modulating Waveform	Sine
PWM Frequency	100 Hz
Duty Cycle Deviation	0%
Modulation Source	Internal
<b>ASK</b>	
ASK Rate	100 Hz
Modulating Amplitude	1 Vpp
Modulation Source	Internal
<b>PSK</b>	
PSK Rate	100 Hz
PSK Phase Deviation	0°
Modulation Source	Internal
<b>FSK</b>	
FSK Rate	100 Hz
Hop Frequency	100 Hz
Modulation Source	Internal
<b>3FSK</b>	
FSK Rate	100 Hz
Hop Frequency 1	100 Hz
Hop Frequency 2	100 Hz
<b>4FSK</b>	
FSK Rate	100 Hz
Hop Frequency 1	100 Hz
Hop Frequency 2	100 Hz
Hop Frequency 3	100 Hz
<b>BPSK</b>	
Bit Rate	100 Hz
BPSK Phase Deviation	180°
Data Source	PN15
<b>QPSK</b>	

## 5. Panel Operation

Rate	100 Hz
<b>OSK</b>	
OSK Rate	1 kHz
Oscillate Time	100 us
<b>Sweep</b>	<b>Factory Setting</b>
Sweep Time	1 s
Sweep Type	Linear
Start Frequency	100. Hz
Stop Frequency	1 kHz
Center Frequency	550 Hz
Frequency Span	900 Hz
Trigger Source	Internal
Slope	Positive
<b>Burst</b>	<b>Factory Setting</b>
Burst Period	1 s
Burst Mode	N_Cycle
Number of Cycles	1
Trigger Source	Internal
Slope	Positive
Gated Polarity	Positive
<b>Counter</b>	<b>Factory Setting</b>
Coupling	AC
Sensitivity	Low
High Frequency Reject	On
Trigger Level	0 V
<b>Edit</b>	<b>Factory Setting</b>
Number of Waveform Points	1000
Interpolation	Off
Basic Template	Blank
<b>Save/recall instrument settings</b>	<b>Factory Setting</b>
Reset Settings	Factory
Power On Setting	Last time setting
User Settings	Setup0

Utility	Factory Setting
Backlight	100%
Screen Saver	On
Screen Saver Time	30 Minute
Thousand Separator	Space
CH1 synchronization	Off
CH2 synchronization	Off
CH1 load	50 ohm
CH2 load	50 ohm
USB device	USB TMC
IP Address	192.168.1.99
Gateway	192.168.1.1
Subnet mask	255.255.255.000
Port	3000
Language	Factory Delivery Setting
Beeper	On
Clock Ref	Internal
Between Channels	Factory Setting
Frequency Sync	Off
Amplitude Sync	Off

### Restore to the user setting

- (1) To save the current system setting as a user-defined setting, refer to *Save/recall Instrument Settings* on page 58.
- (2) Press the front panel **Preset** function key to enter the preset menu.
- (3) Press the **ResetSet** softkey to select **User**.
- (4) Press the **User** softkey to select the desired user setup file (**Setup0** to **Setup15**).  
Note: Before selecting any of **Setup0** to **Setup15**, make sure that valid setting file is stored in the corresponding storage location.
- (5) Press the **Reset** softkey, and press the **OK** softkey to restore the generator to the selected user-defined setting.

## Power-on setting

Set the settings to be used when the instrument is powered on the next time to a specified setting.

- (1) Press the front panel **Preset** function key to enter the preset menu.
- (2) Press the **PowerOn** softkey to select power-on settings as **Last**, **User** or **Factory**.

### **Last**

When powered, restore the generator to the setting at last shutdown.

### **User**

When powered, restore the generator to a user-defined setting.

To save the current system setting as a user-defined setting, refer to *Save/recall Instrument Settings* on page 58.

Press the **User** softkey to select the desired user setup file (**Setup0** to **Setup15**).

Note: Before selecting any of **Setup0** to **Setup15**, make sure that valid setting file is stored in the corresponding storage location.

### **Factory**

When powered, restore the generator to factory default settings. The factory default settings are in *Table 5-1*.

## Use Build-in Help (Help)

- (1) To get help about any front panel button or menu softkey, first press the front panel **Help** function button, then press the button you need help with.
- (2) Press the **Help** function button again to exit the help interface.

## 6. Communicate with PC

Supports communication with a computer via a USB port or a LAN port. Using the Waveform Editor software installed on the computer, the signal generator can be operated on the computer to control the output of the signal generator.

Here's how to connect to a computer. First, install the Waveform Editor software on the CD-ROM on your computer. Then, there are several connection options to choose from.

### Using USB Port

- (1) **Set the USB device protocol type of the signal generator:** Press **Utility** → **I/O Setup** → **USBDEV**, switch to PC.
- (2) **Connection:** Connect the **USB Device** interface at the rear panel of the signal generator to the USB interface of the computer with a USB cable.
- (3) **Install the driver:** Run Waveform Editor software on the computer, press F1 to view the built-in help documentation. Follow the instructions to install the driver. The path of the driver is the USBDRV folder in the directory where the Waveform Editor communication software is located, such as "C:\Program Files (x86)\DS\_Wave\Waveform Editor\USBDRV".
- (4) **Host computer communication port setting:** Open the Waveform Editor software, click "**Communications**" in the menu bar, select "**Ports-Settings**", in the setting dialog box, select the communication port as "**USB**". After the connection is successful, the connection status prompt in the lower right corner of the software interface turns green.

### Using LAN Port

#### Connect Directly

- (1) **Connection.** Plug one end of the network cable into the LAN connector on the rear panel of the signal generator; the other end is plugged into the LAN interface of the computer.
- (2) **Set the network parameters of the computer.** Since the signal generator does not support automatic IP address acquisition, you need to specify the IP yourself. Here we set the IP address to 192.168.1.71.
- (3) **Set the network parameters of the host computer.** Run Waveform Editor software on the computer. In the "Communications" menu, under "Ports-Settings", select the communication port as "LAN", the IP is set to be the same as the first three fields of the computer's network IP in step (2), and the

last field has a different IP address. It is "192.168.1.99"; the port can be set to any value from 0 to 4000. However, since ports below 2000 are often occupied, it is recommended to set it to 2000 or higher. Here, it is set to "3000".

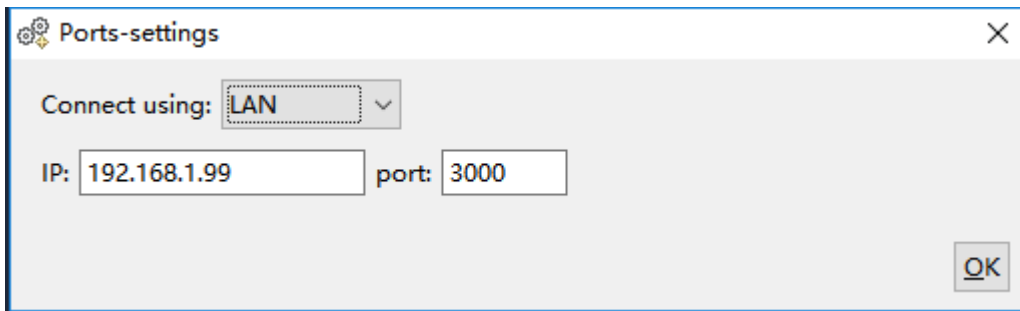
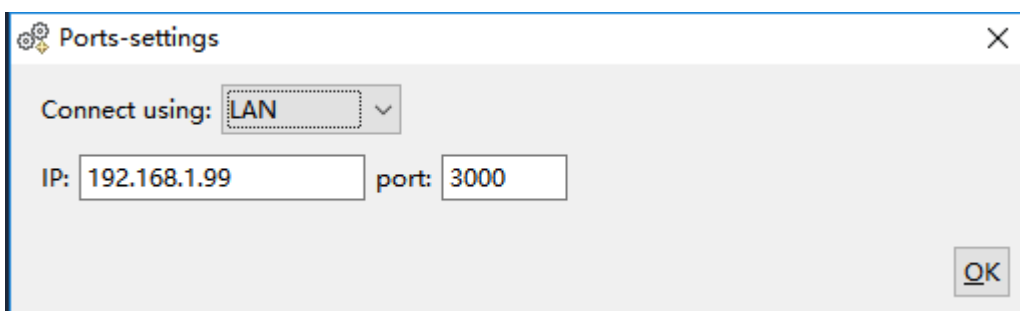

**Figure 5-1: Setting the network parameters of the host computer**

- (4) **Set the network parameters of the signal generator.** In the signal generator, press **Utility** → **I/O Setup** → **Network setting** to enter the submenu. Set the IP address and port to the IP and port in the PC software port settings in step (3). After the shutdown and restart, if the data can be obtained normally in the PC software, the connection is successful.

## Connect through a Router

- (1) **Connection.** Connect the LAN interface on the rear panel of the signal generator to the router with a network cable. The computer is also connected to the router.
- (2) **Set the network parameters of the computer.** Since the signal generator does not support automatic IP address acquisition, you need to specify the IP yourself. The default gateway and subnet mask settings must match the settings of the router. For example, the IP address is set to 192.168.1.71, the subnet mask is set to 255.255.255.0, and the default gateway is set to 192.168.1.1.
- (3) **Set the network parameters of the host computer.** Run Waveform Editor software on the computer. In the "Communications" menu, under "Ports-Settings", select the communication port as "LAN", the IP is set to be the same as the first three fields of the computer's network IP in step (2), and the last field has a different IP address. It is "192.168.1.99"; the port can be set to any value from 0 to 4000. However, since ports below 2000 are often occupied, it is recommended to set it to 2000 or higher. Here, it is set to "3000".



**Figure 6-1: Set the network parameters of the host computer**

- (4) Set the network parameters of the signal generator.** In the signal generator, press **Utility** → **I/O Setup** → **Network setting** to enter the submenu. Set the IP address and port to the IP and port in the PC software port settings in step (3). The gateway settings need to be the same as the gateway settings of the router. After the shutdown and restart, if the data can be obtained normally in the PC software, the connection is successful.

For the specific operation method of Waveform Editor software, please press F1 to view the built-in help documentation.



## 7. Troubleshooting

**1. The screen is still black and there is no display after you press the power switch, please follow the steps below:**

- Check whether the power is connected correctly.
- Check whether the fuse below the power connector meets the specified type and rating and in good condition (the cover can be pried open with a flat-blade screwdriver).
- Restart the instrument after completing the above inspections.
- If the problem still exists, please contact **OWON** for our service.

**2. The measured value of the output signal amplitude does not match the displayed value:**

Check whether the actual load value of the signal is consistent with the load value set in the instrument. Please refer to *Load* on page 52.

If you encounter other problems, please try to reset the settings (see *Restore to the factory setting* on page 58) or restart the instrument. If it still can not work properly, please contact **OWON** for our service.

## 8. Specification

All technical specifications are guaranteed when the following conditions are met, unless otherwise stated.

- The signal generator must be operated continuously for more than 30 minutes at the specified operating temperature (20°C to 30°C) to meet these specifications;
- The signal generator is in the calibration interval and has performed a self-calibration.

In addition to the specifications marked with the word "Typical", the specifications used are guaranteed.

### Waveforms

Waveforms		
Bandwidth	XDG2100	100 MHz
	XDG2080	80 MHz
	XDG2060	60 MHz
	XDG2035	35 MHz
Sample Rate	500MSa/s	
Vertical Resolution	14 bits	
Channel	2	
Standard Waveforms	Sine wave, square wave, ramp wave, pulse wave, noise, harmonic	
Arbitrary Waveforms	Sinc, exponential rise, exponential decline, electrocardiogram, Gaussian, semi-positive, Lorentz, dual audio, DC voltage totaling more than 150 kinds	

### Frequency Characteristics

Frequency Characteristics (Frequency resolution to 1 $\mu$ Hz)		
Sine wave	XDG2100	1 $\mu$ Hz - 100 MHz
	XDG2080	1 $\mu$ Hz - 80 MHz
	XDG2060	1 $\mu$ Hz - 60 MHz
	XDG2035	1 $\mu$ Hz - 35 MHz
Square wave	XDG2100	1 $\mu$ Hz - 30 MHz
	XDG2080	1 $\mu$ Hz - 30 MHz
	XDG2060	1 $\mu$ Hz - 30 MHz
	XDG2035	1 $\mu$ Hz - 15 MHz
Pulse wave	XDG2100	1 $\mu$ Hz - 25 MHz
	XDG2080	1 $\mu$ Hz - 25 MHz
	XDG2060	1 $\mu$ Hz - 25 MHz
	XDG2035	1 $\mu$ Hz - 15 MHz

## 8.Specification

Ramp wave	1 μHz - 3 MHz	
Noise wave (-3 dB)	XDG2100	100 MHz BW
	XDG2080	80 MHz BW
	XDG2060	60 MHz BW
	XDG2035	35 MHz BW
Arbitrary wave	1 μHz - 15 MHz	
Harmonic wave	XDG2100	1 μHz - 50 MHz
	XDG2080	1 μHz - 40 MHz
	XDG2060	1 μHz - 30 MHz
	XDG2035	1 μHz - 17.5MHz
Frequency resolution	1 μHz or 10 significant figures	
Frequency stability	±2 ppm at 25±5°C	
Frequency aging rate	±1 ppm per year	

### Amplitude Characteristics

Amplitude Characteristics (not specifically labeled, the load defaults to 50Ω)	
Output amplitude (load defaults to 50Ω)	1mVpp to 10Vpp (≤ 25MHz) 1mVpp to 5Vpp (≤ 60MHz) 1mVpp to 2.5Vpp (≤ 100MHz)
Bandwidth flatness (relative to 100 kHz Sine wave, 1 Vpp, 50Ω)	≤10MHz: ±0.2dB ≤60MHz: ±0.3dB ≤100MHz: ±0.5dB
Amplitude accuracy	± (1% of setting + 1 mVpp) (1kHz sine, 0V offset, >10mVpp)
Amplitude resolution	0.1mVpp or 4 digits (The amplitude ≥ 1Vpp is 1mVpp)
DC offset range (High resistance)	± (10 Vpk – Amplitude Vpp / 2)
DC offset accuracy	± (1 % of  setting  + 1 mV + amplitude Vpp * 0.5%)
Offset resolution	0.1 mVpp or 4 digits (The amplitude > 1 Vpp is 1 mVpp)
Units	mVpp, Vpp, Vrms, mVrms, dBm
Output Impedance	50Ω (Typical)
Output protection	Short circuit protection, the output will be automatically turned off when overloaded

### Signal Characteristics

Signal Characteristics	
Sine	
Harmonic distortion	Typical (0dBm) DC to 1MHz: <-65dBc 1MHz to 10MHz: <-60dBc 10MHz to 60MHz: <-55dBc 60MHz to 100MHz: <-50dBc
Total harmonic distortion	< 0.05 %, 10 Hz to 20 kHz, 1 Vpp

## 8.Specification

Non-harmonic distortion	Typical (0dBm) $\leq 10\text{MHz}$ : $< -70\text{dBc}$ $> 10\text{MHz}$ : $< -70\text{dBc} + 6\text{dB/ sound interval}$	
Phase noise	Typical (0dBm, 10kHz offset) $10\text{MHz}$ : $\leq -110\text{dBc/Hz}$	
<b>Square</b>		
Rise/fall time	$< 8\text{ns}$	
Jitter (rms), typical (1Vpp, 50 $\Omega$ )	$\leq 5\text{MHz}$ : $2\text{ppm} + 300\text{ps}$ $> 5\text{MHz}$ : $300\text{ps}$	
Overshoot	Typical (100 kHz, 1 Vpp) $< 3\%$	
Duty cycle	50.00% (fixed)	
<b>Ramp</b>		
Linearity	$< 0.1\%$ of peak output (typical 1 kHz, 1 Vpp, symmetry 50%)	
Symmetry	0.0% to 100.0%	
<b>Pulse</b>		
Period	XDG2100 XDG2080 XDG2060	40 ns to 1000 ks
	XDG2035	66.667 ns to 1000 ks
Pulse Width	XDG2100 XDG2080 XDG2060	$\geq 12\text{ns}$
	XDG2035	$\geq 18\text{ns}$
Duty cycle	0.1% to 99.9% (limited by the frequency setting)	
Rise and fall time	$\geq 8\text{ns}$ (limited by the pulse width setting)	
Overshoot	$< 3\%$	
Jitter (rms), typical (1Vpp, 50 $\Omega$ )	$\leq 5\text{MHz}$ : $2\text{ppm} + 300\text{ps}$ $> 5\text{MHz}$ : $300\text{ps}$	
<b>Noise</b>		
Types	Gaussian white noise	
Bandwidth (-3dB)	XDG2100	100 MHz BW
	XDG2080	80 MHz BW
	XDG2060	60 MHz BW
	XDG2035	35 MHz BW
<b>Arbitrary wave</b>		
Waveform length	2 to 10M points	
Sampling rate	500M Sa/s	
Amplitude accuracy	14 bits	
Minimum rise and fall time	$< 8\text{ns}$	
Jitter (rms), typical (1Vpp, 50 $\Omega$ )	$\leq 5\text{MHz}$ : $2\text{ppm} + 300\text{ps}$ $> 5\text{MHz}$ : $300\text{ps}$	
<b>Harmonic wave</b>		
Harmonic number	$\leq 16$	
Harmonic type	Odd, even, sequential, custom	

## 8.Specification

Harmonic amplitude	Each harmonic amplitude can be set
Harmonic phase	Each harmonic phase can be set

### Modulation Characteristics

Modulation Characteristics	
Modulation Type	AM, DSB-AM, FM, PM, ASK, FSK, PSK, BPSK, QPSK, 3FSK, 4FSK, OSK, PWM, SUM
<b>AM</b>	
Carrier	Sine wave, square wave, ramp wave, arbitrary wave (except DC)
Modulated signal source	Internal or external
Internal modulation waveform	Sine wave, square wave, ramp wave, white noise, arbitrary waveform
Internal amplitude modulation frequency	2 MHz to 1 MHz
Depth	0% to 120%
<b>DSB-AM</b>	
Carrier	Sine wave, square wave, ramp wave
Modulated signal source	Internal or external
Internal modulation waveform	Sine wave, square wave, ramp wave
Internal amplitude modulation frequency	2 MHz to 1 MHz
Depth	0% to 100%
<b>FM</b>	
Carrier	Sine wave, square wave, ramp wave, arbitrary wave (except DC)
Modulated signal source	Internal or external
Internal modulation waveform	Sine, square, ramp, white noise, and arbitrary waveforms
Internal modulation frequency	2 MHz to 1 MHz
Frequency offset	$2 \text{ MHz} \leq \text{offset} \leq \min(\text{carrier frequency}, \text{carrier maximum frequency} - \text{carrier frequency})$ by default, the smaller of the two
<b>PM</b>	
Carrier	Sine wave, square wave, ramp wave, arbitrary wave (except DC)
Modulated signal source	Internal or external
Internal modulation waveform	Sine, square, ramp, white noise, and arbitrary waveforms
Internal phase modulation frequency	2 MHz to 1 MHz
Phase deviation range	0° to 180°
<b>PWM</b>	
Carrier	Pulse wave
Modulated signal source	Internal or external

## 8.Specification

Internal modulation waveform	Sine, square, ramp, white noise, and arbitrary waveforms (except DC)
Internal phase modulation frequency	2 MHz to 1 MHz
Offset	0 to min (min is the smaller value of pulse wave duty cycle and 100%-pulse wave duty cycle)
<b>ASK</b>	
Carrier	Sine wave, square wave, ramp wave, arbitrary wave
Modulated signal source	Internal or external
Internal modulation waveform	50% square wave
ASK frequency	2 MHz to 1MHz
<b>PSK</b>	
Carrier	Sine wave, square wave, ramp wave, arbitrary wave
Modulated signal source	Internal or external
Internal modulation waveform	50% square wave
PSK frequency	2 MHz to 1MHz
<b>FSK</b>	
Carrier	Sine wave, square wave, ramp wave, arbitrary wave
Modulated signal source	Internal or external
Internal modulation waveform	50% square wave
FSK frequency	2 MHz to 1MHz
<b>3FSK</b>	
Carrier	Sine wave, square wave, ramp wave, arbitrary wave
Modulated signal source	Internal
Internal modulation waveform	50% square wave
FSK frequency	2 MHz to 1MHz
<b>4FSK</b>	
Carrier	Sine wave, square wave, ramp wave, arbitrary wave
Modulated signal source	Internal
Internal modulation waveform	50% square wave
FSK frequency	2 MHz to 1MHz
<b>BPSK</b>	
Carrier	Sine wave, square wave, ramp wave, arbitrary wave
Modulated signal source	Internal
Internal modulation waveform	50% square wave
BPSK frequency	2 MHz to 1MHz
<b>QPSK</b>	

## 8.Specification

Carrier	Sine wave, square wave, ramp wave, arbitrary wave
Modulated signal source	Internal
Internal modulation waveform	50% square wave
QPSK frequency	2 MHz to 1MHz
<b>OSK</b>	
Carrier	Sine wave
Modulated signal source	Internal
Internal modulation waveform	50% square wave
Oscillation time	8ns to 249.75 $\mu$ s
OSK frequency	2 MHz to 1MHz
<b>SUM</b>	
Carrier	Sine wave, square wave, ramp wave
Modulated signal source	Internal or external
Internal modulation waveform	Sine wave, square wave, ramp wave, white noise, arbitrary waveform
Internal amplitude modulation frequency	2 MHz to 1 MHz
Depth	0.0% to 100.0%

### Sweep Characteristics

Sweep Characteristics			
Carrier	Sine, rectangular wave, ramp wave, arbitrary wave (Except DC)		
Minimum/maximum starting frequency	1 $\mu$ Hz		
Maximum/Stop frequency	Sine wave	XDG2100	100MHz
		XDG2080	80MHz
		XDG2060	60MHz
		XDG2035	35MHz
	Square wave	XDG2100 XDG2080 XDG2060	30MHz
		XDG2035	15MHz
Ramp wave	3MHz		
Arbitrary wave	15MHz (built-in waveform) or 25MHz (user-defined waveform)		
Types	Linear, logarithmic, Step		
Sweep direction	Up / Down		
Sweep time	1 ms to 500 s $\pm$ 0.1%		
Trigger source	Internal, external, manual		

## Burst Characteristics

Burst Characteristics	
Waveform	Sine wave, square wave, ramp wave, pulse wave, Noise wave (Except N Cycle) and arbitrary wave (Except DC)
Types	Count (1 to 100,000 cycles), unlimited, gated
Trigger source	Internal, external, manual
Carrier frequency	2mHz to BW/ 2
Trigger cycle	20ns - 500 s (Min = Cycles * Period)
Gated source	External trigger

## Counter Specifications

Counter Specifications	
Measurement function	Frequency, period, positive pulse width, negative pulse width, duty cycle
Frequency Range	100 mHz - 200 MHz
Frequency resolution	7 digits
Coupling method	AC, DC
<b>Voltage range and sensitivity (non-modulated signal)</b>	
DC offset range	±1.5V
DC coupling	100mHz - 100 MHz: 250 mVpp - 5 Vpp (AC+DC) 100 Hz - 200 MHz: 400 mVpp - 5 Vpp (AC+DC)
AC coupling	1Hz - 100 MHz: 250 mVpp - 5 Vpp 100 Hz - 200 MHz: 400 mVpp - 5 Vpp
Pulse width and duty cycle measurement	1 Hz - 10 MHz (250 mVpp - 5 Vpp)
Input resistance	1 MΩ
Sensitivity	Can be set high, medium and low
Trigger level range	±2.5 V

## Input/Output Characteristics

Input/Output Characteristics	
Communication Interface	USB Host, USB Device, LAN, COM (Optional)
Channel coupling	Channel copy, amplitude syn, frequency syn, align phase
<b>External modulation input</b>	
Input frequency range	DC - 100 kHz
Input level range	± 1V full scale
Input impedance	10 kΩ (typical)
<b>External trigger input</b>	
Level	TTL-compatible
Slope	Rising or falling (selectable)
Pulse Width	>100ns



## 8.Specification

<b>External clock input</b>	
Impedance	1M $\Omega$ , AC coupling
Input level range	1Vpp to 3.3Vpp
Lock time	<1s
Lock range	10 MHz $\pm$ 50Hz
<b>Internal clock output</b>	
Frequency	10 MHz $\pm$ 50Hz
Impedance	50 $\Omega$ , DC coupling
Amplitude	1.2Vpp (50 $\Omega$ )
<b>Sync Output</b>	
Level	3.3V LVTTTL
Impedance	50 $\Omega$ , DC coupling
Maximum frequency	1MHz

### General Specifications

<b>Display</b>	
Display type	7-inch color LCD display
Display resolution	800 Horizontal $\times$ 480 Vertical pixels
Display color	65536 colors, 16 bits, TFT
Touch screen (Optional)	capacitive, multi-touch
<b>Power</b>	
Voltage	100 - 240 V ( $\pm$ 10%), 50 / 60 Hz
Power consumption	Less than 50VA
Fuse	250V, F2AL
<b>Environment</b>	
Temperature	Working temperature: 0 $^{\circ}$ C to 40 $^{\circ}$ C
	Storage temperature: -20 $^{\circ}$ C to 60 $^{\circ}$ C
Relative humidity	Less than 35 $^{\circ}$ C: $\leq$ 90% relative humidity 35 $^{\circ}$ C to 40 $^{\circ}$ C: $\leq$ 60% relative humidity
Height	Operating 3,000 meters Non-operation 12,000 meters
Cooling method	Smart fan cooling
<b>Mechanical Specification</b>	
Dimension	340 mm (Length) $\times$ 177 mm (Height) $\times$ 90mm (Width)
Weight	Approx. 2.3 kg
<b>Others</b>	
IP protection	IP2X
Adjustment interval	The recommended calibration interval is one year

## 9. Appendix

### Appendix A: Accessories

- 1 × power cord that meets the standards of the country where you are located
- 1 × USB communication cable
- 1 × CD with communication software
- 1 × Quick Guide
- 2 × BNC/Q9 cable

### Appendix B: General Care and Cleaning

#### General Maintenance

Do not store or leave the instrument where the liquid crystal display will be exposed to direct sunlight for long periods of time.

**Caution:** To avoid any damage to the instrument or probe, do not exposed it to any sprays, liquids, or solvents.

#### Cleaning

Inspect the instrument and probes as often as operating conditions require. To clean the instrument exterior, perform the following steps:

1. Wipe the dust from the instrument and probe surface with a soft cloth. Do not make any scuffing on the transparent LCD protection screen when clean the LCD screen.
2. Disconnect power before cleaning your instrument. Clean the instrument with a wet soft cloth not dripping water. It is recommended to scrub with soft detergent or fresh water. To avoid damage to the instrument or probe, do not use any corrosive chemical cleaning agent.

---

 **Warning:** Before power on again for operation, it is required to confirm that the instrument has already been dried completely, avoiding any electrical short circuit or bodily injury resulting from the moisture.

---