



**TAO3000 Dual-Channel Series
Tablet Oscilloscopes
User Manual**

May 2020 edition V1.0.0

Copyright © LILLIPUT Company. All rights reserved.

The LILLIPUT's products are under the protection of the patent rights, including ones which have already obtained the patent rights and those which are applied for. The information in this manual will replace all materials published.

The information in this manual was correct at the time of printing. However, LILLIPUT will continue to improve products and reserves the rights to change specification at any time without notice.

owon[®] is the registered trademark of the LILLIPUT Company.

General Warranty

OWON warrants that the product will be free from defects in materials and workmanship for a period of 3 years from the date of purchase of the product by the original purchaser from the OWON Company. The warranty period for accessories such as probes, adapter is 12 months. This warranty only applies to the original purchaser and is not transferable to a third party.

If the product proves defective during the warranty period, OWON will either repair the defective product without charge for parts and labour, or will provide a replacement in exchange for the defective product. Parts, modules and replacement products used by OWON for warranty work may be new or reconditioned like new. All replaced parts, modules and products become the property of OWON.

In order to obtain service under this warranty, the customer must notify OWON of the defect before the expiration of the warranty period. Customer shall be responsible for packaging and shipping the defective product to OWON's designated service centre, a copy of the customers proof of purchase is also required.

This warranty shall not apply to any defect, failure or damage caused by improper use or improper or inadequate maintenance and care. OWON shall not be obligated to furnish service under this warranty a) to repair damage resulting from attempts by personnel other than OWON representatives to install, repair or service the product; b) to repair damage resulting from improper use or connection to incompatible equipment; c) to repair any damage or malfunction caused by the use of non-OWON supplies; or d) to service a product that has been modified or integrated with other products when the effect of such modification or integration increases the time or difficulty of servicing the product.

Please contact the nearest OWON's Sales and Service Offices for services.

For better after-sales service, please visit www.owon.com and register the purchased product online.

Excepting the after-sales services provided in this summary or the applicable warranty statements, OWON will not offer any guarantee for maintenance definitely declared or hinted, including but not limited to the implied guarantee for marketability and special-purpose acceptability. OWON should not take any responsibilities for any indirect, special or consequent damages.

Table of Contents

1. <i>General Safety Requirements</i>	1
2. <i>Safety Terms and Symbols</i>	2
3. <i>Junior User Guidebook</i>	4
Introduction to the Structure of the Oscilloscope	5
Front Panel	5
Side Panel.....	6
Top Panel.....	7
User Interface Introduction	7
How to Implement the General Inspection.....	9
How to Implement the Function Inspection.....	10
How to Implement the Probe Compensation	11
How to Set the Probe Attenuation Coefficient.....	11
How to Use the Probe Safely	12
How to Implement Self-calibration	13
Introduction to the Vertical System	13
Introduction to the Horizontal System.....	14
Introduction to the Trigger System.....	15
Touchscreen Controls	16
4. <i>Advanced User Guidebook</i>	22
How to Set the Vertical System	23
How to Set the Horizontal System.....	25
Waveform Horizontal Zooming	26
Magnifier (For specific models)	26
How to Operate the Function Menu.....	28
Set the Trigger/Decoding System.....	28
Single Trigger	29
Logic Trigger.....	37
Bus Trigger.....	38
Bus Decoding (Optional).....	44
Implement Sampling Setup.....	48
Implement the Auxiliary System Function Setting	50
Set the Display System.....	53
Save and Recall a Waveform	55
Record/Playback Waveforms	62
Clone and Recall a waveform.....	66
Update your Instrument Firmware	69
Measure Automatically	71
Customize an Automatic Measurement.....	75
Measure with Cursors	76

Use Mathematical Manipulation Function	79
Waveform math	80
User defined function.....	81
Digital Filter	81
Use Autoscale function	82
Use HOR function	83
Use FFT function	83
Use XY Format	90
Use Pass/Fail function	91
Use Executive Buttons.....	92
Print the Screen Image	94
5. Use the Multimeter	95
Input Terminals	95
DMM Menu	95
DMM Information Window	96
Making Multimeter Measurements.....	97
Measuring AC or DC Current.....	97
Measuring AC or DC Voltage	97
Measuring Resistance	97
Testing Diodes	97
Testing for Continuity.....	98
Measuring Capacitance	98
Multimeter Features	98
Data Hold Mode	98
Making Relative Measurements	98
Information Display	99
Auto or Manual Range.....	99
Multimeter Recorder.....	99
6. Communication with PC.....	102
Using USB Port.....	102
Using LAN Port	103
Connect directly	103
Connect through a router.....	104
Using Wi-Fi to Connect with PC	106
Connect with PC as Wi-Fi Access Point.....	106
Connect with PC as Wi-Fi Station.....	108
7. Communication with Android Device via Wi-Fi (Optional)	110
How to Connect.....	110
Connect with APP as Wi-Fi Access Point.....	110
Connect with APP as Wi-Fi Station	112
User Interface.....	114

Gestures Control	116
8. Demonstration.....	117
Example 1: Measurement a Simple Signal	117
Example 2: Gain of a Amplifier in a Metering Circuit.....	118
Example 3: Capturing a Single Signal	119
Example 4: Analyze the Details of a Signal	121
Example 5: Application of X-Y Function.....	122
Example 6: Video Signal Trigger	124
9. Troubleshooting.....	125
10. Technical Specifications	126
Oscilloscope.....	126
Trigger.....	129
Multimeter	131
General Technical Specifications	131
11. Appendix	133
Appendix A: Enclosure	133
Appendix B: General Care and Cleaning.....	133
Appendix C: Battery Using Guide	134

1. General Safety Requirements

Before use, please read the following safety precautions to avoid any possible bodily injury and to prevent this product or any other connected products from damage. In order to avoid any contingent danger, ensure this product is only used within the range specified.

Only the qualified technicians can implement the maintenance.

To avoid Fire or Personal Injury:

- **Connect the probe correctly.** The grounding end of the probe corresponds to the grounding phase. Please don't connect the grounding end to the positive phase.
- **Use Proper Power Cord.** Use only the power cord supplied with the product and certified to use in your country.
- **Connect or Disconnect Correctly.** When the probe or test lead is connected to a voltage source, please do not connect and disconnect the probe or test lead at random.
- **Check all Terminal Ratings.** To avoid fire or shock hazard, check all ratings and markers of this product. Refer to the user's manual for more information about ratings before connecting to the instrument.
- **Do not operate without covers.** Do not operate the instrument with covers or panels removed.
- **Avoid exposed circuit.** Do not touch exposed junctions and components when the instrument is powered.
- **Do not operate if in any doubt.** If you suspect damage occurs to the instrument, have it inspected by qualified service personnel before further operations.
- **Use your Oscilloscope in a well-ventilated area.** Make sure the instrument installed with proper ventilation, refer to the user manual for more details.
- **Do not operate in wet conditions.**
- **Do not operate in an explosive atmosphere.**
- **Keep product surfaces clean and dry.**

2. Safety Terms and Symbols

Safety Terms

Terms in this manual. The following terms may appear in this manual:

 **Warning:** Warning indicates the conditions or practices that could result in injury or loss of life.

 **Caution:** Caution indicates the conditions or practices that could result in damage to this product or other property.

Terms on the product. The following terms may appear on this product:

Danger: It indicates an injury or hazard may immediately happen.

Warning: It indicates an injury or hazard may be accessible potentially.

Caution: It indicates a potential damage to the instrument or other property might occur.

Safety Symbols

Symbols on the product. The following symbol may appear on the product:



Hazardous Voltage



Refer to Manual



Protective Earth Terminal



Chassis Ground



Test Ground

To avoid body damage and prevent product and connected equipment damage, carefully read the following safety information before using the test tool. This product can only be used in the specified applications.



Warning:

The two channels of the oscilloscope are not electrically isolated. The channels should adopt a common ground during measuring. To prevent

short circuits, the 2 probe grounds must not be connected to 2 different non-isolated DC levels.

The diagram of the oscilloscope ground wire connection:

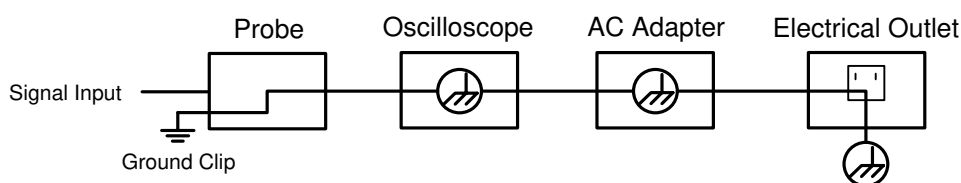

The diagram of the ground wire connection when the battery-powered oscilloscope is connected to the AC-powered PC through the ports:

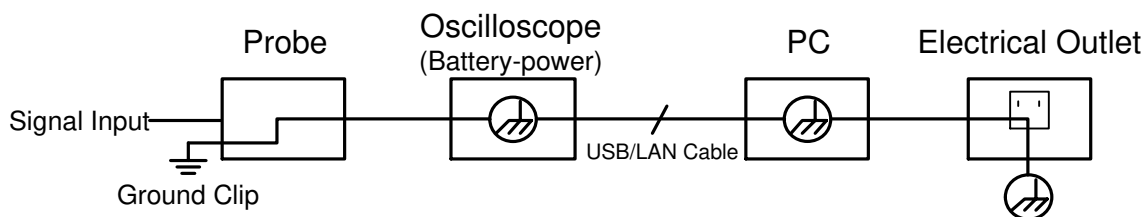

It is not allowed to measure AC power when the oscilloscope is AC powered, or when the battery-powered oscilloscope is connected to the AC-powered PC through the ports.

Warning:

To avoid fire or electrical shock, when the oscilloscope input signal connected is more than 42V peak (30Vrms) or on circuits of more than 4800VA, please take note of below items:

- Only use accessory insulated voltage probes and test lead.
- Check the accessories such as probe before use and replace it if there are any damages.
- Remove probes, test leads and other accessories immediately after use.
- Remove USB cable which connects oscilloscope and computer.
- Do not apply input voltages above the rating of the instrument because the probe tip voltage will directly transmit to the oscilloscope. Use with caution when the probe is set as 1:1.
- Do not use exposed metal BNC or banana plug connectors.
- Do not insert metal objects into connectors.

3. Junior User Guidebook

This chapter deals with the following topics mainly:

- Introduction to the structure of the oscilloscope
- Introduction to the user interface
- How to implement the general inspection
- How to implement the function inspection
- How to make a probe compensation
- How to set the probe attenuation coefficient
- How to use the probe safely
- How to implement a self-calibration
- Introduction to the vertical system
- Introduction to the horizontal system
- Introduction to the trigger system
- Touchscreen controls

Introduction to the Structure of the Oscilloscope

This chapter makes a simple description of the operation and function of the oscilloscope, enabling you to be familiar with the use of the oscilloscope in the shortest time.

Front Panel

The front panel has knobs and function buttons. Through the function buttons, you can enter different function menus or obtain a specific function application directly.

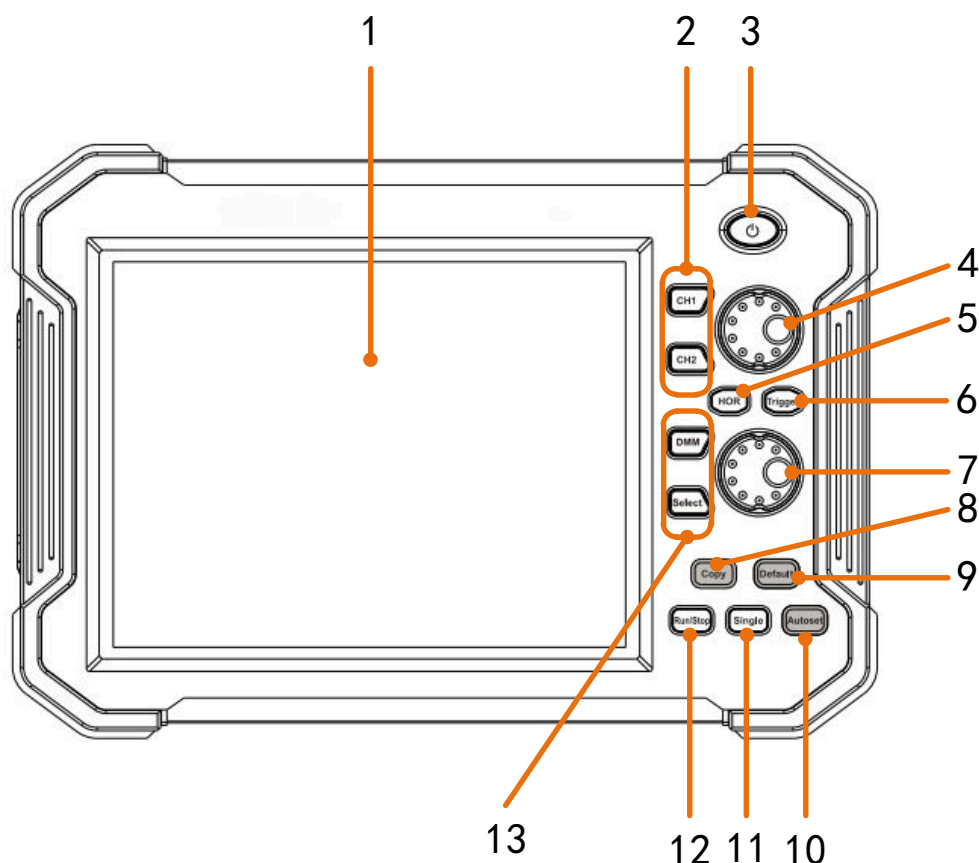



Figure 3-1 Front panel

1. LCD touchscreen
2. **CH1, CH2** buttons: Access to setting menu of CH1, CH2.
3. **Power** button: Power on/off
4. The upper knob:
 - When one of the **CH1, CH2** buttons is lighted, this knob is used to adjust the vertical position of current channel,
 - When **HOR** button is lighted, this knob is used to adjust the horizontal positions of all channels (including mathematical operations).
 - When **Trigger** button is lighted, this knob is used to adjust trigger level.
5. **HOR** button: When the button light is off, press to light on, the upper and lower knob are for horizontal system. Press to switch between the normal mode and

the waveform zooming mode.

6. **Trigger** button: Accesses to trigger system setting. When the button light is on, the upper knob is used to adjust trigger level of current channel.
7. The lower knob:
When one of the **CH1**, **CH2** buttons is lighted, this knob is used to adjust the voltage scale of current channel.
When **HOR** button is lighted, this knob is used to adjust time base.
8. **Copy** button: You can save the waveform by just pushing this button in any user interface. The source wave and the storage location are set in the **Save** menu when the Type is **Wave** ( → **Save**).
9. **Default** button: Press this button, a prompt will show, press again to execute the factory settings.
10. **Autoset** button: Quick way to apply a set of pre-set functions to the incoming signal, and display the best possible viewing waveform of the signal.
11. **Single** button: Set the trigger mode as single directly.
12. **Run/Stop** button: Enable or disable sampling on input signals.
13. **DMM** button: Quickly turn on or off the multimeter measurement function.
Select: Switch between AC and DC when measuring voltage or current; and switch resistance, continuity, diode, and capacitance measurement when selecting other.

Side Panel

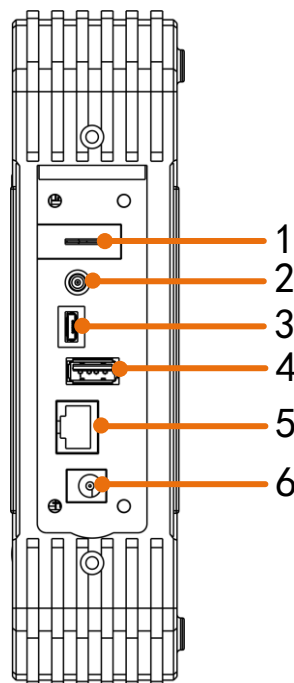



Figure 3-2 Side Panel

1. Probe Compensation: Measurement signal (5V/1kHz) output.
2. **Trig Out or Pass/Fail** output connector: Trigger signal output or Pass/Fail output. The output type can be set on the menu ( → Utility → Function →

Output → Output).

3. **USB Device port:** It is used to transfer data when external USB equipment connects to the oscilloscope regarded as "slave device". For example: to use this port when connect PC to the oscilloscope by USB.
4. **USB Host port:** It is used to transfer data when external USB equipment connects to the oscilloscope regarded as "host device". For example: Saving the waveform to USB flash disk needs to use this port.
5. **LAN port:** the network port which can be used to connect with PC.
6. Connector for the DC power source via an AC-DC adapter

Top Panel

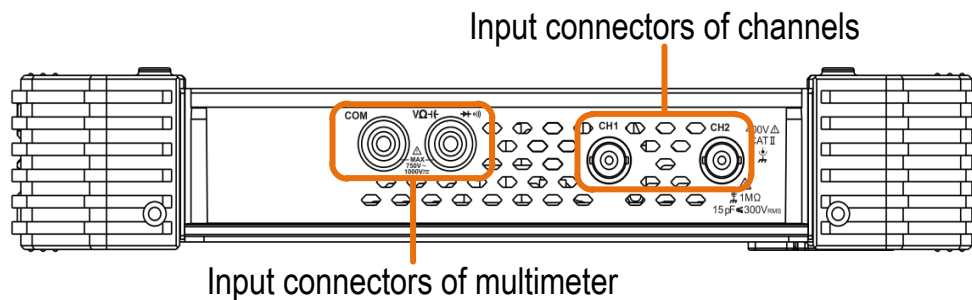

Figure 3-3 Top Panel

User Interface Introduction

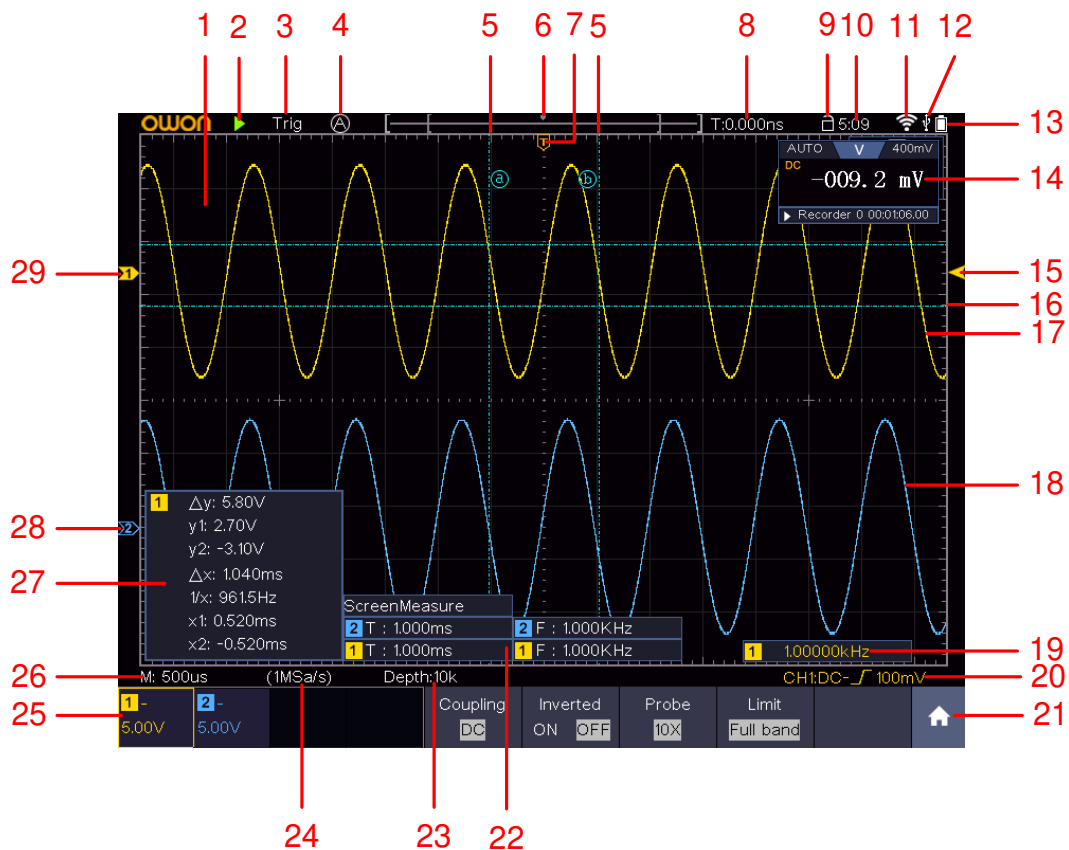





Figure 3-4 Illustrative Drawing of Display Interfaces

1. Waveform Display Area.
2. Run/Stop (touchable) (see "*Use Executive Buttons*" on P95)
3. The state of trigger, including:
 - Auto: Automatic mode and acquire waveform without triggering.
 - Trig: Trigger detected and acquire waveform.
 - Ready: Pre-triggered data captured and ready for a trigger. Click the **Ready** to force a trigger signal, which is mainly applied to the "Normal" and "Single" trigger modes.
 - Scan: Capture and display the waveform continuously.
 - Stop: Data acquisition stopped.
4. Click to auto set.
5. The two blue dotted lines indicates the vertical position of cursor measurement.
6. The pointer indicates the trigger position in the record length.
7. The T pointer indicates the horizontal position for the trigger.
8. It shows present triggering value and displays the site of present window in internal memory.
9. Touchable icon is to enable () or disable () the touchscreen controls.
10. It shows setting time (see "*Config*" on P50).
11. Wi-Fi is activated.
12. It indicates that there is a USB disk connecting with the oscilloscope.
13. Indicating battery power status (see "*Display*" on P51).
14. Multimeter window.
15. The waveform of CH1.
16. The pointer shows the trigger level position of the source in trigger menu.
17. The two blue dotted lines indicate the horizontal position of cursor measurement.
18. The waveform of CH2.
19. The frequency of the trigger signal.
20. The icon shows the selected trigger type, e.g.  represents triggering on the rising edge for an Edge trigger. The reading shows the trigger level value of the corresponding channel.
21. Click to show/hide the touchable menu panel.
22. It indicates the measured type and value of the corresponding channel. "**T**" means period, "**F**" means frequency, "**V**" means the average value, "**Vp**" the peak-peak value, "**Vr**" the root-mean-square value, "**Ma**" the maximum amplitude value, "**Mi**" the minimum amplitude value, "**Vt**" the Voltage value of the waveform's flat top value, "**Vb**" the Voltage value of the waveform's flat base, "**Va**" the amplitude value, "**Os**" the overshoot value, "**Ps**" the Preshoot value, "**RT**" the rise time value, "**FT**" the fall time value, "**PW**" the +width value, "**NW**" the -Width value, "**+D**" the +Duty value, "**-D**" the -Duty

- value, "**WP**" the Screen Duty, "**FRR**" the FRR, "**FRF**" the FRF, "**FFR**" the FFR, "**FFF**" the FFF, "**LRR**" the, "**LRF**" the LRF, "**LFR**" the LFR, "**LFF**" the LFF, "**PD**" the Delay A->B Φ value, "**ND**" the Delay A->B Ψ value, "**TR**" the Cycle RMS, "**CR**" the Cursor RMS, "**RP**" the Phase A->B Φ , "**FP**" the Phase A->B Ψ , "**+PC**" the +Pulse count, "**-PC**" the - Pulse count, "**+E**" the Rise edge count, "**-E**" the Fall edge count, "**AR**" the Area, "**CA**" the Cycle area.
23. The readings show the record length.
 24. The readings show current sample rate.
 25. The readings indicate the corresponding Voltage Division of the channels.
"BW" indicates bandwidth limit.
The icon shows the coupling mode of the channel.
"—" indicates direct current coupling
"~" indicates AC coupling
" \equiv " indicates GND coupling
 26. The reading shows the setting of main time base.
 27. It is cursor measure window, showing the absolute values and the readings of the cursors.
 28. The blue pointer indicates the grounding datum point (zero point position) of the waveform of the CH2 channel.
 29. The yellow pointer indicates the grounding datum point (zero point position) of the waveform of the CH1 channel.

How to Implement the General Inspection

After you get a new oscilloscope, it is recommended that you should make a check on the instrument according to the following steps:

1. Check whether there is any damage caused by transportation.

If it is found that the packaging carton or the foamed plastic protection cushion has suffered serious damage, do not throw it away first till the complete device and its accessories succeed in the electrical and mechanical property tests.

2. Check the Accessories

The supplied accessories have been already described in the "Appendix A: Enclosure" of this Manual. You can check whether there is any loss of accessories with reference to this description. If it is found that there is any accessory lost or damaged, please get in touch with the distributor of OWON responsible for this service or the OWON's local offices.

3. Check the Complete Instrument

If it is found that there is damage to the appearance of the instrument, or the instrument cannot work normally, or fails in the performance test, please get in touch with the OWON's distributor responsible for this business or the

OWON's local offices. If there is damage to the instrument caused by the transportation, please keep the package. With the transportation department or the OWON's distributor responsible for this business informed about it, a repairing or replacement of the instrument will be arranged by the OWON.

How to Implement the Function Inspection

Make a fast function check to verify the normal operation of the instrument, according to the following steps:

1. **Long press the  button on the top right of the instrument.**

The instrument carries out all self-check items and shows the Boot Logo. Push the **Default** button on the front panel. The default attenuation coefficient set value of the probe on the menu is 10X.

2. **Set the Switch in the Oscilloscope Probe as 10X and Connect the Oscilloscope with CH1 Channel.**

Align the slot in the probe with the plug in the CH1 connector BNC, and then tighten the probe with rotating it to the right side.

Connect the probe tip and the ground clamp to the connector of the probe compensator.

3. **Push the Autoset button on the front panel.**

The square wave of 1 kHz frequency and 5V peak-peak value will be displayed in several seconds (see *Figure 3-5*).

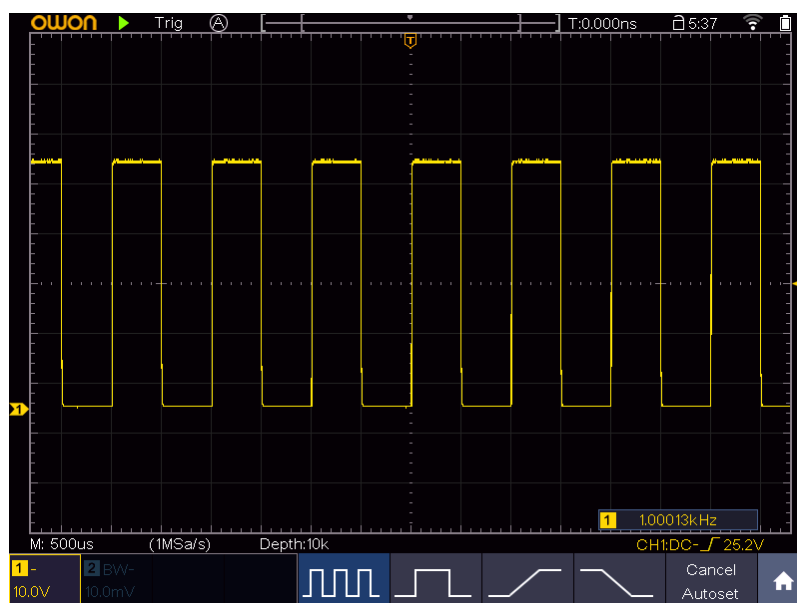

Figure 3-5 Auto set

Check CH2 by repeating Step 2 and Step 3.

How to Implement the Probe Compensation

When connect the probe with any input channel for the first time, make this adjustment to match the probe with the input channel. The probe which is not compensated or presents a compensation deviation will result in the measuring error or mistake. For adjusting the probe compensation, please carry out the following steps:

1. Set the attenuation coefficient of the probe on the menu as 10X and that of the switch in the probe as 10X (see "*How to Set the Probe Attenuation Coefficient*" on P11), and connect the probe with the CH1 channel. If a probe hook tip is used, ensure that it keeps in close touch with the probe. Connect the probe tip with the signal connector of the probe compensator and connect the reference wire clamp with the ground wire connector of the probe connector, and then push the **Autoset** button on the front panel.
2. Check the displayed waveforms and regulate the probe till a correct compensation is achieved (see *Figure 3-6* and *Figure 3-7*).

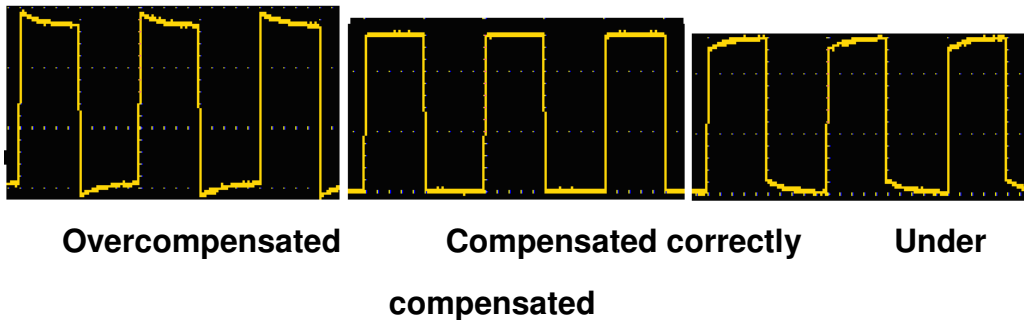

Figure 3-6 Displayed Waveforms of the Probe Compensation

3. Repeat the steps mentioned if needed.

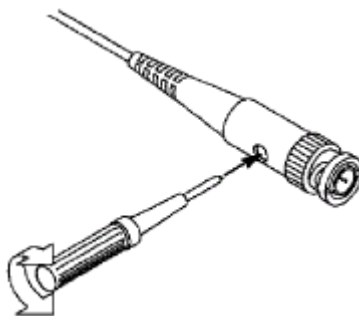

Figure 3-7 Adjust Probe

How to Set the Probe Attenuation Coefficient

The probe has several attenuation coefficients, which will influence the vertical scale factor of the oscilloscope.

To change or check the probe attenuation coefficient on the menu of

oscilloscope:

- (1) Push the function menu button of the used channels (**CH1, CH2** button).
- (2) Select **Probe** in the bottom menu; select **Attenu** in the right menu, select the proper value corresponding to the probe in the left menu.

This setting will be valid all the time before it is changed again.



Caution:

The default attenuation coefficient of the probe on the instrument is preset to 10X.

Make sure that the set value of the attenuation switch in the probe is the same as the menu selection of the probe attenuation coefficient in the oscilloscope.

The set values of the probe switch are 1X and 10X (see *Figure 3-8*).

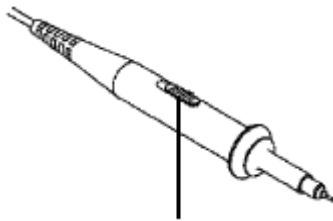

Figure 3-8 Attenuation Switch



Caution:

When the attenuation switch is set to 1X, the probe will limit the bandwidth of the oscilloscope in 5MHz. To use the full bandwidth of the oscilloscope, the switch must be set to 10X.

How to Use the Probe Safely

The safety guard ring around the probe body protects your finger against any electric shock, shown as *Figure 3-9*.

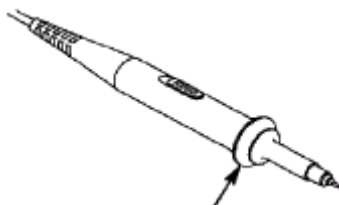

Figure 3-9 Finger Guard

**Warning:**

To avoid electric shock, always keep your finger behind the safety guard ring of the probe during the operation.

To protect you from suffering from the electric shock, do not touch any metal part of the probe tip when it is connected to the power supply.

Before making any measurements, always connect the probe to the instrument and connect the ground terminal to the earth.

How to Implement Self-calibration

The self-calibration application can make the oscilloscope reach the optimum condition rapidly to obtain the most accurate measurement value. You can carry out this application program at any time. This program must be executed whenever the change of ambient temperature is 5°C or over.

Before performing a self-calibration, disconnect all probes or wires from the input connector. Click the  icon, select the **Utility** softkey, select **Function** in the bottom menu, select **Adjust** in the left menu, select **Self Cal** in the bottom menu; run the program after everything is ready.

Introduction to the Vertical System

As shown in *Figure 3-10*, there are a few of buttons and knobs in **Vertical Controls**.

Press one of the channel buttons **CH1** or **CH2** to open the corresponding channel menu, and press again to turn off the channel.

If you want to set the vertical position and vertical scale of a channel, please press CH1 or CH2 at first to select the desired channel. Then turn the upper or lower knob to set the values.

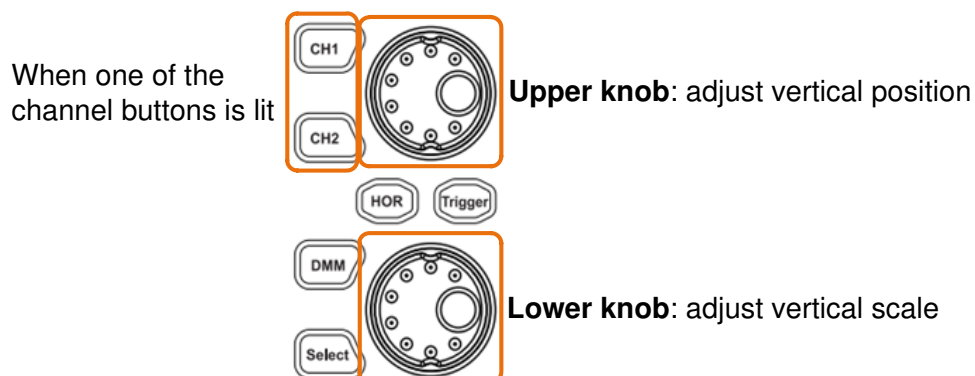

Figure 3-10 Vertical Control

The following practices will gradually direct you to be familiar with the using of the vertical setting.

1. Press **CH1** or **CH2** panel button to select the desired channel.
2. When one of the channel buttons is lit, you can use the upper knob to show the selected channel waveform in the center of the waveform window. The upper knob functions the regulating of the vertical display position of the selected channel waveform. Thus, when the upper knob is rotated, the pointer of the earth datum point of the selected channel is directed to move up and down following the waveform, and the position message at the center of the screen would change accordingly.

Measuring Skill

If the channel is under the DC coupling mode, you can rapidly measure the DC component of the signal through the observation of the difference between the wave form and the signal ground.

If the channel is under the AC mode, the DC component would be filtered out. This mode helps you display the AC component of the signal with a higher sensitivity.

Vertical offset back to 0 shortcut key

Turn the upper knob to change the vertical display position of the selected channel, and push the upper knob to set the vertical display position back to 0 as a shortcut key, this is especially helpful when the trace position is far out of the screen and want it to get back to the screen center immediately.

3. Change the vertical scale setting and observe the consequent state information change.

With the information displayed in the status bar at the bottom of the waveform window, you can determine any changes in the channel vertical scale factor.

Turn the lower knob and change the "Vertical Scale Factor (Voltage Division)" of the selected channel, it can be found that the scale factor of the selected channel in the status bar has been changed accordingly.

Introduction to the Horizontal System

Shown as *Figure 3-11*, there are a button and two knobs in the Horizontal Controls. The following practices will gradually direct you to be familiar with the setting of horizontal time base.

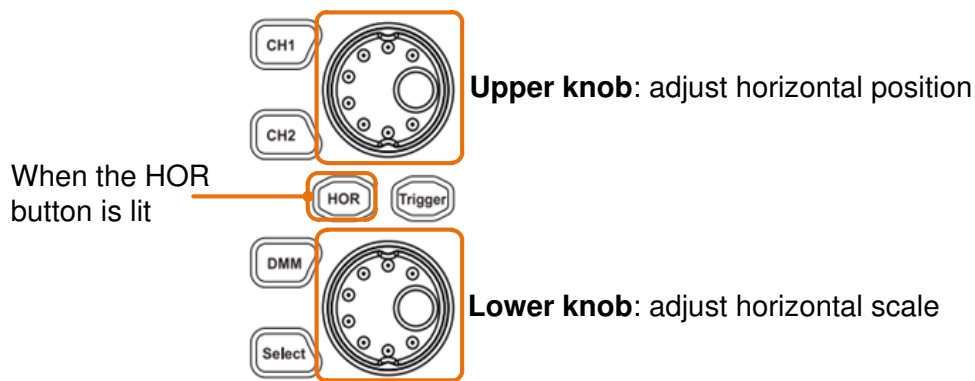

Figure 3-11 Horizontal Control

1. When the **HOR** button is lit, push the **HOR** button to switch between the normal mode and the wave zoom mode.
2. When the **HOR** button is lit, turn the lower knob to change the horizontal time base setting and observe the consequent status information change. Turn the lower knob to change the horizontal time base, and it can be found that the **Horizontal Time Base** displayed in the status bar changes accordingly.
3. When the **HOR** button is lit, use the upper knob to adjust the horizontal position of the signal in the waveform window. The upper knob is used to control the triggering displacement of the signal or for other special applications. If it is applied to triggering the displacement, it can be observed that the waveform moves horizontally with the knob when you rotate the upper knob.

Triggering displacement back to 0 shortcut key

Turn the upper knob to change the horizontal position of channel and push the upper knob to set the triggering displacement back to 0 as a shortcut key.

Introduction to the Trigger System

As shown in *Figure 3-12*, there are one knob and one button make up **Trigger Controls**. The following practices will direct you to be familiar with the setting of the trigger system gradually.

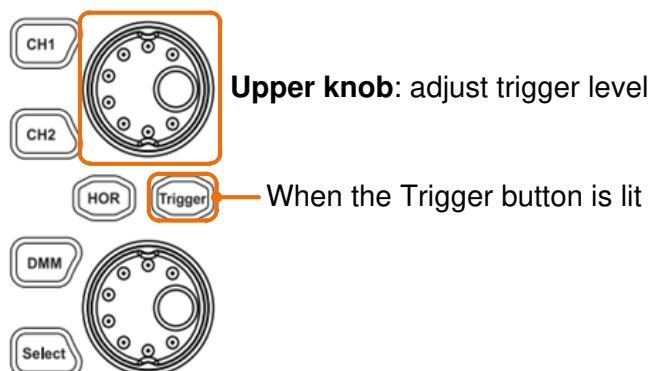







Figure 3-12 Trigger Control Zone

1. Click the  icon on the right bottom of the display area, click **Trig Menu** to call out the trigger menu in the bottom. The trigger setting can be changed.
2. When the **Trigger** button is lit, use the upper knob to change the trigger level setting.
By turning the upper knob, the trigger indicator in the screen will move up and down. With the movement of the trigger indicator, it can be observed that the trigger level value displayed in the screen changes accordingly.
Note: Turning the upper knob can change trigger level value and it is also the hotkey to set trigger level as the vertical mid-point values of the amplitude of the trigger signal.
3. Click the **Ready** on the left top of the display area to force a trigger signal, which is mainly applied to the "Normal" and "Single" trigger modes.

Touchscreen Controls

You can control the oscilloscope by different gestures. The touchable icon at the top right of the screen is used to enable () or disable () the touchscreen controls.

The instruction of touchscreen controls is as below.

- **Run/Stop:** Click the  or  on the left top of the display area to run or stop the waveform sampling.
- **Force trigger:** Click the **Ready** on the left top of the display area to force a trigger signal, which is mainly applied to the "Normal" and "Single" trigger modes.
- **Autoset:** Click the  on the left top of the display area to auto set.
- **Select a menu item:** Touch the menu items in the bottom menu, or in the right menu, or in the left menu.
- **Switch menu items:** If there are options that can be switched on the menu, you can repeatedly touch the area of the menu item to switch, or push the corresponding button to switch. See figure below:



Press repeatedly to
switch the options

- **Adjust value on the menu item:**

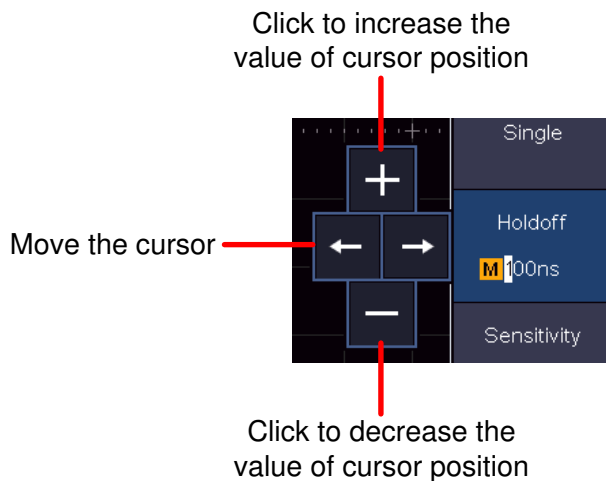

- **Scroll the list:** If there is a scroll bar in the left menu, you can swipe up and down to scroll the list.
- **Touchable menu panel:** Click the  icon on the right bottom of the display area, a menu will be shown. Click to enter the corresponding function menu.

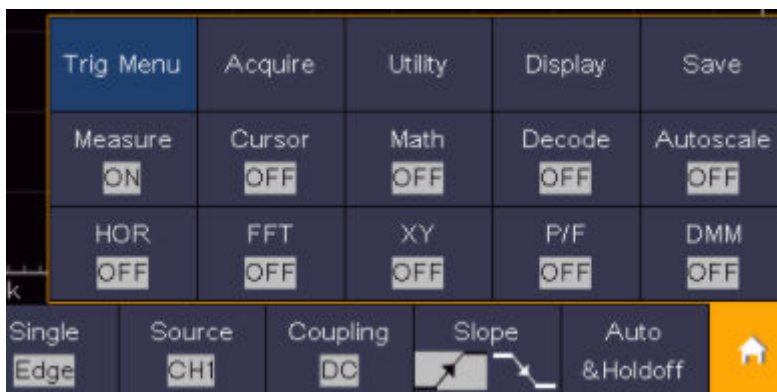

When **OFF** is shown, click to turn on the function, and enter the menu.
 When **ON** is shown and unselected, click to enter the menu, click again to turn off.

- **Set the channel status:** Click the channel on the left bottom of the display area, you can turn on, select or turn off the channel. You can also touch the channel pointer on the left side of the display area to make it in selected state.



- **Set the horizontal and vertical position**

Click in the area as shown in the figure below, the **P** icon will appear. Click anywhere outside the icon to hide it.

Note: Swipe up/down or left/right in this area, you can make the icon appear and control it.

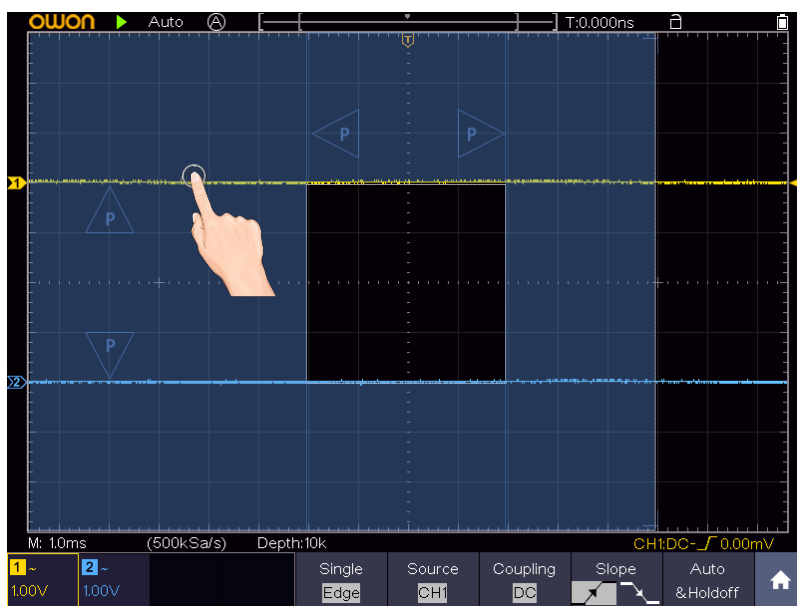

When the **P** icon appears, in the full screen, swipe left/right to control the horizontal position, swipe up/down to control the vertical position of the selected channel.

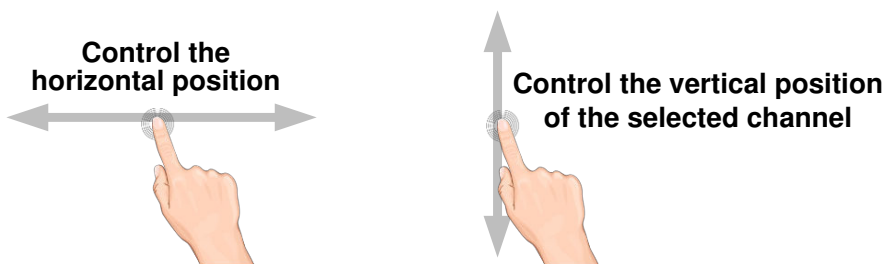

Click the **P** icon to fine-turn, long-press to adjust continuously.



- **Set the trigger level**

Click in the area as shown in the figure below, the **L** icon will appear. Click anywhere outside the icon to hide it.

Note: Swipe up/down in this area, you can make the icon appear and control it.

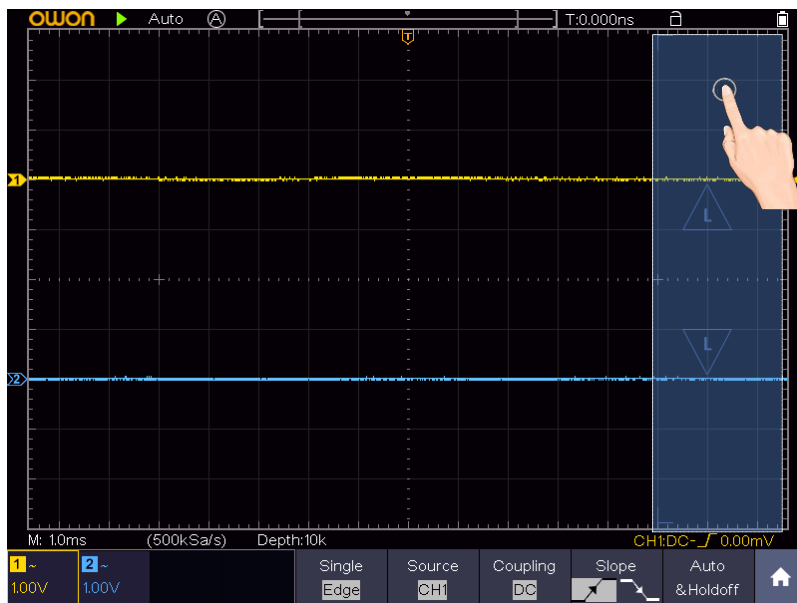

When the **L** icon appears, in the full screen, swipe up/down to control the trigger level of the source in the trigger menu.

Click the **L** icon to fine-turn, long-press to adjust continuously.

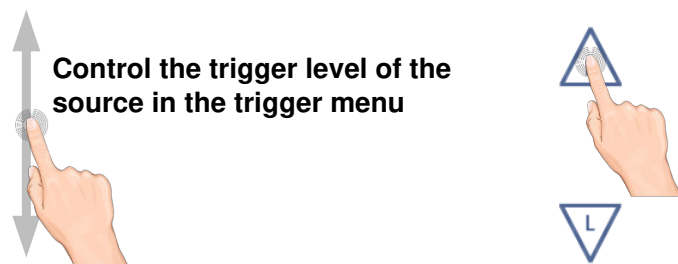

● **Set the time base and the voltage division**

Click in the area as shown in the figure below, the **M** and **V** icons will appear. Click anywhere outside the icon to hide it.

Note: Swipe up/down or left/right in this area, you can make the icon appear and control it.

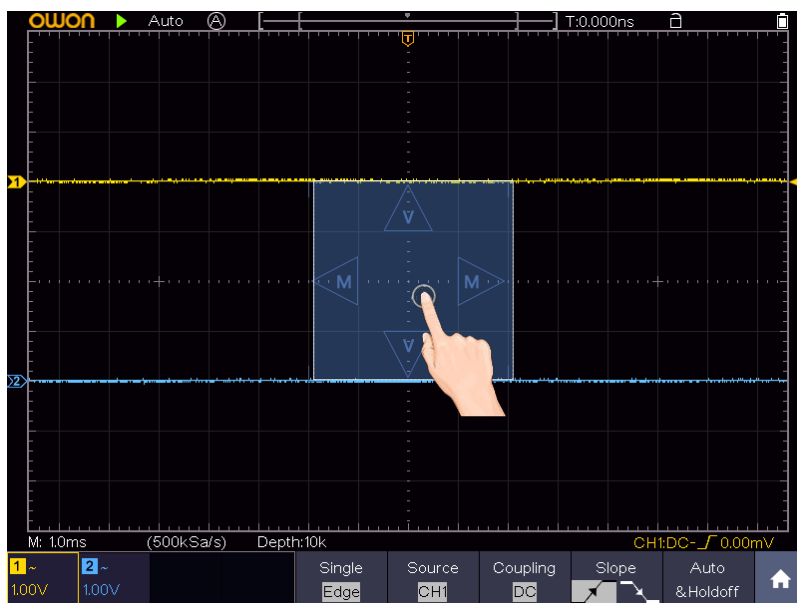

When the **M** and **V** icons appear, in the full screen, swipe left/right to change the time base, swipe up/down to change the voltage division of the selected channel.

Click the icons to fine-tune, long-press to adjust continuously.

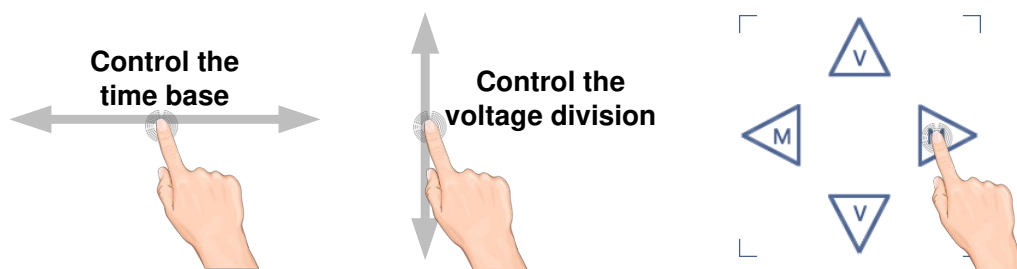

In the full screen, pinch and spread horizontally to change the time base; pinch and spread vertically to change the voltage division of the selected channel.



- **Measure with Cursors**

Click nearby a cursor line as shown in the figure below, the line will be selected, and the **C** icon will appear. Click anywhere outside the icon to hide it.

Note: Swipe in this area, you can make the icon appear and control it.

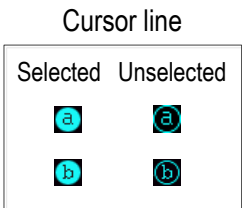
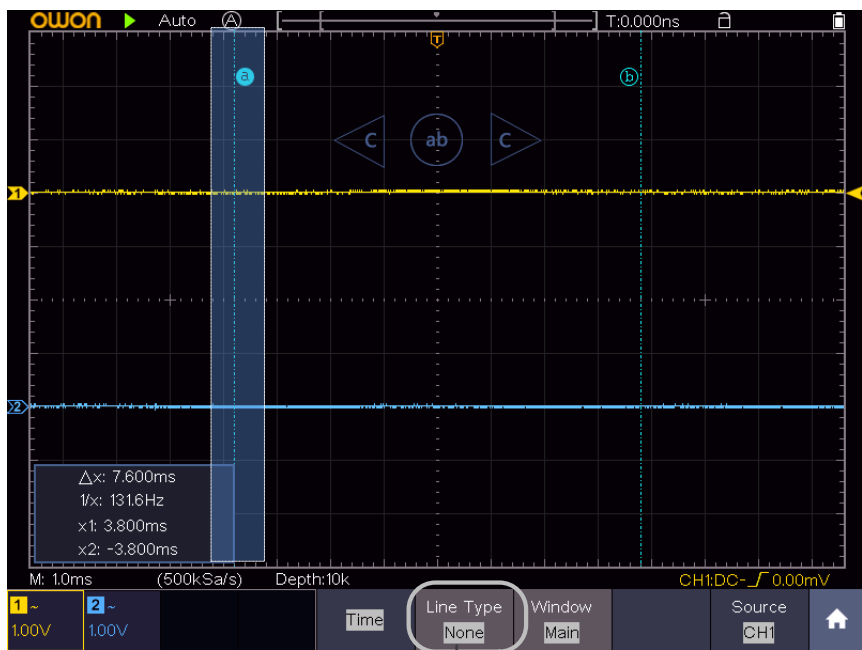

Switch horizontal or vertical lines
 If vertical lines are selected, drag up and down.

When the **C** icon appears, in the full screen, swipe left/right to move the selected line.

Click the direction buttons of the **C** icon to fine-turn, long-press to move continuously. Click the center "ab" button to select a, b, or a&b.

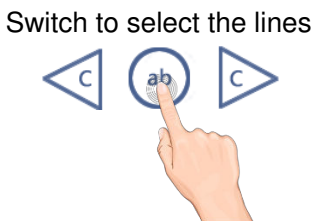
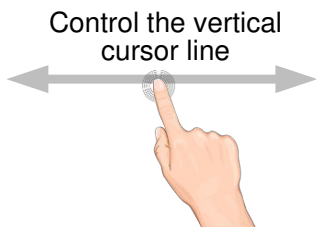

4. Advanced User Guidebook

Up till now, you have already been familiar with the basic operations of the function areas, buttons and knobs in the front panel of the oscilloscope. Based the introduction of the previous Chapter, the user should have an initial knowledge of the determination of the change of the oscilloscope setting through observing the status bar. If you have not been familiar with the above-mentioned operations and methods yet, we advise you to read the section of Chapter 3 "Junior User Guidebook".

This chapter will deal with the following topics mainly:

- **How to Set the Vertical System**
- **How to Set the Horizontal System**
- **How to Set the Trigger/Decoding System**
- **How to Implement the Sampling Setup**
- **How to Implement the Auxiliary System Function Setting**
- **How to Set the Display System**
- **How to Save and Recall Waveform**
- **How to Record/Playback Waveforms**
- **How to Clone and Recall a waveform**
- **How to Update your Instrument Firmware**
- **How to Measure Automatically**
- **How to Customize an Automatic Measurement**
- **How to Measure with Cursors**
- **How to Use Mathematical Manipulation Function**
- **How to Use Autoscale function**
- **How to Use HOR function**
- **How to Use FFT function**
- **How to Use XY format**
- **How to Use Pass/Fail function**
- **How to Use Executive Buttons**
- **How to Print the Screen Image**

It is recommended that you read this chapter carefully to get acquainted the various measurement functions and other operation methods of the oscilloscope.

How to Set the Vertical System

The **VERTICAL CONTROLS** include two menu buttons such as **CH1**, **CH2**, and two knobs such as **the upper knob**, **the lower knob**.

Setting of CH1, CH2

Each channel has an independent vertical menu and each item is set respectively based on the channel.

To turn channel waveforms on or off

Pushing the **CH1**, **CH2** buttons have the following effect:

- If the waveform is off, the waveform is turned on and its menu is displayed.
- If the waveform is on and its menu is not displayed, its menu will be displayed.
- If the waveform is on and its menu is displayed, the waveform is turned off and its menu goes away.

The description of the Channel Menu is shown as the following list:

Function Menu	Setting		Description
Coupling	DC		Pass both AC and DC components of the input signal.
	AC		Block the DC component of the input signal.
	GROUND		Disconnect the input signal.
Inverted	ON		Display inverted waveform.
	OFF		Display original waveform.
Probe	Attenu	0.001X to 1000X	Step by 1 – 2 – 5. Match this to the probe attenuation factor to have an accurate reading of vertical scale.
	MeasCurr	Yes No	If you are measuring current by probing the voltage drop across a resistor, choose Yes .
	A/V (mA/V) V/A (mV/A)		Click + or - to set the Amps/Volts ratio. The range is 100 mA/V - 1 KA/V. Amps/Volts ratio = 1/Resistor value Volts/Amp ratio is automatically calculated.
Limit	Full band		Get full bandwidth.
	20M		Limit the channel bandwidth to 20MHz to reduce display noise.

1. To set channel coupling

Taking the Channel 1 for example, the measured signal is a square wave signal containing the direct current bias. The operation steps are shown as below:

- (1) Push the **CH1** button to show the CH1 SETUP menu.

- (2) Select **Coupling** in the bottom menu.
- (3) Select **DC** in the right menu. Both DC and AC components of the signal are passed.
- (4) Select **AC** in the right menu. The direct current component of the signal is blocked.

2. To adjust the probe attenuation

For correct measurements, the attenuation coefficient settings in the operating menu of the Channel should always match what is on the probe (see "*How to Set the Probe Attenuation Coefficient*" on P11). If the attenuation coefficient of the probe is 1:1, the menu setting of the input channel should be set to X1.

Take the Channel 1 as an example, the attenuation coefficient of the probe is 10:1, the operation steps are shown as follows:

- (1) Push the **CH1** button to show the CH1 SETUP menu.
- (2) Select **Probe** in the bottom menu. Select **Attenu** in the right menu, select **10X** in the left menu.

3. To measure current by probing the voltage drop across a resistor

Take the Channel 1 as an example, if you are measuring current by probing the voltage drop across a 1Ω resistor, the operation steps are shown as follows:

- (1) Push the **CH1** button to show CH1 SETUP menu.
- (2) Select **Probe** in the bottom menu. In the right menu, set **MeasCurr** as **YES**, the A/V ratio menu will appear below. Select it; Click **+** or **-** to set the Amps/Volts ratio. Amps/Volts ratio = 1/Resistor value. Here the A/V ratio should be set to 1.

4. To invert a waveform

Waveform inverted: the displayed signal is turned 180 degrees against the phase of the earth potential.

Taking the Channel 1 for example, the operation steps are shown as follows:

- (1) Push the **CH1** button to show the CH1 SETUP menu.
- (2) Select **Inverted** in the bottom menu, switch to **ON**. the waveform is inverted. Push again to switch to **OFF**, the waveform goes back to its original one.

5. To set bandwidth limit

When high frequency components of a waveform are not important to its analysis, the bandwidth limit control can be used to reject frequencies above 20 MHz.

Taking the Channel 1 for example, the operation steps are shown as below:

- (1) Push the **CH1** button to show CH1 SETUP menu.
- (2) Select **Limit** in the bottom menu.

- (3) Select **Full band** in the right menu. The high frequency of the signal will be allowed to pass.
- (4) Select **20M** in the right menu. The bandwidth is limited to 20 MHz. The frequencies above 20MHz will be rejected.

Use the upper knob and the lower knob

If you want to set the vertical position and vertical scale of a channel, press CH1 or CH2 at first to select the desired channel, then turn the upper knob to set the vertical position, turn the lower knob to set the vertical scale.

1. The **upper** knob is used to adjust the vertical positions of the selected waveforms.
The analytic resolution of this control knob changes with the vertical division. When the upper knob is rotated, the pointer of the earth datum point of the selected channel is directed to move up and down following the waveform, and the position message at the center of the screen would change accordingly (see *Figure 4-1*).
2. The **lower** knob is used to regulate the vertical resolution of the selected wave forms.
The sensitivity of the vertical division steps as 1-2-5. The vertical scale is displayed at the left bottom corner of the screen (see *Figure 4-1*).

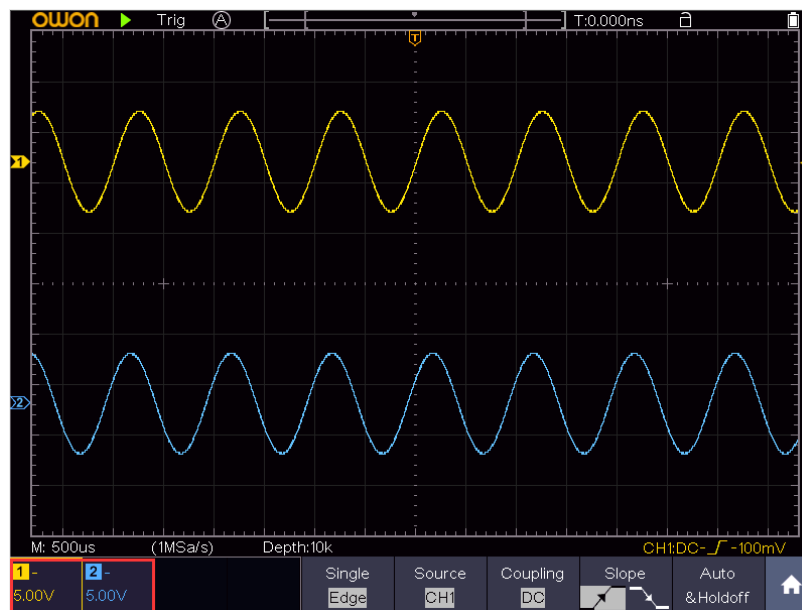

Figure 4-1 Information about Vertical Scale

How to Set the Horizontal System

Horizontal control system includes horizontal **HOR** key, the **upper knob** and the **lower knob**.

- **The upper knob:** When the **HOR** button is lit, adjust the horizontal positions of

all channels (including mathematical operations). The resolution of this knob changes with the time base.

- **The lower knob:** When the **HOR** button is lit, adjust the horizontal scale of waveform.
- Horizontal **HOR** key: Switch between the normal mode and the waveform zooming mode. When the magnifier is turned off, the waveform is magnified in the horizontal direction; when the magnifier is turned on, it can be magnified both horizontally and vertically.

Waveform Horizontal Zooming

Press the horizontal **HOR** button, enter the waveform horizontal zooming mode. The upper part of the display shows the main window and the lower part shows the horizontally zoomed window. The horizontal zoom window is the horizontally enlarged portion of the selected area in the main window.

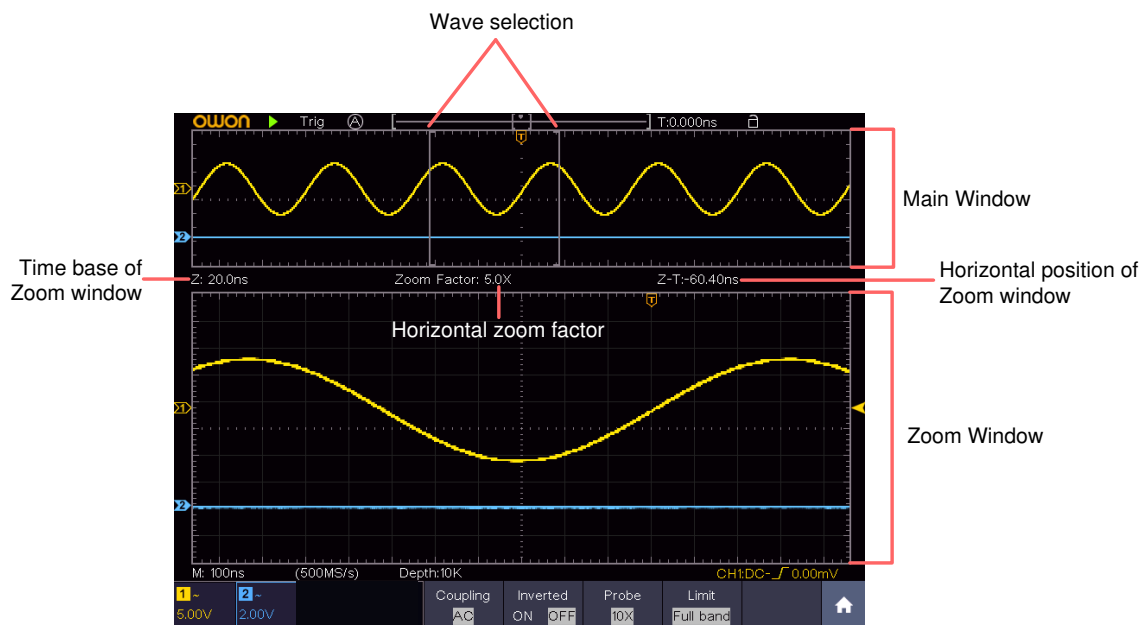

Figure 4-2 Waveform Horizontal Zooming Mode

In horizontal zoom mode, the upper knob adjusts the horizontal position of the horizontal zoom window. The lower knob adjusts the horizontal magnification, and the horizontal time base of the horizontal zoom window also changes.

Magnifier (For specific models)

After the magnifier function is turned on, the magnifier window can enlarge the waveform selection area horizontally and vertically so that the user can observe the waveform easily.

The steps to turn on and set the magnifier function are as follows:

- (1) Press the horizontal **HOR** key.

- (2) Select **Magnifier** from the bottom menu, and switch to **ON**.
- (3) Turn the lower knob to adjust the horizontal magnification. The horizontal time base of the magnifier window also changes.
- (4) Select **Ratio** from the bottom menu, select the vertical magnification in the left menu. The voltage scale of the magnifier window will also change accordingly.
- (5) Select **Window** from the bottom menu. Select **Vertical** in the right menu, click **+** or **-** to adjust the vertical position of the selection. Select **Hori** in the right menu, click **+** or **-** to adjust the horizontal position of the selection; you can also turn the upper knob to adjust it.

Magnifier settings menu description:

Function Menu	Setting	Description
Magnifier	ON	Turn on Magnifier
	OFF	Turn on Horizontal Zooming.
Ratio	2X	Set the vertical magnification. Because the magnifier window size does not change, the larger this multiple is, the smaller the vertical height of the waveform selection area is.
	4X	
	8X	
	16X	
	32X	
Window	Vertical	Set the vertical and horizontal position of the selection.
	Hori	

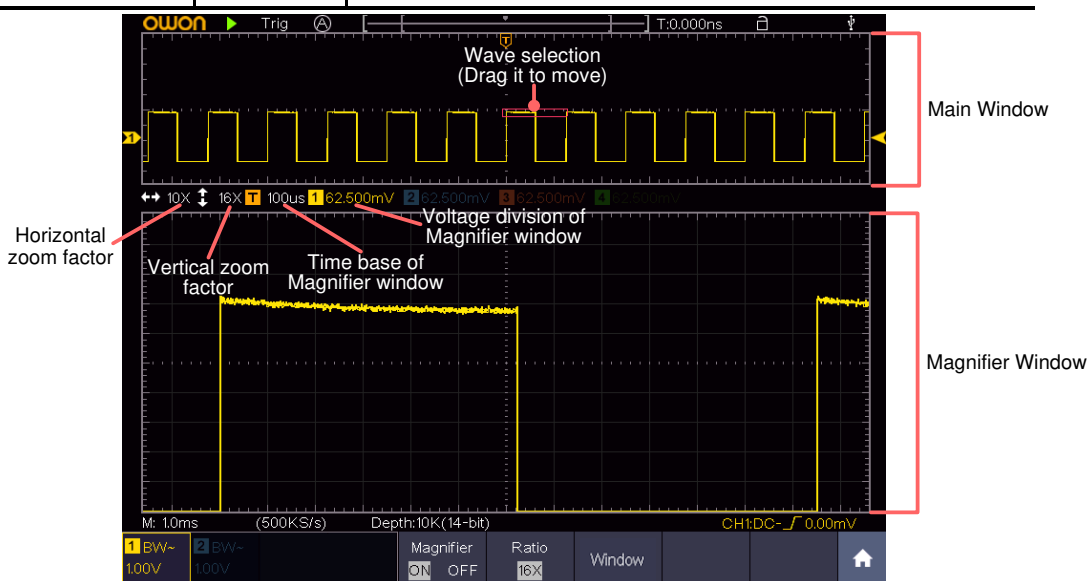
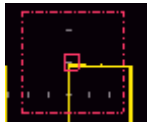

Figure 4-3 Magnifier Mode

Note:

- When the waveform is stopped, if the channel voltage scale is changed, the magnifier function will be turned off.
- You can drag the red selection box directly.
- It is recommended to set the performance mode to 14-bit, the effect after amplification is better.

- When the wave selection is small, a dotted box appears outside the selection to make the selection more recognizable.



Magnifier Window Cursor Measurement

When the magnifier function is on:

1. Click  to call up the menu panel.
2. Click the **Cursor** softkey on panel to switch to the **ON** state.
3. In the bottom menu, select **Window** as the **Main** or **Extension** to make the cursor line appear in the main window or magnifier window.

How to Operate the Function Menu

- **Menu panel**

Click the  icon on the right bottom of the display area, a menu panel will be shown. It has 15 function menu softkeys: **Trig Menu, Acquire, Utility, Display, Save, Measure, Cursor, Math, Decode, Autoscale, HOR, FFT, XY, P/F, DMM.**

- **Executive Buttons**

There are 5 executive buttons at the bottom right of the front panel: **Copy, Default, Run/Stop, Single, Autoset.**

Set the Trigger/Decoding System

Trigger determines when DSO starts to acquire data and display waveform. Once trigger is set correctly, it can convert the unstable display to meaningful waveform.

When DSO starts to acquire data, it will collect enough data to draw waveform on left of trigger point. DSO continues to acquire data while waiting for trigger condition to occur. Once it detects a trigger it will acquire enough data continuously to draw the waveform on right of trigger point.

Trigger control area consists of a knob and a menu button.

Upper knob: When the **Trigger** button is lit, the knob that set the trigger level; push the knob and the level will be set as the vertical mid-point values of the amplitude of the trigger signal.

Trigger button: The button that activates the trigger control menu.

Trigger Control

The oscilloscope provides three trigger types: single trigger, logic trigger and bus trigger. Each type of trigger has different sub menus.

Click  to call up the menu panel, click **Tig Menu**, select the first menu item in the bottom menu, select **Single**, **Logic** or **Bus** Trigger in the right menu, choose different trigger types in the left menu.

Single trigger: Use a trigger level to capture stable waveforms in two channels simultaneously.

Logic trigger: Trigger the signal according to the condition of logic relationship.

Bus trigger: Set bus timing trigger.

The **Single Trigger**, **Logic Trigger** and **Bus Trigger** menus are described respectively as follows:

Single Trigger

Single trigger has eight types: edge trigger, video trigger, pulse trigger, slope trigger, runt trigger, windows trigger, timeout trigger and Nth edge trigger.

Edge Trigger: It occurs when the trigger input passes through a specified voltage level with the specified slope.

Video Trigger: Trigger on fields or lines for standard video signal.

Pulse Trigger: Find pulses with certain widths.

Slope Trigger: The oscilloscope begins to trigger according to the signal rising or falling speed.

Runt Trigger: Trigger pulses that pass through one trigger level but fail to pass through the other trigger level.

Windows Trigger: Provide a high trigger level and low trigger level, the oscilloscope triggers when the input signal passes through the high trigger level or the low trigger level.

Timeout Trigger: The oscilloscope triggers when the time interval from when the rising edge (or the falling edge) passes through the trigger level to when the neighboring falling edge (or the rising edge) passes through the trigger level is greater than the timeout time set.

Nth Edge Trigger: The oscilloscope triggers on the Nth edge that appears on the specified idle time.



The eight trigger modes in Single Trigger are described respectively as follows:

1. Edge Trigger

An edge trigger occurs on trigger level value of the specified edge of input signal. Select Edge trigger mode to trigger on rising edge or falling edge.

In Edge Trigger mode, the trigger setting information is displayed on bottom right of the screen, for example, **CH1:DC-√0.00mV**, indicates that trigger type is edge, trigger source is CH1, coupling is DC, and trigger level is 0.00mV.

Edge menu list:

Menu	Setting	Instruction
Single	Edge	Set vertical channel trigger type as edge trigger.
Source	CH1 CH2	Channel 1 as trigger signal. Channel 2 as trigger signal.
Coupling	AC DC HF	Block the direct current component. Allow all component pass. Block the high-frequency signal, only low-frequency component pass.
Slope	 	Trigger on rising edge Trigger on falling edge
Mode	Auto	Acquire waveform even no trigger occurs
	Normal	Acquire waveform when trigger occurs
	Single	When trigger occurs, acquire one waveform then stop
Holdoff	Holdoff	100 ns - 10 s, click + or - to set time interval before another trigger occur, click ← → to move cursor to choose which digit to be set.
	Sensitivity	Set the trigger sensitivity.



Trigger Level: trigger level indicates vertical trig position of the channel, turn the trig level knob or slide on the touch screen upward and downward to move trigger level, during setting, an orange red dotted line displays to show trig position, and the value of trigger level changes at the right corner, after setting, dotted line disappears.

2. Video Trigger

Choose video trigger to trigger on fields or lines of NTSC, PAL or SECAM standard video signals.

In Video Trigger mode, the trigger setting information is displayed on bottom right of the screen, for example, **CH1:⏏ALL**, indicates that trigger type is Video, trigger source is CH1, and Sync type is Even.

Video Trigger menu list:

Menu	Setting	Instruction
Single	Video	Set vertical channel trigger type as video trigger
Source	CH1 CH2	Select CH1 as the trigger source Select CH2 as the trigger source
Modu	NTSC PAL SECAM	Select video modulation
Sync	Line Field Odd Even Line NO.	Synchronic trigger in video line Synchronic trigger in video field Synchronic trigger in video odd filed Synchronic trigger in video even field Synchronic trigger in designed video line, click  or  to set the line number
Mode Holdoff	Auto	Acquire waveform even no trigger occurred

3. Pulse Width Trigger

Pulse trigger occurs according to the width of pulse. The abnormal signals can be detected through setting up the pulse width condition.

In Pulse Width Trigger mode, the trigger setting information is displayed on bottom right of the screen, for example, , indicates that trigger type is pulse width, trigger source is CH1, coupling is DC, polarity is positive, and trigger level is 0.00mV.

Pulse Width Trigger menu list:

Menu	Setting	Instruction
Single	Pulse	Set vertical channel trigger type as pulse trigger.
Source	CH1 CH2	Select CH1 as the trigger source Select CH2 as the trigger source
Coupling	AC DC	Not allow DC portion to pass. Allow all portion pass.
when	Polarity 	Choose the polarity

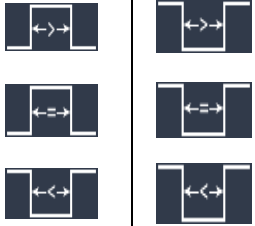

		Select pulse width condition and click + or - to set time, click ← → to move cursor to choose which digit to be set.
Mode	Auto	Acquire waveform even no trigger occurred
	Normal	Acquire waveform when trigger occurred
	Single	When trigger occurs, acquire one waveform then stop
	Holdoff	100 ns - 10 s, click + or - to set time interval before another trigger occur, click ← → to move cursor to choose which digit to be set.
	Sensitivity	Set the trigger sensitivity.

4. Slope Trigger

Slope trigger sets the oscilloscope as the positive/negative slope trigger within the specified time.

In Slope Trigger mode, the trigger setting information is displayed on bottom right of the screen, for example, **CH1: $\nearrow \Delta 0.00\text{mV}$** , indicates that trigger type is slope, trigger source is CH1, slope is rising, 0.00mV is the differential between up level and low level threshold.

Slope trigger menu list:

Menu	Setting	Instruction
Single	Slope	Set vertical channel trigger type as slope trigger.
Source	CH1 CH2	Select CH1 as the trigger source Select CH2 as the trigger source
When	slope 	Slope selecting
		Set slope condition; click + or - to set slope time, click ← → to move cursor to choose which digit to be set.
Threshold & SlewRate	High level Low level Slew rate	Click + or - to set the High level upper limit. Click + or - to set Low level lower limit. Slew rate = (High level - Low level) / Settings
Mode	Auto	Acquire waveform even no trigger occurred
	Normal	Acquire waveform when trigger occurred

Holdoff	Single	When trigger occurs, acquire one waveform then stop
	Holdoff	100 ns – 10 s, click + or - to set time interval before another trigger occur, click ← → to move cursor to choose which digit to be set.

5. Runt Trigger



Trigger pulses that pass through one trigger level but fail to pass through the other trigger level. Shown as below figure,

In Runt Trigger mode, the trigger setting information is displayed on bottom

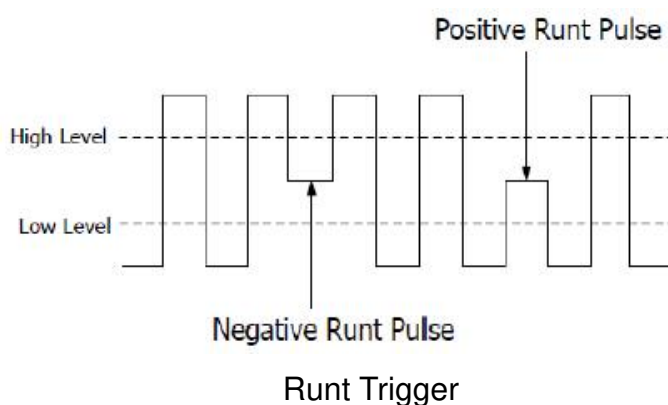
right of the screen, for example, **CH1: Δ 0.00mV**, indicates that trigger type is runt, trigger source is CH1, polarity is positive, 0.00mV is the differential between up level and low level threshold.



Runt Trigger menu list:

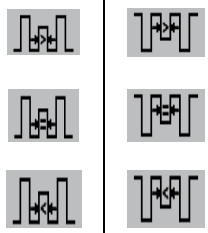

Menu	Setting	Instruction
Single	Runt	Set vertical channel trigger type as runt trigger.
Source	CH1 CH2	Select CH1 as the trigger source Select CH2 as the trigger source
Threshold	Up Level Low Level	Click + or - to set the up level threshold. Click + or - to set the low level threshold.
Condition	Polarity  	Positive Polarity, the oscilloscope triggers on the positive runt pulse. Negative Polarity, the oscilloscope triggers on the negative runt pulse.

		<p>Click + or - to set pulse width, click ← → to move cursor to choose which digit to be set.</p> <p>Trigger when runt pulse is greater than the set pulse width.</p> <p>Trigger when runt pulse equals to the set pulse width.</p> <p>Trigger when runt pulse is lower than the set pulse width.</p>
Mode	Auto	Acquire waveform even no trigger occurred
	Normal	Acquire waveform when trigger occurred
	Single	When trigger occurs, acquire one waveform then stop
Holdoff	Holdoff	100 ns - 10 s, click + or - to set time interval before another trigger occur, click ← → to move cursor to choose which digit to be set.

6. Windows Trigger

Provide a high trigger level and low trigger level, the oscilloscope triggers when the input signal passes through the high trigger level or the low trigger level. In Windows Trigger mode, the trigger setting information is displayed on bottom right of the screen, for example, **CH1: μ n Δ 0.00mV**, indicates that trigger type is windows, trigger source is CH1, polarity is positive, 0.00mV the differential between up level and low level threshold.

Windows Trigger menu list:

Menu	Setting	Instruction
Single	Windows	Set vertical channel trigger type as Windows trigger.
Source	CH1 CH2	Select CH1 as the trigger source Select CH2 as the trigger source
Threshold	Up Level Low Level	Click + or - to set the up level threshold. Click + or - to set the low level threshold.
Condition	Polarity  	Positive Polarity, the oscilloscope triggers on the positive Windows pulse. Negative Polarity, the oscilloscope triggers on the negative Windows pulse.

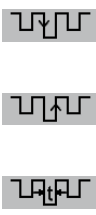
			<p>Enter: Triggers when the trigger signal enters the specified trigger level range.</p> <p>Exit: Triggers when the trigger signal exits the specified trigger level range.</p> <p>Time: Specify the hold time of the input signal after entering the specified trigger level. The oscilloscope triggers when the accumulated hold time is greater than the windows time. Available range is 30ns-10s, default 100ns.</p>
Mode	Auto	Acquire waveform even no trigger occurred	
	Normal	Acquire waveform when trigger occurred	
Holdoff	Single	When trigger occurs, acquire one waveform then stop	
	Holdoff	100 ns - 10 s, click + or - to set time interval before another trigger occur, click ← → to move cursor to choose which digit to be set.	

7. Timeout Trigger

The oscilloscope triggers when the time interval from when the rising edge (or the falling edge) passes through the trigger level to when the neighboring falling edge (or the rising edge) passes through the trigger level is greater than the timeout time set.

In Timeout Trigger mode, the trigger setting information is displayed on bottom right of the screen, for example, **CH1:  -150V**, indicates that trigger type is Timeout, trigger source is CH1, edge is positive, 0.00mV is up level or low level threshold.

Timeout Trigger menu list:

Menu	Setting	Instruction
Single	Timeout	Set vertical channel trigger type as Timeout trigger.
Source	CH1	Select CH1 as the trigger source
	CH2	Select CH2 as the trigger source
Edge	Edge	Start timing when the rising edge of the input signal passes through the trigger level.
		Start timing when the falling edge of the input signal passes through the trigger level.
Configure	Idle Time	Set idle time. Idle time means the minimum time of idle clock before searching data that can meet trigger conditions. Available range is 30ns-10s, default 100ns.

Mode	Auto	Acquire waveform even no trigger occurred
	Normal	Acquire waveform when trigger occurred
	Single	When trigger occurs, acquire one waveform then stop
Holdoff	Holdoff	100 ns - 10 s, click + or - to set time interval before another trigger occur, click ← → to move cursor to choose which digit to be set.
	Sensitivity	Set the trigger sensitivity.

8. Nth Edge trigger

The oscilloscope triggers on the Nth edge that appears on the specified idle time. As figure shown below, the oscilloscope should trigger on the second falling edge after the specified idle time and the idle time should be set to $P1/P2/P3/P4 < \text{Idle Time} < M$. Wherein, M, P1, P2, P3 and P4 are positive or negative pulse width participating in the counting.

In Nth Edge Trigger mode, the trigger setting information is displayed on bottom right of the screen, for example, **CH1:Nth0.00mV**, indicates that trigger type is Nth Edge, trigger source is CH1, -150V is up level or low level threshold.

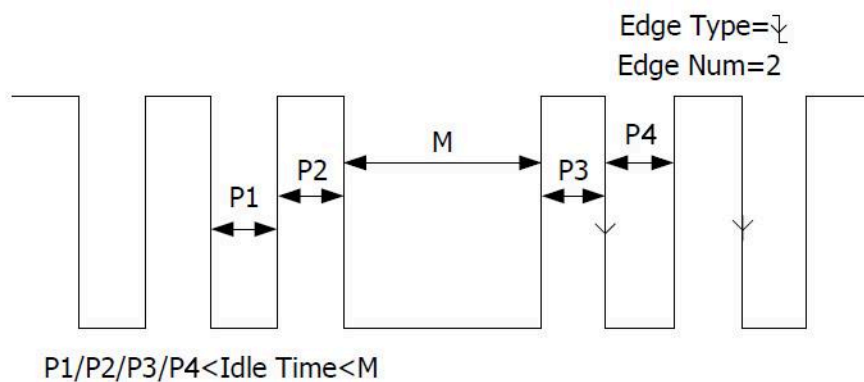

Nth Edge Trigger

Nth Edge Trigger menu list:

Menu	Setting	Instruction
Single	Nth Edge	Set vertical channel trigger type as Nth Edge trigger.
Source	CH1	Select CH1 as the trigger source
	CH2	Select CH2 as the trigger source

Edge	Edge 	Trigger on the rising edge of the input signal when voltage level meets the specified trigger level. Trigger on the falling edge of the input signal when voltage level meets the specified trigger level.
Configure	Idle Time	Set idle time before the edge counting in Nth Edge Trigger. Click + or - to set idle time, click ← → to move cursor to choose which digit to be set. Available range is 30ns-10s, default 100ns.
	Edge Num	Set the edge number value of “N” in Nth Edge trigger.
Mode	Auto	Acquire waveform even no trigger occurred
	Normal	Acquire waveform when trigger occurred
	Single	When trigger occurs, acquire one waveform then stop
Holdoff	Holdoff	100 ns - 10 s, click + or - to set time interval before another trigger occur, click ← → to move cursor to choose which digit to be set.
	Sensitivity	Set the trigger sensitivity.

Logic Trigger

Trigger according to logic relation.

In Logic Trigger mode, the trigger setting information is displayed on bottom right of the screen, for example, **CH1>HHHH>CH4**  **CH1: H 0.00mV**, indicates that trigger type is Logic, logic mode is AND, CH1 high level and trigger level is 0.00mV.

Logic Trigger menu list:

Menu	Setting	Instruction
Mode	Logic	Set vertical channel trigger type as Logic trigger.
Logic Mode	AND	Set logic mode as AND.
	OR	Set logic mode as OR.
	XNOR	Set logic mode as XNOR.
	XOR	Set logic mode as XOR.
Input Mode	CH1	Set CH1 as High Level, Low level, high or low level, Rise and Fall.
	CH2	Set CH2 as High Level, Low level, high or low level, Rise and Fall. Note: When input mode of one channel is set as Rise or Fall, the other channel could not be set as Rise and Fall at the same time.

Out Mod	Goes True	Trigger when condition turns True from False.
	Goes False	Trigger when condition turns False from True.
	Is True >	Trigger when the time of true condition is greater than the set time
	Is True =	Trigger when the time of true condition is equal to the set time
	Is True <	Trigger when the time of true condition is lower than the set time
Mode	Auto	Acquire waveform even no trigger occurred
	Normal	Acquire waveform when trigger occurred
	Single	When trigger occurs, acquire one waveform then stop
Holdoff	Holdoff	100 ns - 10 s, click + or - to set time interval before another trigger occur, click ← → to move cursor to choose which digit to be set.
	Sensitivity	Set the trigger sensitivity.

Bus Trigger

1. UART Trigger

UART is a serial communication mode used in the data transmission between PCs or between PC and Terminal. A character is transmitted as a frame of data which consist of 1bit start bit, 5-8bits data bits, 1bit check bit and 1-2 stop bits. In UART bus trigger mode, the trigger setting information is displayed on bottom right of the screen, for example, **UART CH1:50.0V** , indicates that trigger type is UART, CH1 trigger level is 0.00mV. Format as shown in the figure below,

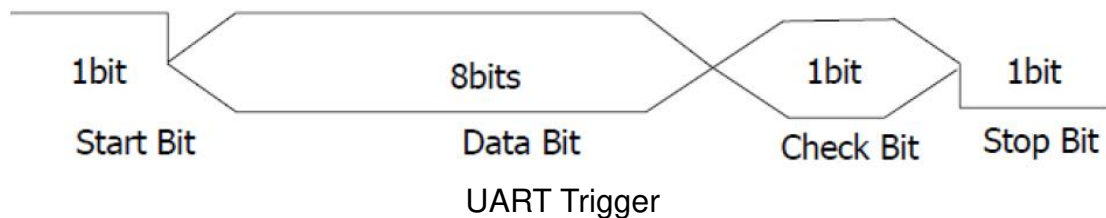

UART Trigger menu list:

Menu	Setting	Instruction
Bus Type	UART	Set vertical channel bus type as UART trigger.

Input	Source	CH1 CH2	Select CH1 as the trigger source. Select CH2 as the trigger source.
	Polarity	Normal	Select polarity of data transmission as Normal.
		Inverted	Select polarity of data transmission as Inverted.
When	Start		Trigger on the start frame of position. After choosing this condition, press Configure to enter detailed settings.
	Error		Trigger when error frame is detected. After choosing this condition, press Configure to enter detailed settings.
	Chk Error		Trigger when Chk Error is detected. After choosing this condition, press Configure to enter detailed settings.
	Data		Trigger on the last bit of the preset data. After choosing this condition, press Configure to enter detailed settings.
Configure	Start		Common Baud: click in the left menu to choose common baud. Custom Baud: click + or - choose baud, ranges from 50 to 10,000,000.
	Error		Stop Bit: Select "1" or "2". Parity: Select None, Odd, or Even Common Baud: click in the left menu to choose common baud. Custom Baud: click + or - to choose baud, ranges from 50 to 10,000,000.
	Chk Error		Parity: Select Odd or Even. Common Baud: click in the left menu to choose common baud. Custom Baud: click + or - to choose baud, ranges from 50 to 10,000,000.
	Data		Data Bits: Set as 5, 6, 7, 8 bits. Data: Set data according to data bits, ranges from 0-31, 0-63, 0-127 or 0-255. Common Baud: click in the left menu to choose common baud. Custom Baud: click + or - to choose baud, ranges from 50 to 10,000,000.
Mode	Auto		Acquire waveform even no trigger occurred

Holdoff	Normal	Acquire waveform when trigger occurred
	Single	When trigger occurs, acquire one waveform then stop

2. I2C Trigger

The I2C serial bus consists of SCL and SDA. The transmission rate is determined by SCL, and the transmission data is determined by SDA. As shown in below figure, oscilloscope can trigger on the start, restart, stop, ack lost, specific device address or data value, also device address and data value at the same time.

In I2C bus trigger mode, the trigger setting information is displayed on bottom right of the screen, for example, **I2C CH1:0.00mV**, indicates that trigger type is I2C, CH1 trigger level is 0.00mV.

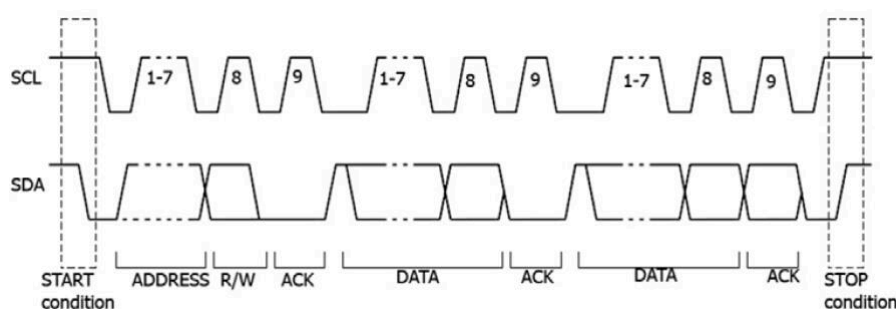

I2C Trigger menu list:

Menu	Setting	Instruction
Bus Type	I2C	Set vertical channel bus type as I2C trigger.
Source	SCL SDA	Set SCL. Set SDA.
When	Start	Trigger when SDA data transitions from high to low while SCL is high.
	Restart	When another start condition occurs before a stop condition.
	Stop	Trigger when SDA data transitions from low to high while SCL is high.
	Ack Lost	Trigger when SDA data is high during any acknowledgement of SCL clock position.
	Addr	Trigger on the read or write bit when the preset address is met.

	Adr Format	Addr Bits	Set Address Bits to be “7”, “8” or “10”.
		Addr	Set address according to the preset address bits, address range is 0-127, 0-255, 0-1023 respectively.
		Direction	Set Data Direction to be Write or Read . Note: The set is not available when Address bits is set to “8”.
	Data		Search for the preset data value on SDA and trigger on the dump edge of SCL of the last bit of the data area.
	Dat Format	Byte Length	Set data byte length, available range 1-5 bytes. Click + or - to set byte length.
		Current Bit	Select the data bit, ranges from 0 to (byte length*8 -1).
		Data	Set data to be H, L, or X (H or L)
		All Bits	Set all the data bits to be the specified value in Data
	Addr/Data		Trigger when Address and Data conditions are met at the same time.
	Mode	Auto	Acquire waveform even no trigger occurred
Holdoff	Normal	Acquire waveform when trigger occurred	
	Single	When trigger occurs, acquire one waveform then stop	



3. SPI Trigger

Trigger on the specified data when the timeout condition is meet. When using SPI trigger, you need to specify the SCL and SDA data sources.

In SPI bus trigger mode, the trigger setting information is displayed on bottom right of the screen, for example, **SPI CH1:0.00mV**, indicates that trigger type is SPI, CH1 trigger level is 0.00mV.

SPI Trigger menu list:

Menu	Setting	Instruction
Bus Type	SPI	Set vertical channel bus type as SPI trigger.
Source	SCL SDA	Set SCL. Set SDA.
Time Out	Time out	Set the minimum time that SCL must be idle, that is a period of SCL, available range 100ns-10s.

		Time out means SCL keeps idle for a specified time before oscilloscope starts to search for the data (SDA) on which to trigger. Click + or - to set time out, click ← → to move cursor to choose which digit to be set.
ClockEdge &Data	Clock Edge	Set Clock Edge as rising edge or falling edge. Means sample the SDA data on the rising edge or falling edge of the clock.
	 	
	Data Bits	Set the number of bits of the serial data character string. It can be set to any integer between 4-32. Click + or - to set Data Bits.
	Current Bit	Set the number of the data bits, ranges from 0-31, click + or - to set Current Bit.
	Data	Set the value of the current data bit as H, L, or X (H or L).
	All Bits	Set all the data bits to be the specified value in Data.
Mode	Auto	Acquire waveform even no trigger occurred
	Normal	Acquire waveform when trigger occurred
Holdoff	Single	When trigger occurs, acquire one waveform then stop

4. CAN Trigger (Optional)

CAN (Controller Area Network) is a serial communication protocol of the ISO international standardization.

By using the CAN bus trigger, you can trigger on **Start of Frame**, **Type of Frame**, **Identifier**, **Data**, **ID & Data**, **End of Frame**, **Missing Ack**, or **Bit Stuffing Error**. You need to specify the signal source, trigger signal type, sample point, and signal rate of the CAN signal.

In CAN bus trigger mode, the trigger setting information is displayed on bottom right of the screen, for example, **CAN CH1:-126mV**, indicates that trigger type is CAN, CH1 trigger level is -126 mV.

CAN Trigger menu list:

Menu	Setting	Instruction
Bus Type	CAN	Set vertical channel bus type as CAN trigger.

Input	Source	CH1 CH2	Select CH1 as the trigger source. Select CH2 as the trigger source.
	Type	CAN_H CAN_L TX RX	Actual CAN_H bus signal. Actual CAN_L bus signal. Transmission signal on the CAN signal line. Received signal on the CAN signal line.
	Sample Point	Click + or - to set the Sample point, which is a point within a bit's time. The oscilloscope samples the bit level at this point. "Sample point" is represented by the percentage of "the time from the start of the bit's time to the sample point time" in the "bit's time". The range is 5% to 95%.	
	Common Baud	Select from the Baud list on the left.	
	Custom Baud	Click + or - to set the Baud. The range is 10,000 to 1,000,000. Tip: You can select the nearest value in Common Baud, and then adjust it in this menu.	
Condition	Start	Trigger on the start frame of the data frame.	
	Type	Type (Bottom menu)	Data Remote Error Overload Trigger on the selected frame.
	ID	Configure (Bottom menu)	Format ID Select Standard or Extend . Click + or - to set value, click ← → to move cursor.
	Data	Configure (Bottom menu)	Byte Length Data Click + or - to set the number of bytes. The range is 1 to 8. Click + or - to set value, click ← → to move cursor.
	ID&Data	Configure (Bottom menu)	Format ID Byte Length Data Select Standard or Extend . Click + or - to set value, click ← → to move cursor. Click + or - to set the number of bytes. The range is 1 to 8. Click + or - to set value, click ← → to move cursor.

	End	Trigger on the end frame of the data frame.
	Lost	Trigger on Missing Ack.
	Error	Trigger on Bit Stuffing Error.
Mode	Auto	Acquire waveform even no trigger occurred
	Normal	Acquire waveform when trigger occurred
Holdoff	Single	When trigger occurs, acquire one waveform then stop

Bus Decoding (Optional)

1. UART Decoding

To decode UART signal:



- (1) Connect the UART signal to the signal input channel of the oscilloscope.
- (2) Adjust to the proper time base and voltage division.
- (3) In trigger menu, select Bus trigger, and select bus type as UART, set parameters based on the characteristics of the signal, trigger the signal correctly and obtain stable display. Refer to "*UART Trigger*" on page 38.
- (4) Click  to call up the menu panel. Click the **Decode** softkey on panel to switch to the **ON** state. Select bus type as UART, set parameters based on the characteristics of the signal. When the parameters are set correctly, the information carried by the signal will be displayed.

Tip: If there are repetitive menu items in both trigger menu and decoding menu, you can set anyone of them, the other will be changed synchronously.

Note:

- Use the upper knob to adjust the thresholds of bus trigger and bus decoding.
- When decoding, if "Parity" is not set to "None", and the check bit error is detected, two red error marks will be displayed in the corresponding position in the waveform.

UART Decoding menu list:

Menu	Setting	Instruction
Bus Type	UART	Set bus type of decoding as UART.
Configure	Common Baud	Select from the Baud list on the left.
	Custom Baud	Click  or  to set the Baud. The range is 50 to 10,000,000. Tip: You can select the nearest value in Common Baud, and then adjust it in this menu.

	Data Bits	Set the data width of each frame to match the signal. It can be set to 5, 6, 7 or 8.	
	Parity	Set the even-odd check mode to match the polarity used by the signal.	
Display	Format	Binary Decimal Hex ASCII	Set the display format of the bus.
	Event Table	ON OFF	Select "ON" to display the event table.
	Save Event Table	If a USB storage device is currently connected to the instrument, save the event table data in a .csv (spreadsheet) formatted file on the external USB storage device.	
	ASCII Table	ON OFF	Select "ON" to display the ASCII table.

2. I2C Decoding

To decode I2C signal:

- (1) Connect the clock line (SCLK) and the data line (SDA) of the I2C signal to the Signal Input Channels of the oscilloscope.
- (2) Adjust to the proper time base and voltage division.
- (3) In trigger menu, select Bus trigger, and select bus type as I2C, set parameters based on the characteristics of the signal, trigger the signal correctly and obtain stable display. Refer to "I2C Trigger" on page 40.
- (4) Click  to call up the menu panel. Click the **Decode** softkey on panel to switch to the **ON** state. Select bus type as I2C. set parameters based on the characteristics of the signal. When the parameters are set correctly, the information carried by the signal will be displayed.

Tip: If there are repetitive menu items in both trigger menu and decoding menu, you can set any one of them, the other will be changed synchronously.

Decoded information interpretation:

Information	Abbreviation	Background
Read Address	R, Read, or do not display	Green
Write Address	W, Write, or do not display	Green
Data	D, Data, or do not display	Black

Note:

- Use the upper knob to adjust the thresholds of bus trigger and bus decoding.
- When the ACK (ACKnowledge Character) is not met, two red error marks

will be displayed in the corresponding position in the waveform.

I2C Decoding menu list:

Menu	Setting	Instruction	
Bus Type	I2C	Set bus type of decoding as I2C.	
Display	Format	Binary Decimal Hex ASCII	Set the display format of the bus.
	EventTable	ON OFF	Select "ON" to display the event table.
	Save EventTable	If a USB storage device is currently connected to the instrument, save the event table data in a .csv (spreadsheet) formatted file on the external USB storage device.	
	ASCII Table	ON OFF	Select "ON" to display the ASCII table.

3. SPI Decoding

To decode SPI signal:

- (1) Connect the clock line (SCLK) and the data line (SDA) of the SPI signal to the Signal Input Channels of the oscilloscope.
- (2) Adjust to the proper time base and voltage division.
- (3) In trigger menu, select Bus trigger, and select bus type as SPI, set parameters based on the characteristics of the signal, trigger the signal correctly and obtain stable display. Refer to "*SPI Trigger*" on page 41.
- (4) Click  to call up the menu panel. Click the **Decode** softkey on panel to switch to the **ON** state. Select bus type as SPI. set parameters based on the characteristics of the signal. When the parameters are set correctly, the information carried by the signal will be displayed.

Tip: If there are repetitive menu items in both trigger menu and decoding menu, you can set anyone of them, the other will be changed synchronously.

Note:

- Use the upper knob to adjust the thresholds of bus trigger and bus decoding.
- **LS First** in Bit Order menu item (Least Significant Bit First) means that the least significant bit will arrive first: hence e.g. the hexadecimal number 0x12, will arrive as the sequence 01001000 in binary representation, will

be decoded as the reversed sequence 00010010.

SPI Decoding menu list:

Menu	Setting	Instruction	
Bus Type	SPI	Set bus type of decoding as SPI.	
Configure	SCLK	Select the clock edge to match the signal, sample the SDA data on the rising or falling edge of the clock.	
	Time Out	Set the minimum time that the clock (SCL) signal must be idle before the oscilloscope starts to search for the data (SDA) on which to trigger. The range is 30 ns to 10 s.	
	Data Bits	Set the data width of each frame to match the signal. It can be set to any integer between 4 and 32.	
	Bit Order	Select LS First or MS First to match the signal.	
Display	Format	Binary Decimal Hex ASCII	Set the display format of the bus.
	EventTable	ON OFF	Select "ON" to display the event table.
	Save EventTable	If a USB storage device is currently connected to the instrument, save the event table data in a .csv (spreadsheet) formatted file on the external USB storage device.	
	ASCII Table	ON OFF	Select "ON" to display the ASCII table.

4. CAN Decoding

To decode CAN signal:

- (1) Connect the CAN signal to the Signal Input Channel of the oscilloscope.
- (2) Adjust to the proper time base and voltage division.
- (3) In trigger menu, select Bus trigger, and select bus type as CAN, set parameters based on the characteristics of the signal, trigger the signal correctly and obtain stable display. Refer to "*CAN Trigger*" on page 42.
- (4) Click  to call up the menu panel. Click the **Decode** softkey on panel to switch to the **ON** state. Select bus type as CAN. set parameters based on the characteristics of the signal. When the parameters are set correctly, the information carried by the signal will be displayed.

Tip: If there are repetitive menu items in both trigger menu and decoding menu,

you can set anyone of them, the other will be changed synchronously.

Decoded information interpretation:

Information	Abbreviation	Background
Identifier	I, ID, or do not display	Green
Overload Frame	OF	Green
Error Frame	EF	Green
Data Length code	L, DLC, or do not display	Blue
Data	D, Data, or do not display	Black
Cyclic Redundancy Check	C, CRC, or do not display	Valid: Purple Error: Red

Note:

- Use the upper knob to adjust the thresholds of bus trigger and bus decoding.
- When the ACK (ACKnowledge Character) of Data Frame or Remote Frame is not met, two red error marks will be displayed in the corresponding position in the waveform.
- Error Frame, Remote Frame, and Overload Frame will be identified in the "Data" column in the event table (Data Frame will not be identified).

CAN Decoding menu list:

Menu	Setting	Instruction	
Bus Type	CAN	Set bus type of decoding as CAN.	
Display	Format	Binary Decimal Hex ASCII	Set the display format of the bus.
	EventTable	ON OFF	Select "ON" to display the event table.
	Save EventTable	If a USB storage device is currently connected to the instrument, save the event table data in a .csv (spreadsheet) formatted file on the external USB storage device.	
	ASCII Table	ON OFF	Select "ON" to display the ASCII table.

Implement Sampling Setup

Click  to call up the menu panel. Click the **Acquire** softkey on panel, **Acqu**

Mode, Length, PERF Mode, and Intrpl is shown in the bottom menu.

The description of the **Acqu Mode** menu is shown as follows:

Function Menu	Setting	Description
Acqu Mode	Sample	Normal sampling mode.
	Peak Detect	Use to capture maximal and minimal samples. Finding highest and lowest points over adjacent intervals. It is used for the detection of the jamming burr and the possibility of reducing the confusion.
	Average	4, 16, 64, 128 It is used to reduce the random and don't-care noises, with the optional number of averages.
	Refresh Rate	<input type="checkbox"/> Low Set the waveform refresh rate, you can turn on this mode when you need to observe a single waveform

The description of the **Record Length** menu is shown as follows:

Function Menu	Setting	Description
Length	1000	Choose the record length Note: When two channels are turned on, the max record length is 20M; and max 40M for one channel.
	10K	
	100K	
	1M	
	10M	
	20M	
	40M	

The description of **PERF Mode** menu is shown as follows:

Function Menu	Setting	Description
PERF Mode	8-bit	Set the vertical resolution (A/D)
	12-bit	
	14-bit	

The description of the **Intrpl** menu is shown as follows:

Function Menu	Setting	Description
Intrpl	Sinx/x	Use sine(x)/x interpolation
	x	Use linear interpolation

Interpolation method is a processing method to connect the sampled points, using some points to calculate the whole appearance of the waveform. Select the appropriate interpolation method according to the actual signal.

Sine(x)/x interpolation: Connect the sampled points with curved lines.

Linear interpolation: Connect the sampled points with straight lines. This

method is suitable to rebuild the straight-edged signals, such as square or pulse wave.

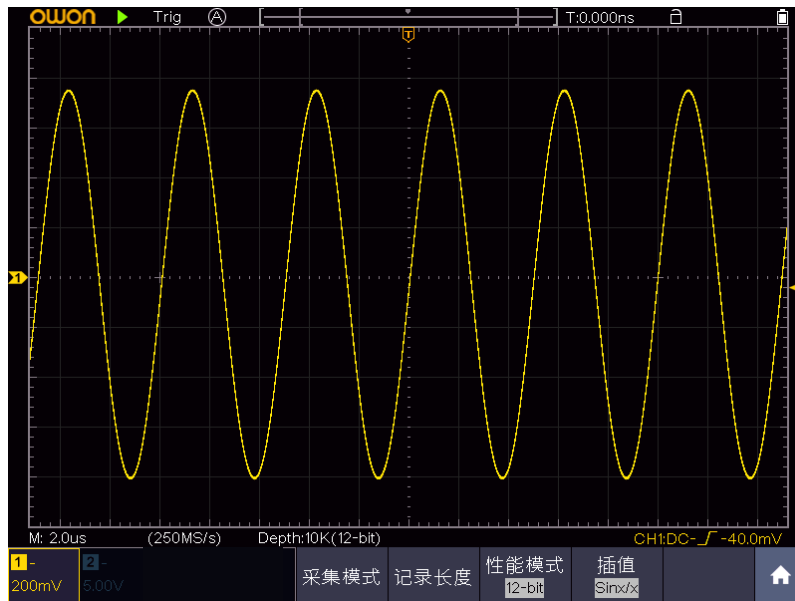

Figure 4-4 Sine(x)/x interpolation

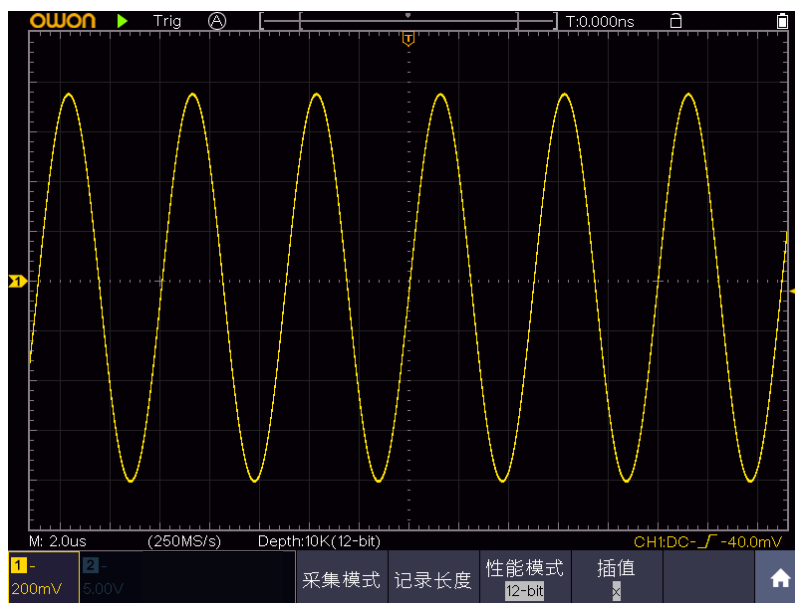

Figure 4-5 Linear interpolation

Implement the Auxiliary System Function Setting

●Config

Click  to call up the menu panel. Click the **Utility** softkey on panel, select **Function** in the bottom menu, select **Configure** in the left menu.

The description of **Configure Menu** is shown as the follows:

Function Menu	Setting	Description
Language		Choose the display language of the operating system.
Set Time	Display ON OFF	On/Off the date display
	Hour Min	Setting Hour/Minute
	Day Month	Setting Date/Month
	Year	Setting Year
KeyLock		Lock all keys. Unlock method: push HOR button, then push Trigger button, repeat 3 times.
About		Show serial number, version, and checksum

●Display

Click  to call up the menu panel. Click the **Utility** softkey on panel, select **Function** in the bottom menu, select **Display** in the left menu.

The description of **Display Menu** is shown as the follows:

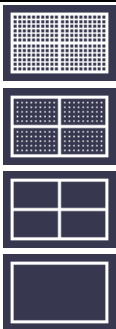
Function Menu	Setting	Description
BackLight	0% - 100%	Adjust the backlight.
Graticule		Select the grid type
Battery	ON OFF	Turn on or off the battery display
Menu Time	OFF, 5s - 30s	Set the disappear time of menu

●Adjust

Click  to call up the menu panel. Click the **Utility** softkey on panel, select **Function** in the bottom menu, select **Adjust** in the left menu.

The description of **Adjust Menu** is shown as the follows:

Function Menu	Description
Self Cal	Carry out the self-calibration procedure.
Default	Call out the factory settings.

ProbeCh.	Check whether probe attenuation is good.
----------	--

Do Self Cal (Self-Calibration)

The self-calibration procedure can improve the accuracy of the oscilloscope under the ambient temperature to the greatest extent. If the change of the ambient temperature is up to or exceeds 5°C, the self-calibration procedure should be executed to obtain the highest level of accuracy.

Before executing the self-calibration procedure, disconnect all probes or wires from the input connector. Click  to call up the menu panel. Click the **Utility** softkey on panel, select **Function** in the bottom menu, the function menu will display at the left, select **Adjust**. If everything is ready, select **Self Cal** in the bottom menu to enter the self-calibration procedure of the instrument.

Probe checking

To check whether probe attenuation is good. The results contain three circumstances: Overflow compensation, Good compensation, Inadequate compensation. According to the checking result, users can adjust probe attenuation to the best. Operation steps are as follows:

1. Connect the probe to CH1, adjust the probe attenuation to the maximum.
2. Click  to call up the menu panel. Click the **Utility** softkey on panel, select **Function** in the bottom menu, select **Adjust** in the left menu.
3. Select **ProbeCh.** in the bottom menu, tips about probe checking shows on the screen.
4. Select **ProbeCh.** again to begin probe checking and the checking result will occur after 3s; push any other key to quit.

● Output

Click  to call up the menu panel. Click the **Utility** softkey on panel, select **Function** in the bottom menu, select **Output** in the left menu.

Output menu item in the bottom menu sets the output type of **Trig Out (P/F)** connector on *Side Panel*. In the bottom menu, select **Output**. The description of **Output menu** is shown as the follows:

Function Menu	Setting	Description
Output	TrigOut	Output trig signal synchronously
	Pass/fail	Output High Level when Pass, and Low Level when Fail

Device and **Print Set** menu items set the print output, refer to "*Print the Screen Image*" on page 94.

● LAN Set

Using the LAN port or Wi-Fi, the oscilloscope can be connected with a computer. The oscilloscope also supports communications with Android based smart device via Wi-Fi. Refer to "*Communication with PC*" on page 102 and "*Communication with Android Device via Wi-Fi (Optional)*" on page 110 for the operation steps.

- **Update**

Use the side panel USB port to update your instrument firmware using a USB memory device. Refer to "*Update your Instrument Firmware*" on page 69.

Set the Display System

Click  to call up the menu panel. Click the **Display** softkey on panel, the Display menu is shown as follows:

Function Menu	Setting		Description
Type	Dots Vect		Only the sampling points are displayed. The space between the adjacent sampling points in the display is filled with the vector form.
Persist & Color	Persist	OFF 1 Second 2 Seconds 5 Seconds Infinity	Set the persistence time
	Color	ON OFF	Turn on/off the color temperature function
Counter	ON OFF		Turn on/off counter
Clear			Erase the results of previous acquisitions from the display. The oscilloscope will start to accumulate acquisitions again.

Persist

When the **Persist** function is used, the persistence display effect of the picture tube oscilloscope can be simulated. The reserved original data is displayed in fade color and the new data is in bright color.

- (1) Click  to call up the menu panel. Click the **Display** softkey on panel.
- (2) Select **Persist&Color** in the bottom menu.
- (3) Select **Persist** in the right menu.
- (4) In the Time menu, select the persist time, including **OFF**, **1 Second**, **2**

Seconds, 5 Seconds and **Infinity**. When the "**Infinity**" option is set for Persist Time, the measuring points will be stored till the controlling value is changed. Select **OFF** to turn off persistence and clear the display.

- (5) Select **Clear** in the bottom menu to erase the results of previous acquisitions from the display. The oscilloscope will start to accumulate acquisitions again.

Color

Color temperature function uses color-grading to indicate frequency of occurrence. The hot colors like red/yellow indicate frequently occurring events, and the colder colors like blue/green indicate rarely occurring events.

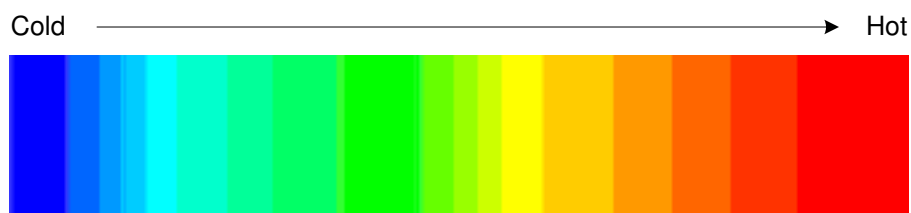

- (1) Click  to call up the menu panel. Click the **Display** softkey on panel.
- (2) Select **Persist&Color** in the bottom menu.
- (3) Select **Color** in the right menu, choose between **ON/OFF**.

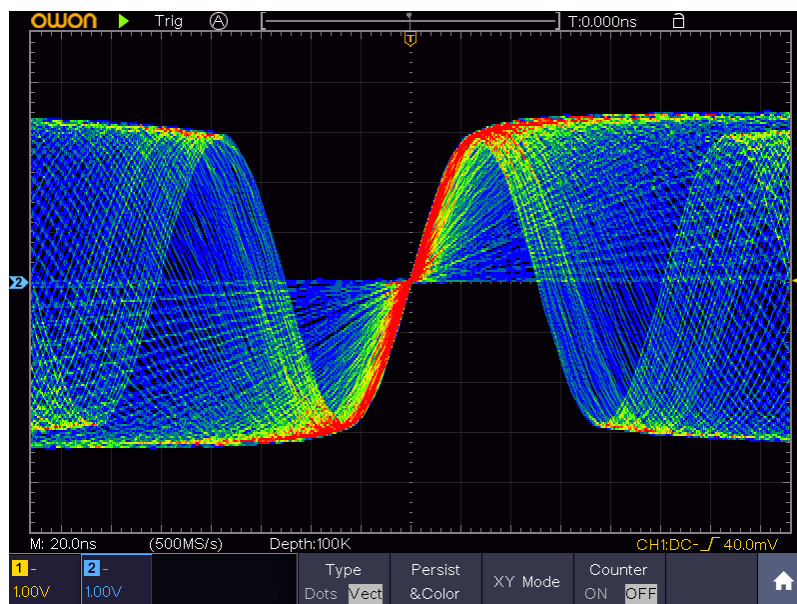

Figure 4-6 The color temperature function is on



Counter

It is a 6-digit single-channel counter. The counter can only measure the frequency of the triggering channel. The frequency range is from 2Hz to the full

bandwidth. Only if the measured channel is in **Edge** mode of **Single** trigger type, the counter can be enabled. The counter is displayed at the right bottom of the screen.



Operation steps:

1. Click , click the **Trig Menu** softkey on panel, set the trigger type to **Single**, set the trigger mode to **Edge**, select the signal source.
2. Click , click the **Display** softkey on panel.
3. Select **Counter** as **ON** or **OFF** in the bottom menu.

Save and Recall a Waveform

Click  to call up the menu panel. Click the **Save** softkey on panel, you can save the waveforms, configures, screen images, record or clone the waveform.

The description of the **Save Function Menu** is shown as the following table:

Function Menu	Setting	Description
Type	Wave Configure Image Record Clone	Choose the saving type. About the Record type, see " <i>Record/Playback Waveforms</i> " on P62. About the Clone type, see " <i>Clone and Recall a waveform</i> " on P66.
When the type is Wave , the menu shows as following:		
Type Wave	Format (Right menu)	For internal storage, only BIN can be selected. For external storage, the format can be BIN, TXT or CSV.
Source	CH1 CH2 Math (or MathFFT)	Check the waveform to be saved. (If certain channel is off, the corresponding menu item will be disabled.)
Object & Show	Object	Wave0 to Wave99
		Choose the address which the waveform is saved to or recall from.

	Show	ON OFF	Recall or close the waveform stored in the current object address. When the show is ON, if the current object address has been used, the stored waveform will be shown, the address number and relevant information will be displayed at the top left of the screen; if the address is empty, it will prompt "None is saved".
	Close All		Close all the waveforms stored in the object address.
Save			Save the waveform of the source to the selected address. Whatever the Type of save menu is set, you can save the waveform by just pressing the Copy panel button in any user interface. Select Type in the bottom menu, in the right Format menu, you can select the storage format.
Storage		Internal External	Save to internal storage or USB storage. When External is selected, save the waveform according to the current record length (see " <i>Record Length menu</i> " on P49); the file name is editable. The BIN waveform file could be open by OWON waveform analysis software (on the supplied CD).
When the type is Configure , the menu shows as following:			
Configure		Setting0 Setting19	The setting address
Save			Save the current oscilloscope configure to the internal storage
Load			Recall the configure from the selected address
When the type is Image , the menu shows as following:			
Save			Save the current display screen. The file can be only stored in a USB storage, so a USB storage must be connected first. The file name is editable. The file is stored in BMP format.



Save and Recall the Waveform

The oscilloscope can store 100 waveforms, which can be displayed with the current waveform at the same time. The stored waveform called out cannot be adjusted.

In order to save the waveform of CH1, CH2 and Math into the address 1, the operation steps should be followed:

1. Turn on CH1, CH2 and Math channels.
2. Click  to call up the menu panel. Click the **Save** softkey on panel.
3. **Saving**: Select **Type** in the bottom menu, select **Wave** in the left menu.
4. Select **Storage** in the bottom menu, select **Internal** in the right menu.
5. Select **Source** in the bottom menu, check **CH1**, **CH2**, **Math** in the right menu for Source.
6. Select **Object & Show** in the bottom menu, select **Wave1** as object address in the left menu.
7. Select **Save** in the bottom menu to save the waveform.
8. **Recalling**: Select **Object & Show** in the bottom menu, select **Wave1** in the left menu. In the right menu, select **Show** as **ON**, the waveform stored in the address will be shown, the address number and relevant information will be displayed at the top left of the screen.

In order to save the waveform of CH1 and CH2 into the USB storage as a BIN file, the operation steps should be followed:

1. Turn on CH1 and CH2 channels.
2. Click  to call up the menu panel. Click the **Save** softkey on panel.
3. **Saving**: Select **Type** in the bottom menu, select **Wave** in the left menu.
4. Select **Storage** in the bottom menu, select **External** in the right menu.
5. Select **Type** in the bottom menu, select **BIN** in the right menu as the storage format.
6. Select **Source** in the bottom menu, check **CH1**, **CH2** in the right menu for Source.
7. Select **Save** in the bottom menu, an input keyboard used to edit the file name will pop up. The default name is current system date and time. Select the  key in the keyboard to confirm.
8. **Recalling**: The BIN waveform file could be open by OWON waveform analysis software (on the supplied CD).

Tip:

Whatever the **Type** of save menu is set, you can save the waveform by just pressing the **Copy** panel button in any user interface. If the **Storage** of the save menu is set as "**External**", you should install the USB disk. Please refer to the contents below to install the USB disk and name the file to be saved.

Save the current screen image:

The screen image can only be stored in USB disk, so you should connect a USB disk with the instrument.

1. **Install the USB disk:** Insert the USB disk into the "**USB Host port**" of "*Figure 3-2 Side Panel*". If an icon  appears on the top right of the screen, the USB disk is installed successfully. If the USB disk cannot be recognized, format the USB disk according to the methods in "*USB disk Requirements*" on P58.
2. After the USB disk is installed, click  to call up the menu panel. Click the **Save** softkey on panel, the save menu is displayed at the bottom of the screen.
3. Select **Type** in the bottom menu, select **Image** in the left menu.
4. Select **Save** in the bottom menu, an input keyboard used to edit the file name will pop up. The default name is current system date and time. Select the  key in the keyboard to confirm.

USB disk Requirements

The supported format of the USB disk: FAT32 file system, the allocation unit size cannot exceed 4K, mass storage USB disk is also supported. If the USB disk doesn't work properly, format it into the supported format and try again. Follow any of the following two methods to format the USB disk: using system-provided function and using the formatting tools. (The USB disk of 8 G or 8 G above can only be formatted using the second method – using the formatting tools.)

Use system-provided function to format the USB disk

1. Connect the USB disk to the computer.
2. Right click **Computer**-> **Manage** to enter Computer Management interface.
3. Click Disk Management menu, and information about the USB disk will display on the right side with red mark 1 and 2.

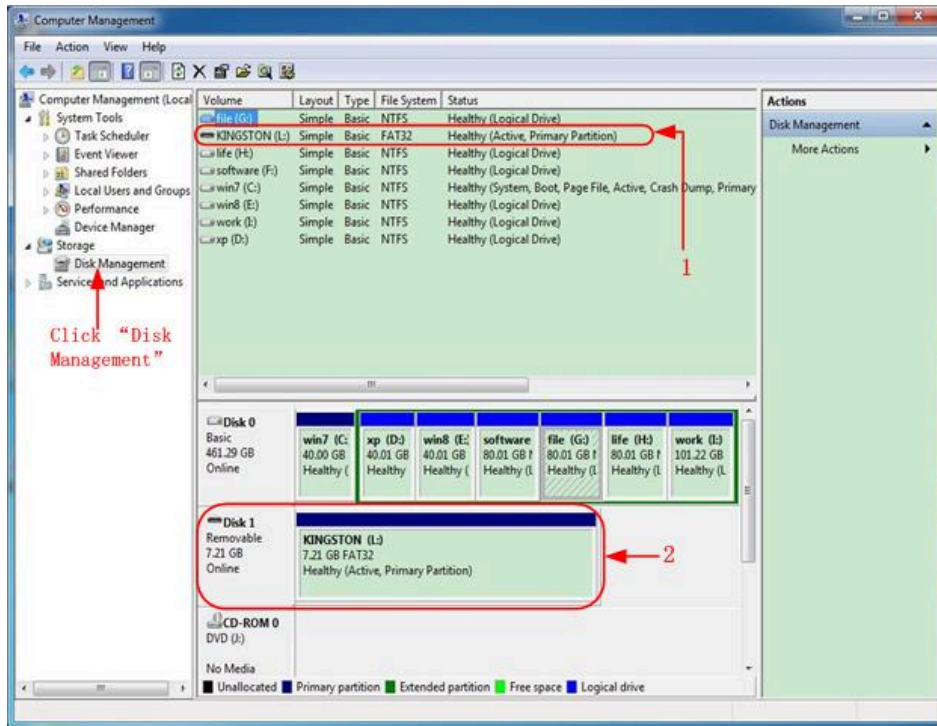

Figure 4-7: Disk Management of computer

4. Right click 1 or 2 red mark area, choose **Format**. And system will pop up a warning message, click **Yes**.

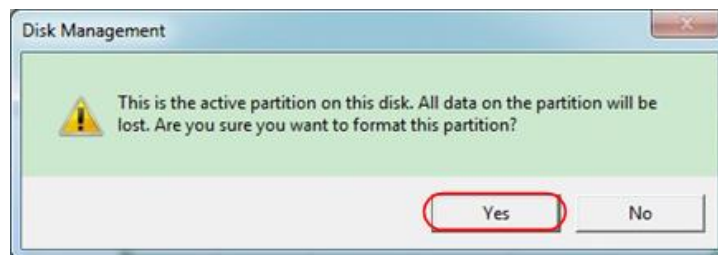

Figure 4-8: Format the USB disk warning

5. Set File System as FAT32, Allocation unit size 4096. Check "**Perform a quick format**" to execute a quick format. Click **OK**, and then click **Yes** on the warning message.

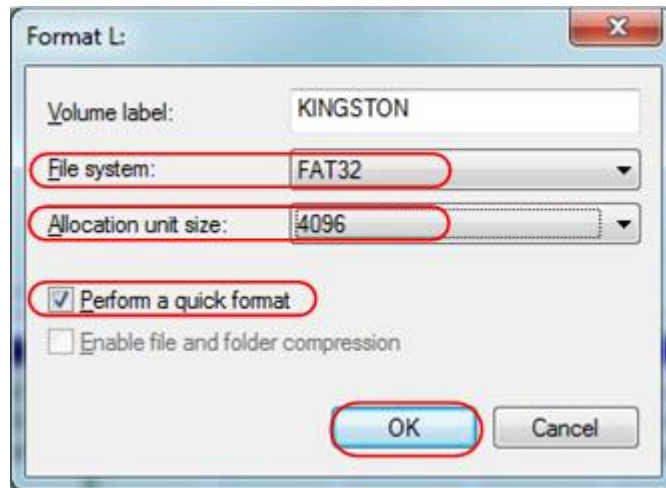

Figure 4-9: Formatting the USB disk setting

6. Formatting process.

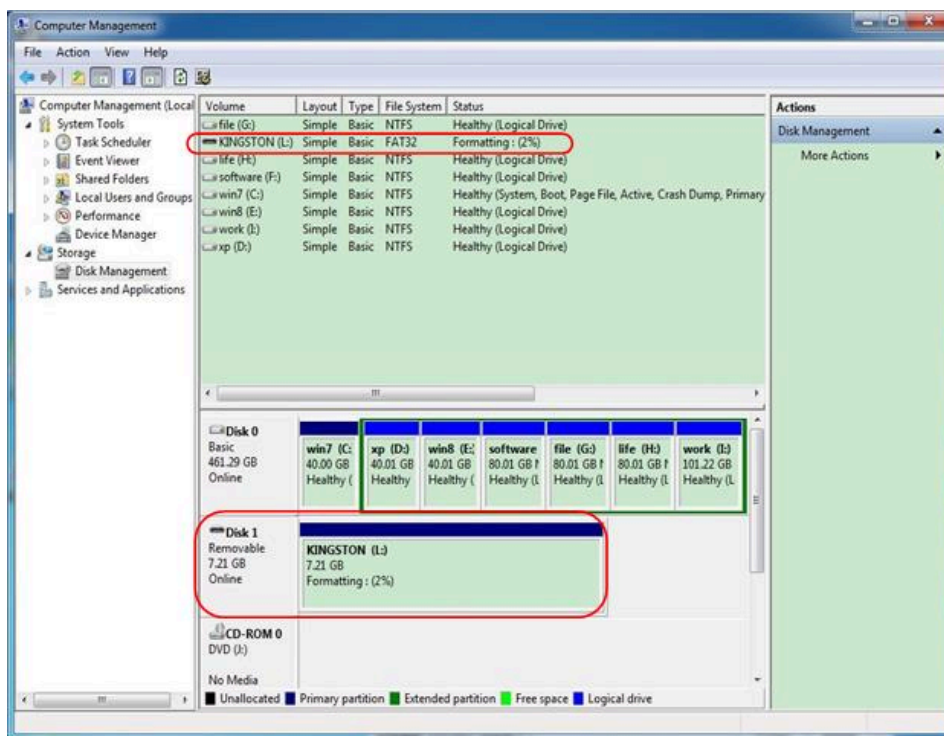

Figure 4-10: Formatting the USB disk

7. Check whether the USB disk is FAT32 with allocation unit size 4096 after formatting.

Use Minitool Partition Wizard to format

Download URL: <http://www.partitionwizard.com/free-partition-manager.html>

Tip: There are many tools for the USB disk formatting on the market, just take Minitool Partition Wizard for example here.

1. Connect the USB disk to the computer.
2. Open the software **Minitool Partition Wizard**.

- Click **Reload Disk** on the pull-down menu at the top left or push keyboard F5, and information about the USB disk will display on the right side with red mark 1 and 2.

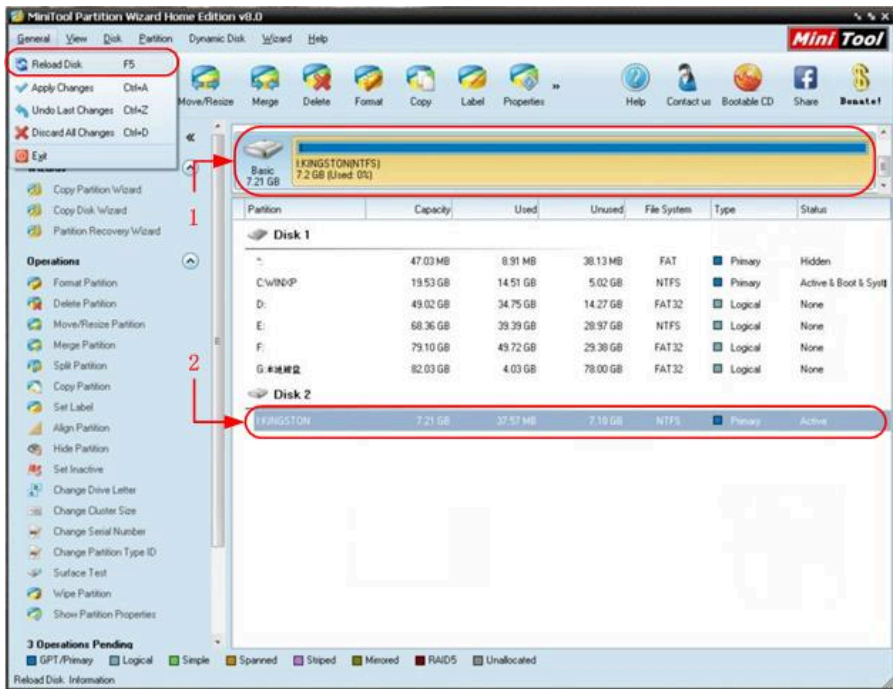

Figure 4-11: Reload Disk

- Right click 1 or 2 red mark area, choose **Format**.

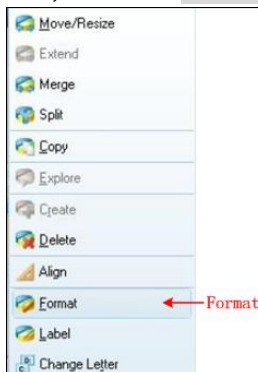

Figure 4-12: Choose format

- Set File System FAT32, Cluster size 4096. Click **OK**.

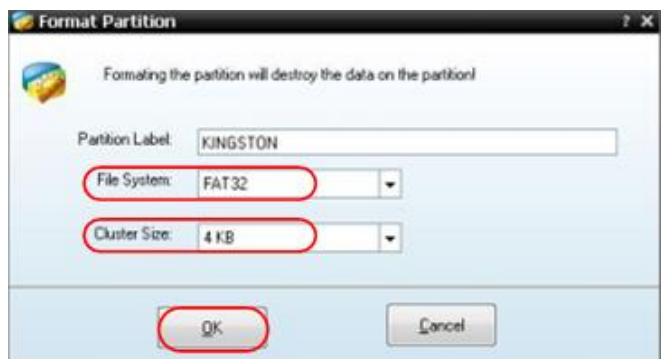

Figure 4-13: Format setting

6. Click **Apply** at the top left of the menu. Then click **Yes** on the pop-up warning to begin formatting.



Figure 4-14: Apply setting

7. Formatting process



Figure 4-15: Format process

8. Format the USB disk successfully



Figure 4-16: Format successfully

Record/Playback Waveforms

Click  to call up the menu panel. Click the **Save** softkey on panel. Select **Type** in the bottom menu, select **Record** in the left menu.

Wave Record function can record the input current wave. You can set the interval between recorded frames in the range of 10 ms - 10 s. The max frame number reaches 1000, and you can get better analysis effect with playback

and storage function. The storage medium contains two kinds: Internal and External.

When the storage medium is Internal, Wave Record contains four modes: **OFF**, **Record**, **Playback** and **Storage**.

When storage medium is External, Wave Record contains two modes: **OFF**, **Record**.

Record: To record wave according to the interval until it reaches the end frame set.

Record menu (Internal Storage) shows as follows:

Menu	Setting	Instruction
Mode	OFF	Close wave record function
	Record	Set record menu
	Playback	Set playback menu
	Storage	Set storage menu
Record mode FrameSet	End frame	Click + or - to select the number of frames to record (1 - 1000)
	Interval	Click + or - to select the interval between recorded frames (10ms - 10s)
Refresh	ON	Refresh wave during recording
	OFF	Stop refreshing
Operate	Play	Begin to record
	Stop	Stop recording

Note:

Both of the waveforms of Channel 1 and Channel 2 will be recorded. If a Channel is turned off while recording, the waveform of the channel is invalid in the playback mode.

Playback: Play back the wave recorded or saved.

Playback menu shows as follows:

Menu	Setting	Instruction
Playback mode FrameSet	Start frame	Click + or - to select the number of start frame to playback (1 - 1000)
	End frame	Click + or - to select the number of end frame to playback (1 - 1000)
	Cur frame	Click + or - to select the number of current frame to playback (1 - 1000)
	Interval	Click + or - to select the interval between played back frames (10ms - 10s)
Play mode	Loop	Play back the wave continuously
	Once	Play back the wave just one time

Operate	Play Stop	Begin to record Stop recording
---------	--------------	-----------------------------------

Storage: Save the current wave according to the start frame and end frame set.

Storage menu shows as follows:

Menu	Setting	Instruction
Storage mode Frame Set	Start frame	Click + or - to select the number of start frame to store (1 - 1000)
	End frame	Click + or - to select the number of end frame to store (1 - 1000)
Save		Save the waveform record file to the internal memory
Load		Load the waveform record file from the memory

To use wave record function, do as follows:

- (1) Click **⏠** to call up the menu panel. Click the **Save** softkey on panel.
- (2) Select **Type** in the bottom menu, in the left menu, select **Record**.
- (3) Select **Mode** in the bottom menu, select **OFF** in the right menu.
- (4) In the bottom menu, select **Storage** as **Internal**.
- (5) Select **Mode** in the bottom menu, select **Record** in the right menu.
- (6) Select **FrameSet** in the bottom menu, set **End frame** and **Interval** in the right menu.
- (7) In the bottom menu, set **Refresh**.
- (8) In the bottom menu, select **Operate** as **Play**.
- (9) Select **Mode** in the bottom menu, select **Playback** in the right menu. Set **FrameSet** and **Playmode**, select **Operate** as **Play**.
- (10) To save the wave recorded, select **Mode** in the bottom menu, select **Storage** in the right menu. Select **FrameSet** in the bottom menu to set the range of frames to store, select **Save** in the bottom menu.
- (11) To load the waveform from the internal memory, select **Load** in the bottom menu, then enter the **Playback** of the **Mode** to analyze the wave.

Note: When playing the waveform, the sampling, trigger, or display function is not available.

When storage medium is External, Wave Record contains two modes: OFF, Record.

Record menu (External Storage) shows as follows:

Menu	Setting	Instruction
Mode	OFF Record	Close wave record function Set record menu
Record mode	End frame	Click + or - to select the number of frames to record (1 – 900,000)

FrameSet	Interval	Click + or - to select the interval between recorded frames (10ms - 10s)
	Infinity	Record infinitely until the storage medium is full
Refresh	ON	Refresh wave during recording
	OFF	Stop refreshing
Operate	Play	Begin to record
	Stop	Stop recording

Note:

Both of the waveforms of Channel 1 and Channel 2 will be recorded. If a Channel is turned off while recording, the waveform of the channel is invalid in the playback mode.

To use wave record to external, do as follows:

1. Click **🏠** to call up the menu panel. Click the **Save** softkey on panel.
2. Select **Type** in the bottom menu, in the left menu, select **Record**.
3. Select **Mode** in the bottom menu, select **OFF** in the right menu.
4. In the bottom menu, select **Storage** as **External**.
5. Select **Mode** in the bottom menu, select **Record** in the right menu.
6. Select **FrameSet** in the bottom menu, set **End frame** and **Interval** in the right menu. If you want to record wave to external infinitely, select **Infinity** in the right menu, the End frame will display “-”.
7. In the bottom menu, set **Refresh**.
8. In the bottom menu, select **Operate** as **Play**.

Connect external device to the computer, and *wave_record_0.bin* is the recorded file. Open the software, and do as follows to play back the waveform.

1. Choose **Communications** → **Auto Player**.
2. Transform recording waveform from machine.
3. Add the well transformed files.
4. Set play mode and time delay.
5. Click the green button on the left corner to begin playing back the waveform.

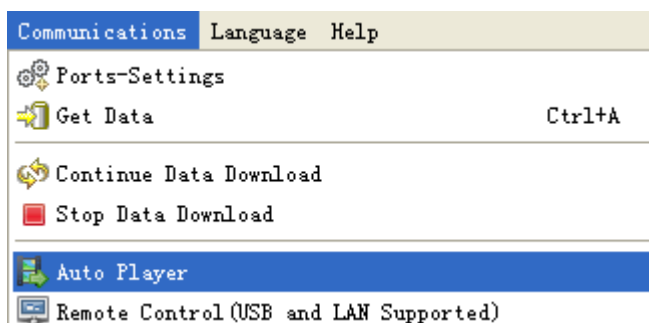

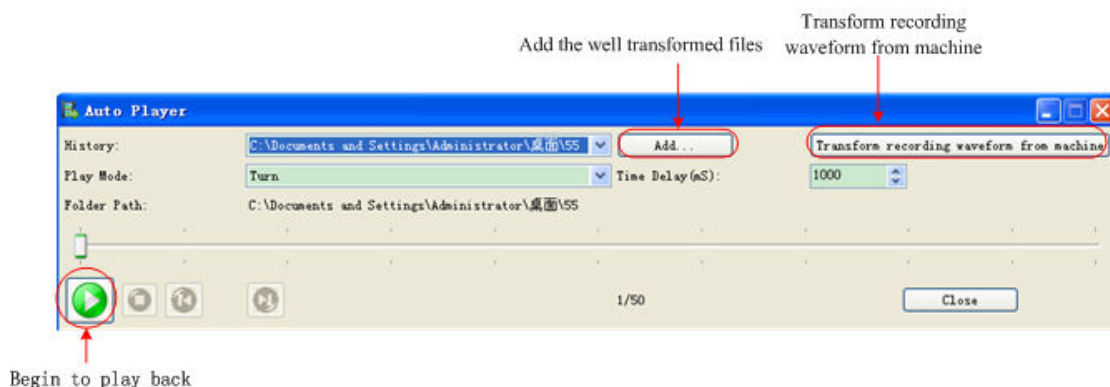

Figure 4-17: Play back waveform by software

Clone and Recall a waveform



Click to call up the menu panel. Click the **Save** softkey on panel. Select **Type** in the bottom menu, select **Clone** in the left menu.

You can clone one or two channel waveforms between two cursors, and save it as a cloned waveform into a USB memory device. The cloned waveform files saved to a USB memory device are saved with the extension ".ota".



You can also use OWON signal generator to read *.ota files and recall the cloned waveforms.

Clone Wave menu shows as follows:

Menu	Setting	Instruction
Type	Clone	Select the clone function.
Source	Mode	Select the source mode.
	Out1	The cloned waveform includes one waveform, which will be used for AG Out1
	Out2	The cloned waveform includes one waveform, which will be used for AG Out2
	Out1&Out2	The cloned waveform includes two waveforms, which will be used for AG Out1 and AG Out2
	AG Output Out1 CH1 CH2	Select the source, which will be used for AG Out1
	AG Output Out2 CH1 CH2	Select the source, which will be used for AG Out2

Line	<p>a b ab x</p>	<p>Click line a to select it, swipe left/right to move it. Click line b to select it, swipe left/right to move it. Two cursors are linked. Click line a or b to select them, swipe left/right to move the pair of cursors. Set the cursors to select the entire screen automatically.</p> <p>The waveform information is displayed at the left bottom corner of the screen.</p>  <p>Note: If "Out Of Limits" appears in the information or a message "Waveform points beyond the limit." appears on the screen, that means the length of the cloned waveform exceeds the limit. When the source mode is Out1 or Out2, the maximum length is 2M; When the source mode is Out1&Out2, the maximum length is 1M. Click  to call up the menu panel. Click the Acquire softkey on panel, select Length in the bottom menu, and set the record length to a smaller value.</p>
Save	<p>Save the waveform between two cursors onto a USB memory device. Insert a USB memory device into the port on the side panel. If the icon  appears on the top right of the screen, the USB memory device is installed successfully. If the USB memory device cannot be recognized, format the USB memory device according to the methods in "<i>USB disk Requirements</i>" on P58. The name is default as current system date and time. The cloned waveform will be saved onto the USB memory device as an OTA file.</p>	

To save the CH1 waveform and save to the USB memory:

- (1) Click  to call up the menu panel. Click the **Save** softkey on panel.
- (2) Select **Type** in the bottom menu, select **Clone** in the left menu.
- (3) Select **Source** in the bottom menu, select **Mode** as **Out1** in the right menu.
- (4) Select **AG Output Out1** as **CH1** in the right menu.
- (5) Select **Line** in the bottom menu. If **a** or **b** is selected, swipe to move the cursor. If **ab** is selected, swipe to move the pair of cursors. If **x** is selected, the entire screen will be selected automatically.
- (6) Select **Save** in the bottom menu. An input keyboard used to edit the file name will pop up. Select the keys to input the file name, select the  key in the keyboard to confirm. The cloned waveform will be saved onto

the USB memory device as an OTA file.

Data format description of OTA waveform file

If the source mode is set to Out1 or Out2, OTA file consists of two parts: the file header and the channel data. If the source mode is set to Out1&Out2, OTA file consists of three parts: file header, the first channel data, and the second channel data. The file header represents the parameter of file data, which is expressed in "parameter name + value". Each parameter name is a case-sensitive string of 4 bytes. The parameter value is at least 4 bytes.

1.Format description of the file header:

1) HEAD

Parameter name	Meaning	Value	Comment
HEAD	Header size	4 bytes int	

2) TYPE

Parameter name	Meaning	Value	Comment
TYPE	Model	12 bytes char	

3) BYTE

Parameter name	Meaning	Value	Comment
BYTE	Data length in bit	4 bytes int	

4) SIZE

Parameter name	Meaning	Value	Comment
SIZE	File size	4 bytes int	Used to check the file integrity

5) VOLT

Parameter name	Meaning	Value	Comment
VOLT	Voltage division, divided by 400 is ADC resolution. (When the source mode is Out1&Out2, it is the first channel voltage division.)	4 bytes float	The value indicates voltage (the unit is mV), such as 200 mV.

6) SAMP

Parameter name	Meaning	Value	Comment
SAMP	Sample rate	4 bytes float	The unit is Sa/s.

7) ADCB

Parameter name	Meaning	Value	Comment
ADCB	ADC bit, ADC resolution	4 bytes int	8-bit or 12-bit

8) CHAN

Parameter name	Meaning	Value	Comment
CHAN	Number of channels	4 bytes int	1 or 2

9) VOL2

Parameter name	Meaning	Value	Comment
VOL2	Voltage division, divided by 400 is ADC resolution. (When the source mode is Out1&Out2, it is the second channel voltage division.)	4 bytes float	The value indicates voltage (the unit is mV), such as 200 mV.

2.Data

The data type is signed integer. You can determine the data type (**char**, **short int** or **int**) based on the BYTE parameter. The valid range is determined by the ADCB parameter, e.g. the valid range for 8-bit ADC is -127 to +127.

Update your Instrument Firmware



Use the side panel USB port to update your instrument firmware using a USB memory device.

USB memory device requirements: Insert a USB memory device into the

USB port on the side panel. If the icon  appears on the top right of the screen, the USB memory device is installed successfully. If the USB memory device cannot be detected, format the USB memory device according to the methods in "*USB disk Requirements*" on P58.

Caution: Updating your instrument firmware is a sensitive operation, to prevent damage to the instrument, do not power off the instrument or remove the USB memory device during the update process.

To update your instrument firmware, do the following:

1. Click  to call up the menu panel. Click the **Utility** softkey on panel, select **Function** in the bottom menu, select **Configure** in the left menu, select **About** in the bottom menu. View the model and the currently installed firmware version.
2. From a PC, visit www.owon.com and check if the website offers a newer firmware version. Download the firmware file. The file name must be *.update. The file name can be up to 15 characters long (including the suffix). Copy the firmware file onto your USB memory device.
3. Insert the USB memory device into the side panel USB port on your instrument.
4. Click  to call up the menu panel. Click the **Utility** softkey on panel, select **Function** in the bottom menu, select **Update** in the left menu.
5. Select **Open** in the bottom menu, the instrument lists a directory of the folders on the USB memory device. Turn the upper knob to select a folder, select **Open** in the bottom menu to enter the folder. Navigate to the folder where the firmware file is, and select the file with the .update suffix.
6. In the bottom menu, select **Open**, the messages below will be shown.

```
Do not power off the instrument.  
The internal data will be cleared.  
Press <start> to execute.  
Press any key to quit.
```

7. In the bottom menu, select **Start** again, the interfaces below will be displayed in sequence. The update process will take up to three minutes. After completion, the instrument will be shut down automatically.

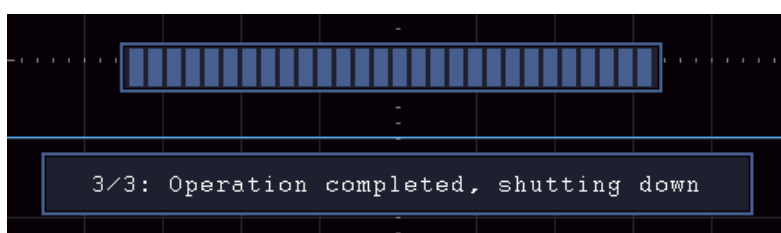
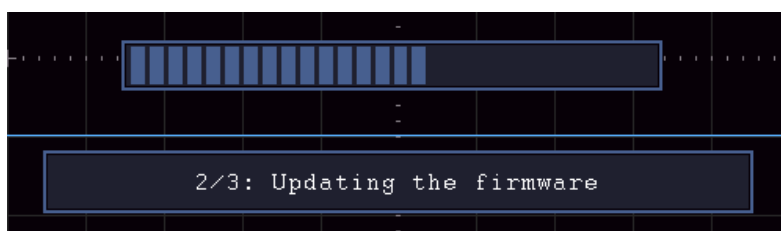
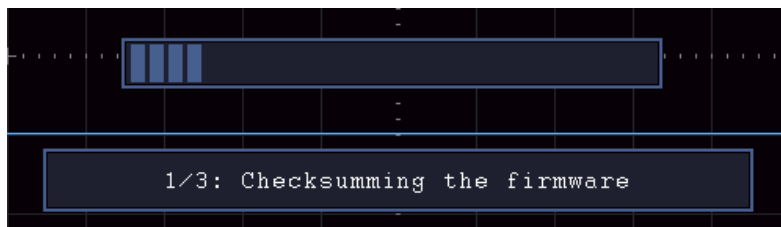

8. Long press the  button to power on the instrument.

Measure Automatically

Click  to call up the menu panel. Click the **Measure** softkey on panel to display the Measure menu. At most 8 types of measurements could be displayed on the bottom left of the screen.

The oscilloscopes provide 39 parameters for auto measurement, including Period, Frequency, Mean, PK-PK, RMS, Max, Min, Top, Base, Amplitude, Overshoot, Preshoot, Rise Time, Fall Time, +PulseWidth, -PulseWidth, +Duty Cycle, -Duty Cycle, Screen Duty, FRR, FRF, FFR, FFF, LRR, LRF, LFR, LFF, Delay A→B $\overline{\text{P}}$, Delay A→B $\overline{\text{N}}$, Cycle RMS, Cursor RMS, FRR, FRF, FFR, FFF, LRR, LRF, LFR, LFF, Phase A→B $\overline{\text{P}}$, Phase A→B $\overline{\text{N}}$, +PulseCount, -PulseCount, RiseEdgeCnt, FallEdgeCnt, Area, and Cycle Area.

The "Automatic Measurements" menu is described as the following table:

Function Menu		Description	
Add	Meas Type (left menu)	Select the measure types	
	Source CH1 CH2	Select the source	
	Add	Add the selected measure types (shown at the left bottom, you could only add 8 types at most)	
Remove	Meas Type (left menu)	Select the types need to be deleted. The selected type and source are shown in the Remove menu on the right.	
	Remove	Remove the selected measure type	
	Remove All	Remove all the measures	
Snapshot	ON OFF	Show all the measures of the snapshot source Turn off the snapshot	
Source	CH1 CH2	Select the snapshot source	
Set	Gating	Screen Cursor	Select "Screen" or "Cursor" to set the cursor range
	Statistics	ON OFF	select "ON" or "OFF" for measurement value statistics
	Reset		Restart statistics on statistics

Measure

Only if the waveform channel is in the ON state, the measurement can be performed. The automatic measurement cannot be performed in the following situation: 1) On the saved waveform. 2) On Waveform Math waveform. 3) On the Video trigger mode.

On the Scan format, period and frequency cannot be measured.

Measure the period, the frequency of the CH1, following the steps below:

1. Click  to call up the menu panel. Click the **Measure** softkey on panel to show the automatic measurement function menu.
2. Select **Add** in the bottom menu.
3. In the left Type menu, select **Period**.
4. In the right menu, select **Source** as **CH1**.
5. In the right menu, select **Add**. The period type is added.
6. In the left Type menu, select **Frequency**.
7. In the right menu, select **Source** as **CH1**.
8. In the right menu, select **Add**. The frequency type is added.

The measured value will be displayed at the bottom left of the screen automatically (see *Figure 4-18*).

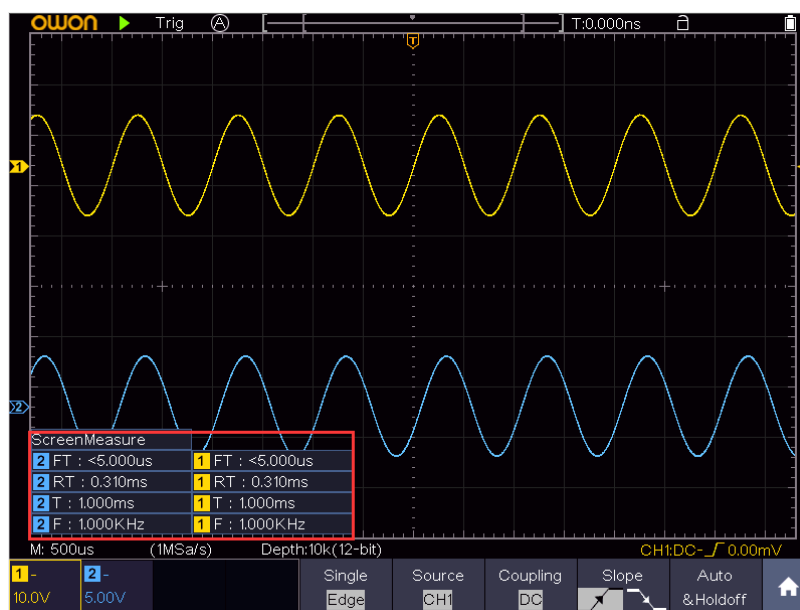

Figure 4-18 Automatic measurement

The automatic measurement of voltage parameters

The oscilloscopes provide automatic voltage measurements including Mean, PK-PK, RMS, Max, Min, Vtop, Vbase, Vamp, OverShoot, PreShoot, Cycle RMS, and Cursor RMS. *Figure 4-19* below shows a pulse with some of the voltage measurement points.

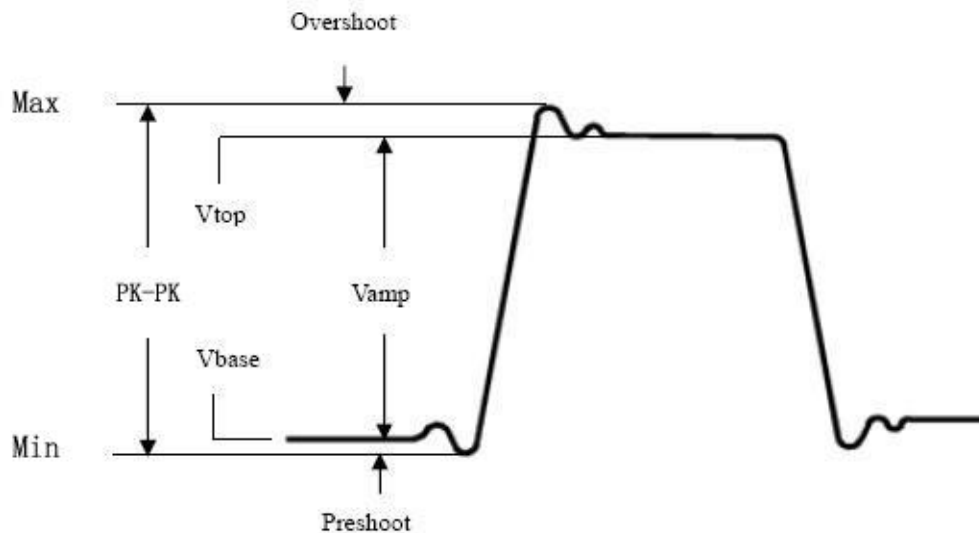

Figure 4-19

Mean: The arithmetic mean over the entire waveform.

PK-PK: Peak-to-Peak Voltage.

RMS: The true Root Mean Square voltage over the entire waveform.

Max: The maximum amplitude. The most positive peak voltage measured over the entire waveform.

Min: The minimum amplitude. The most negative peak voltage measured over the entire waveform.

Vtop: Voltage of the waveform's flat top, useful for square/pulse waveforms.

Vbase: Voltage of the waveform's flat base, useful for square/pulse waveforms.

Vamp: Voltage between Vtop and Vbase of a waveform.

OverShoot: Defined as $(V_{max}-V_{top})/V_{amp}$, useful for square and pulse waveforms.

PreShoot: Defined as $(V_{min}-V_{base})/V_{amp}$, useful for square and pulse waveforms.

Cycle RMS: The true Root Mean Square voltage over the first entire period of the waveform.

Cursor RMS: The true Root Mean Square voltage over the range of two cursors.

The automatic measurement of time parameters

The oscilloscopes provide time parameters auto-measurements include Period, Frequency, Rise Time, Fall Time, +D width, -D width, +Duty, -Duty, Delay A→B $\overleftrightarrow{\Psi}$, Delay A→B $\overleftarrow{\Psi}$, Screen Duty, Phase A→B $\overleftrightarrow{\Psi}$, and Phase A→B $\overleftarrow{\Psi}$, FRR, FRF, FFR, FFF, LRR, LRF, LFR, LFF.

Figure 4-20 shows a pulse with some of the time measurement points.

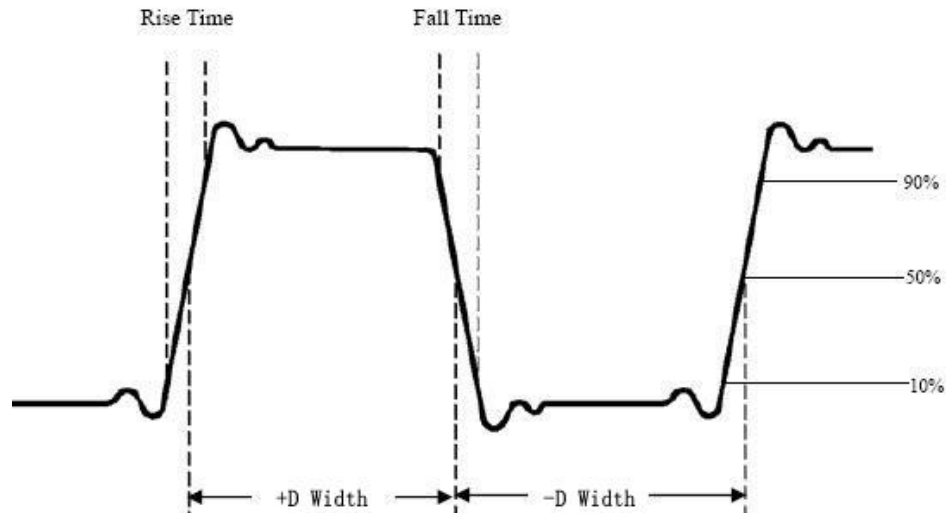

Figure 4-20

Rise Time: Time that the leading edge of the first pulse in the waveform takes to rise from 10% to 90% of its amplitude.

Fall Time: Time that the falling edge of the first pulse in the waveform takes to fall from 90% to 10% of its amplitude.

+D width: The width of the first positive pulse in 50% amplitude points.

-D width: The width of the first negative pulse in the 50% amplitude points.

+Duty: +Duty Cycle, defined as +Width/Period.

-Duty: -Duty Cycle, defined as -Width/Period.

Delay A→B ⚡: The delay between the two channels at the rising edge.

Delay A→B ⚡: The delay between the two channels at the falling edge.

Screen Duty: Defines as (the width of the positive pulse)/(Entire period)

Phase A→B ⚡: Phase difference calculated according to " Delay A→B ⚡ " and the period of source A, expressed in degree. The calculation formula is as shown below:

$$\text{Phase A} \rightarrow \text{B} \boldsymbol{\uparrow} = (\text{Delay A} \rightarrow \text{B} \boldsymbol{\uparrow} \div \text{Period of source A}) \times 360^\circ$$

Phase A→B ⚡: Phase difference calculated according to " Delay A→B ⚡ " and the period of source A, expressed in degree. The calculation formula is as shown below:

$$\text{Phase A} \rightarrow \text{B} \boldsymbol{\downarrow} = (\text{Delay A} \rightarrow \text{B} \boldsymbol{\downarrow} \div \text{Period of source A}) \times 360^\circ$$

Note for the following delay measurements:

Source A and Source B can be set in the automatic measurement function menu.

FRR: Time between Source A first rising edge and Source B first rising edge.

FRF: Time between Source A first rising edge and Source B first falling edge.

FFR: Time between Source A first falling edge and Source B first rising edge.

FFF: Time between Source A first falling edge and Source B first falling edge.

LRR: Time between Source A first rising edge and Source B last rising edge.

LRF: Time between Source A first rising edge and Source B last falling edge.

LFR: Time between Source A first falling edge and Source B last rising edge.

LFF: Time between Source A first falling edge and Source B last falling edge.

Other measurements

+PulseCount : The number of positive pulses that rise above the mid reference crossing in the waveform.

-PulseCount : The number of negative pulses that fall below the mid reference crossing in the waveform.

RiseEdgeCnt : The number of positive transitions from the low reference value to the high reference value in the waveform.

FallEdgeCnt : The number of negative transitions from the high reference value to the low reference value in the waveform.

Area : The area of the whole waveform within the screen and the unit is voltage-second. The area measured above the zero reference (namely the vertical offset) is positive; the area measured below the zero reference is negative. The area measured is the algebraic sum of the area of the whole waveform within the screen.

Cycle Area : The area of the first period of waveform on the screen and the unit is voltage-second. The area above the zero reference (namely the vertical offset) is positive and the area below the zero reference is negative. The area measured is the algebraic sum of the area of the whole period waveform.

Note: When the waveform on the screen is less than a period, the period area measured is 0.

Customize an Automatic Measurement

You can customize automatic measurements by using gating and statistics.

Gating

- Press the **Measure** button, and the automatic measurement function menu is displayed at the bottom of the screen;
- Press the **Set** softkey at the bottom of the screen, the setting menu appears on the right side of the screen;
- Select the **Gating** menu. There are two menus: **Screen** and **Cursor** under the range. Click the **Screen** and then click the **Cursor**, or press the right

Screen menu button twice to set the cursor range.

Statistics

Select **Statistics**, you can choose **On** or **Off** to enable or disable statistics on the measurement value.

Statistics reset: Restart statistics on statistics.

Measure with Cursors

Click  to call up the menu panel. Click the **Cursor** softkey on panel to switch to the **ON** state and display the cursor menu. Click it again to turn cursors off.

The Cursor Measurement for normal mode:

The description of the **cursor menu** is shown as the following table:

Function Menu	Setting	Description
Type	Voltage Time Time&Voltage AutoCursr	Display the voltage measurement cursor and menu. Display the time measurement cursor and menu. Display the time and voltage measurement cursor and menu. The horizontal cursors are set as the intersections of the vertical cursors and the waveform
Line Type (Time&Voltage type)	Time Voltage	Makes the vertical cursors active. Makes the horizontal cursors active.
Window (Wave zoom mode)	Main Extension	Measure in the main window. Measure in the extension window.
Source	CH1 or CH2	Display the channel to which the cursor measurement will be applied.

Perform the following operation steps for the time and voltage cursor measurement of the channel CH1:

1. Click  to call up the menu panel. Click the **Cursor** softkey on panel to switch to the **ON** state and display the cursor menu.
2. Select **Source** in the bottom menu, select **CH1** in the right menu.
3. Select the first menu item in the bottom menu, the **Type** menu will display at the right of the screen. In the right menu, select **Time&Voltage** for Type, two blue dotted lines displayed along the

horizontal direction of the screen, two blue dotted lines displayed along the vertical direction of the screen. Cursor measure window at the left bottom of the screen shows the cursor readout.

4. In the bottom menu, select **Line Type** as **Time** to make the vertical cursors active. Click line **a** to select it, swipe left/right to move it. Click line **b** to select it, swipe left/right to move it.
5. In the bottom menu, select **Line Type** as **Voltage** to make the horizontal cursors active. Click line **a** to select it, swipe up/down to move it. Click line **b** to select it, swipe up/down to move it.
6. Push the **Horizontal HOR** button to enter wave zoom mode. In the bottom cursor menu, select **Window** as **Main** or **Extension** to make the cursors shown in the main window or zoom window.

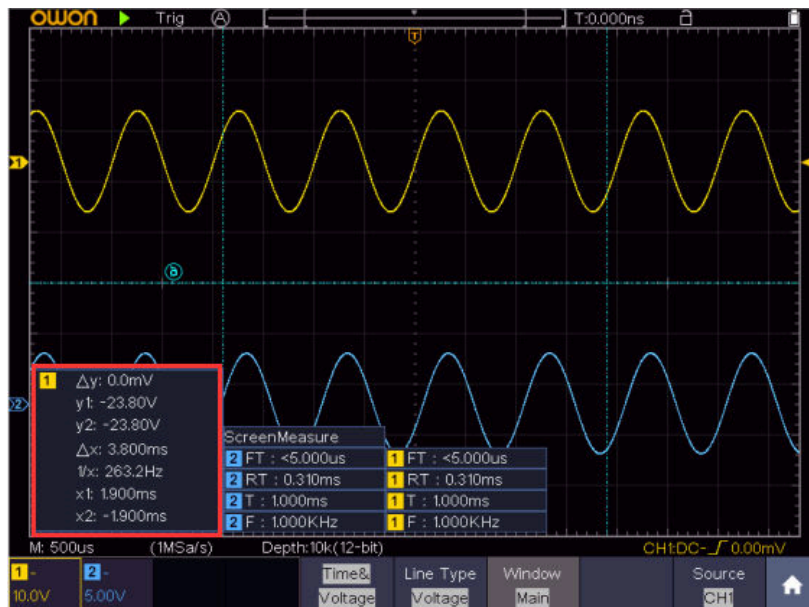

Figure 4-21 Time&Voltage Cursor Measurement

Auto Cursor

For the AutoCursr type, the horizontal cursors are set as the intersections of the vertical cursors and the waveform.

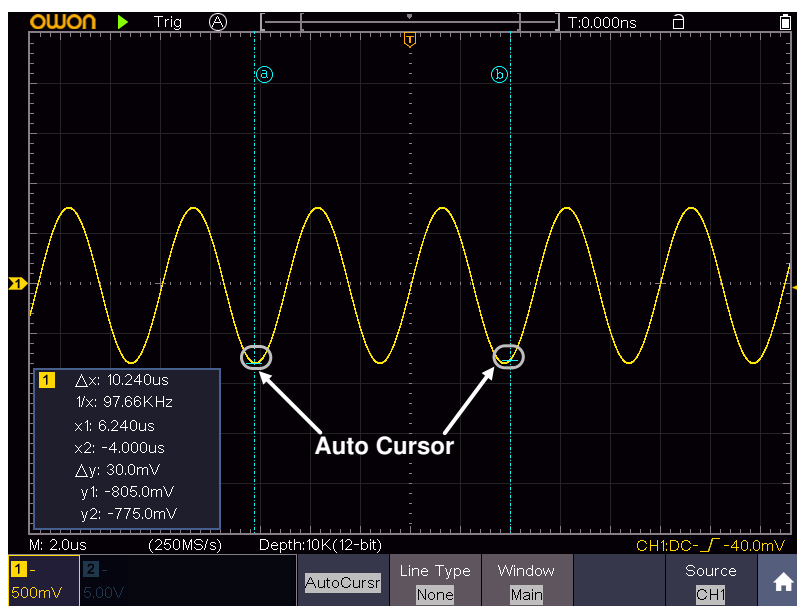



Figure 4-22 Auto Cursor



The Cursor Measurement for FFT mode

In FFT mode, click  to call up the menu panel. Click the **Cursor** softkey on panel to switch to the **ON** state and display the cursor menu.

The description of the **cursor menu** in FFT mode is shown as the following table:

Function Menu	Setting	Description
Type	Vamp (or Phase)	Display the Vamp (or Phase) measurement cursor and menu.
	Freq	Display the Freq measurement cursor and menu.
	Freq&Vamp (or Freq&Phase)	Display the corresponding measurement cursor and menu.
	AutoCursr	The horizontal cursors are set as the intersections of the vertical cursors and the waveform
Line Type (Freq&Vamp or Freq&Phase type)	Freq	Makes the vertical cursors active.
	Vamp (or Phase)	Makes the horizontal cursors active.
Window (Wave zoom mode)	Main Extension	Measure in the main window. Measure in the FFT extension window.
Source	Math FFT	Display the channel to which the cursor measurement will be applied.

Perform the following operation steps for the amplitude and frequency cursor measurement of math FFT:

1. Click  to call up the menu panel. Click the **FFT** softkey on panel to switch to the **ON** state and display the FFT menu. In the bottom menu, select **Format**. In the right menu, select amplitude unit (**V RMS** or **Decibels**).
2. Click  to call up the menu panel. Click the **Cursor** softkey on panel to switch to the **ON** state and display the cursor menu.
3. In the bottom menu, select **Window** as **Extension**.
4. Select the first menu item in the bottom menu, the **Type** menu will display at the right of the screen. In the right menu, select **Freq&Vamp** for Type, two blue dotted lines displayed along the horizontal direction of the screen, two blue dotted lines displayed along the vertical direction of the screen. Cursor measure window at the left bottom of the screen shows the cursor readout.
5. In the bottom menu, select **Line Type** as **Freq** to make the vertical cursors active. Click line **a** to select it, swipe left/right to move it. Click line **b** to select it, swipe left/right to move it.
6. In the bottom menu, select **Line Type** as **Vamp** to make the horizontal cursors active. Click line **a** to select it, swipe up/down to move it. Click line **b** to select it, swipe up/down to move it.
7. In the bottom cursor menu, you can select **Window** as **Main** to make the cursors shown in the main window.

Use Mathematical Manipulation Function

The **Mathematical Manipulation** function is used to show the results of the addition, multiplication, division and subtraction operations between two channels, advanced math feature including Intg, Diff, Sqrt, user defined function, and digital filter. Click  to call up the menu panel. Click the **Math** softkey on panel to switch to the **ON** state and display the math menu on the bottom.

The Waveform Calculation menu:

Function Menu		Setting	Description
Waveform Math	Factor1	CH1 CH2	Select the signal source of the factor1
	Sign	+ - * /	Select the sign of mathematical manipulation
	Factor2	CH1 CH2	Select the signal source of the factor2

	Vertical (div)	Click + or - to adjust the vertical position of the Math waveform		
	Vertical (V/div)	Click + or - to adjust the vertical division of the Math waveform		
User Function	Edit fun	Intg, Diff, Sqrt, and user defined function		
	Vertical (div)	Click + or - to adjust the vertical position of the Math waveform		
	Vertical (V/div)	Click + or - to adjust the vertical division of the Math waveform		
DIR	channel	CH1 CH2	Select channel	
	type	low-pass	Only the signals whose frequencies are lower than the current cut-off frequency can pass the filter.	
		high-pass	Only the signals whose frequencies are greater than the current cutoff frequency can pass the filter.	
		band-pass	Only the signals whose frequencies are greater than the cutoff frequency down and lower than the current cutoff frequency upper can pass the filter.	
		band-reject	Only the signals whose frequencies are lower than the current cutoff frequency down or greater than the current cutoff frequency upper can pass the filter.	
	window	Retangular Tapered Triangular Hanning Hamming Blackman	Select window for digital filter	
	cut-off fre or upper down	Click + or - to set cut-off frequency		
	Vertical (div)	Click + or - to adjust the vertical position of Math waveform		

Waveform math

Taking the additive operation between Channel 1 and Channels 2 for example, the operation steps are as follows:

1. Click  to call up the menu panel. Click the **Math** softkey on panel to switch to the **ON** state and display the math menu on the bottom. The pink M

waveform appears on the screen.

2. Select **Waveform Math** in the bottom menu.
3. In the right menu, select **Factor1** as **CH1**.
4. Select **Sign** as **+** in the right menu.
5. In the right menu, select **Factor2** as **CH2**.
6. Select **Vertical (div)** in the right menu, click **+** or **-** to adjust the vertical position of Math waveform.
7. Select **Vertical (V/div)** in the right menu, click **+** or **-** to adjust the vertical division of Math waveform.

User defined function

1. Click the **Math** softkey on panel to switch to the **ON** state and display the math menu on the bottom.
2. Select **User Function** in the bottom menu, select **Edit fun** in the right menu, an expression input keyboard pops up.

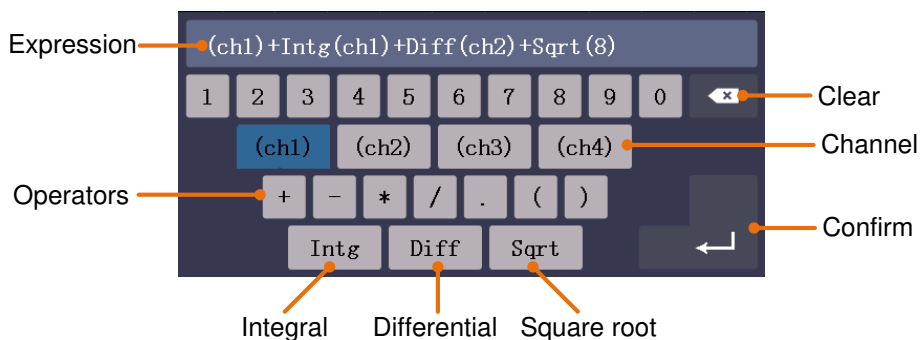

3. Create an expression. When done, choose **Confirm** in the keyboard to confirm. The division of Math waveform is displayed at the left bottom of screen.



Digital Filter

Digital filter provides 4 types of filters (low pass, high pass, band pass and band reject). The specified frequencies can be filtered by setting the cut-off frequency. Digital filter can only apply to CH1 or CH2.

1. Click the **Math** softkey on panel to switch to the **ON** state and display the math menu on the bottom.
2. Select **DIR** in the bottom menu.
3. In the right menu, select **channel** as **CH1** or **CH2**.





4. In the right menu, select **type**, select the desired filter type.
5. In the right menu, select **window**, select the desired window.
6. When **low-pass** or **high-pass** type is selected, select **cut-off fre** in the right menu.
When **band-pass** or **band-reject** type is selected, select **upper** or **down** in the right menu. Click **+** or **-** to adjust the frequency.
7. In the right menu, select **Vertical (div)**, click **+** or **-** to adjust the vertical position of Math waveform. The voltage division of Math waveform is the same as the selected channel.

Note: On the Scan format, digital filter is disabled.



Use Autoscale function

This is a very useful function for first time users to carry out a simple and quick test on the input signal. The function is applied to follow-up signals automatically even if the signals change at any time. Autoscale enables the instrument to set up trigger mode, voltage division and time scale automatically according to the type, amplitude and frequency of the signals.

The menu is as follows:

Function Menu	Setting	Instruction
Mode		Follow-up and adjust both vertical and horizontal settings.
		Follow-up and only adjust horizontal scale.
		Follow-up and only adjust vertical scale.
Wave		Show Multi-period waveforms.
		Only show one or two periods.

To measure the signal using autoscale, you can do as the follows:

1. Click  to call up the menu panel. Click the **Autoscale** softkey on panel to switch to the **ON** state. The function menu will appear.
2. In the bottom menu, Select **Mode**. In the right menu, select .
3. In the bottom menu, Select **Wave**. In the right menu, select .

Then the wave is displayed in the screen, shown as *Figure 4-23*.

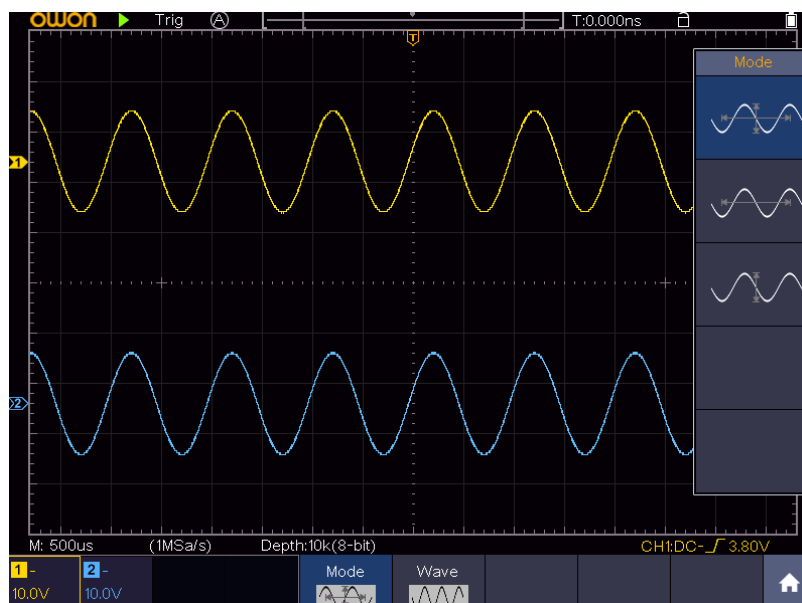



Figure 4-23 Autoscale Horizontal-Vertical multi-period waveforms

Note:

1. When entering into Autoscale function, a autoscale indicator will be flickering on the top left of the screen.
2. In the mode of Autoscale, the oscilloscope can self-estimate Trigger Mode (Edge, Video). At this point, the trigger menu is not available.
3. When the input signal contains the DC component, the coupling will be set to AC, the amplitude of the input signal should be greater than 5mV, and the frequency should be greater than 20Hz.
4. At the mode of Autoscale, DSO is always set as DC coupling with AUTO triggering, the holdoff is set to 100ns.
5. At the mode of Autoscale, if adjust the vertical position, voltage division, trigger level or time scale, the oscilloscope will pause the Autoscale function. To resume Autoscale, push the **Autoset** front panel button.
6. When video triggering, the horizontal time scale is 50us.
7. While the Autoscale is working, the settings below will be made forcibly:
The DSO will switch from the wave zoom mode to the normal mode.
In the decoding, pass/fail or XY mode, when entering into Autoscale, these modes will be turned off.
In the STOP status, when entering into Autoscale, the status will be set to RUN.

Use HOR function

Click  to call up the menu panel. Click the **HOR** softkey on panel to switch to the **ON** or **OFF** state. You can quickly enter the waveform horizontal zoom mode, waveform zoom mode.

Use FFT function

FFT refers to the Fourier transform operation on a certain channel.

The FFT menu:

Function Menu		Setting	Description
Source		CH1 CH2	Select the FFT source.
Window		Hamming Rectangle Blackman Hanning Kaiser Bartlett	Select window for FFT.
Format		V RMS Decibels Radian Degrees	V RMS and Decibels are amplitude units; Radian, Degrees are phase units.
Display	Hori (Hz)	Position value Time base value/	Switch to select the horizontal position or time base of the FFT waveform, click + or - to adjust it.
	Vertical	Position value Division value/	Switch to select the vertical position or voltage division of the FFT waveform, click + or - to adjust it.
FFT Peak	ON OFF		Enable or disable FFT peak search. Dynamic marker ∇ marks the FFT peak.

The FFT (fast Fourier transform) math function mathematically converts a time-domain waveform into its frequency components. It is very useful for analyzing the input signal on Oscilloscope. You can match these frequencies with known system frequencies, such as system clocks, oscillators, or power supplies.

FFT function in this oscilloscope transforms 8192 data points of the time-domain signal into its frequency components mathematically (the record length should be 10K or above). The final frequency contains 4096 points ranging from 0Hz to Nyquist frequency.



Taking the FFT operation for example, the operation steps are as follows:

1. Click  to call up the menu panel. Click the **FFT** softkey on panel to switch to the **ON** state and display the FFT menu on the bottom. The pink M waveform appears on the screen.
2. In the bottom menu, select **Source**. In the right menu, select **CH1**.
3. In the bottom menu, select **Window**. In the right menu, select the proper window type.

4. In the bottom menu, select **Format**. In the right menu, select amplitude unit (**V RMS, Decibels**) or phase unit (**Radian, Degrees**).
5. In the bottom menu, select **Display**. In the right menu, select **Hori (Hz)**; select repeatedly to make the **M** symbol in front of the horizontal position value (the upper one), click **+** or **-** to adjust the horizontal position of FFT waveform; then select to make the **M** symbol in front of the time base value below, click **+** or **-** to adjust the time base of FFT waveform.
6. Select **Vertical** in the right menu; do the same operations as above to set the vertical position and vertical division.

To select the FFT window

■ There are 6 FFT windows. Each one has trade-offs between frequency resolution and magnitude accuracy. What you want to measure and your source signal characteristics help you to determine which window to use. Use the following guidelines to select the best window.

Type	Characteristics	Window
Hamming	<p>Better solution for magnitude than Rectangle, and good for frequency as well. It has slightly better frequency resolution than Hanning.</p> <p>Recommend to use for:</p> <ul style="list-style-type: none"> ● Sine, periodic and narrow band random noise. ● Transients or bursts where the signal levels before and after the event are significantly different. 	
Rectangle	<p>Best solution for frequency, worst for magnitude.</p> <p>Best type for measuring the frequency spectrum of nonrepetitive signals and measuring frequency components near DC.</p> <p>Recommend to use for:</p> <ul style="list-style-type: none"> ● Transients or bursts, the signal level before and after the event are nearly equal. ● Equal-amplitude sine waves with frequencies those are very close. ● Broadband random noise with a relatively slow varying spectrum. 	



Blackman	<p>Best solution for magnitude, worst for frequency.</p> <p>Recommend to use for:</p> <ul style="list-style-type: none"> ● Single frequency waveforms, to find higher order harmonics. 	
Hanning	<p>Good for magnitude, but poorer frequency resolution than Hamming.</p> <p>Recommend to use for:</p> <ul style="list-style-type: none"> ● Sine, periodic and narrow band random noise. ● Transients or bursts where the signal levels before and after the event are significantly different. 	
Kaiser	<p>The frequency resolution when using the Kaiser window is fair; the spectral leakage and amplitude accuracy are both good.</p> <p>The Kaiser window is best used when frequencies are very close to the same value but have widely differing amplitudes (the side lobe level and shape factor are closest to the traditional Gaussian RBW). This window is also good for random signals.</p>	
Bartlett	<p>The Bartlett window is a slightly narrower variant of the triangular window, with zero weight at both ends.</p>	

Figure 4-24, Figure 4-25, Figure 4-26, Figure 4-27, Figure 4-28, Figure 4-29 are examples for measuring sine wave with a frequency of 1kHz under the selection of six different windows for FFT:



Figure 4-24 Hamming window

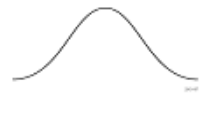
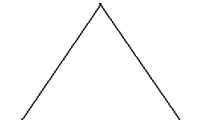
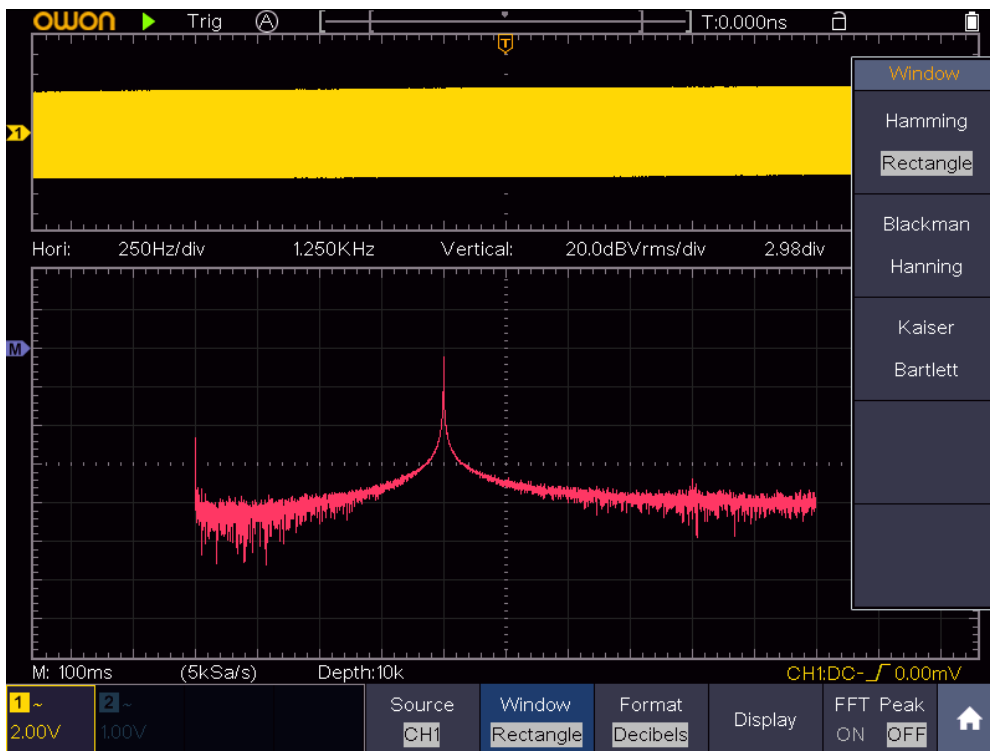

Figure 4-25 Rectangle window

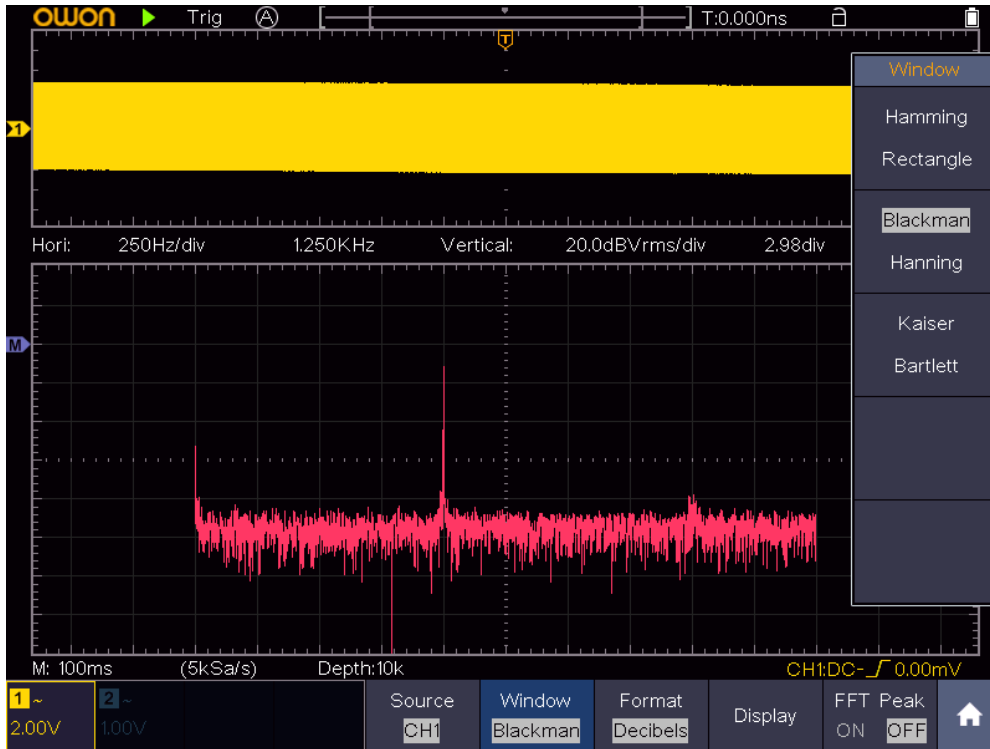

Figure 4-26 Blackman window

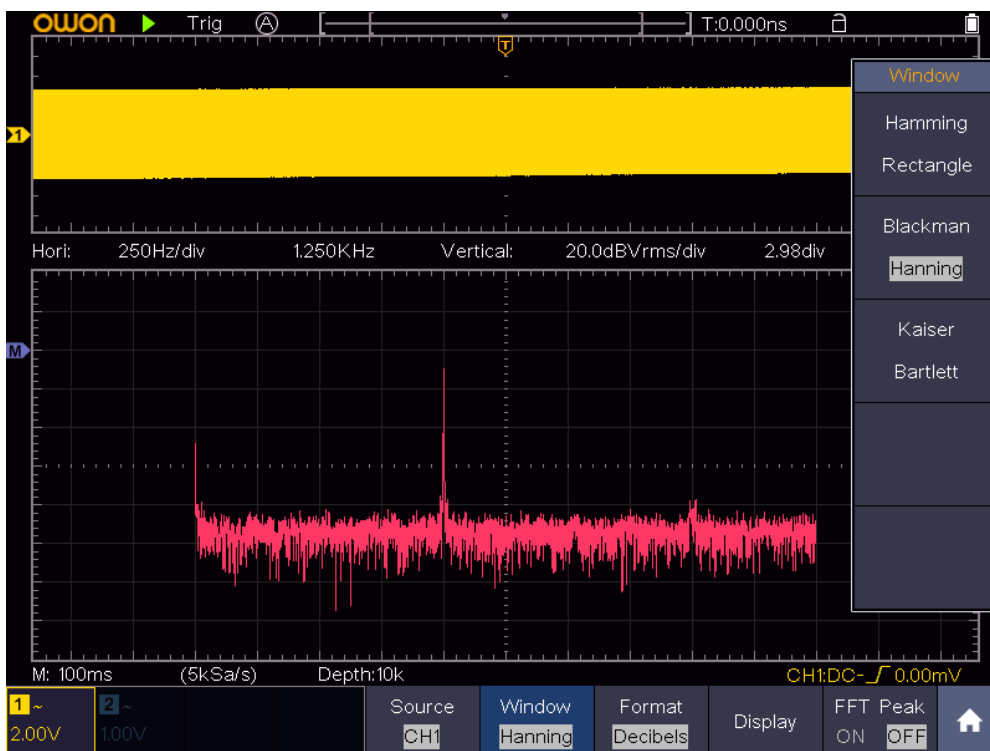

Figure 4-27 Hanning window

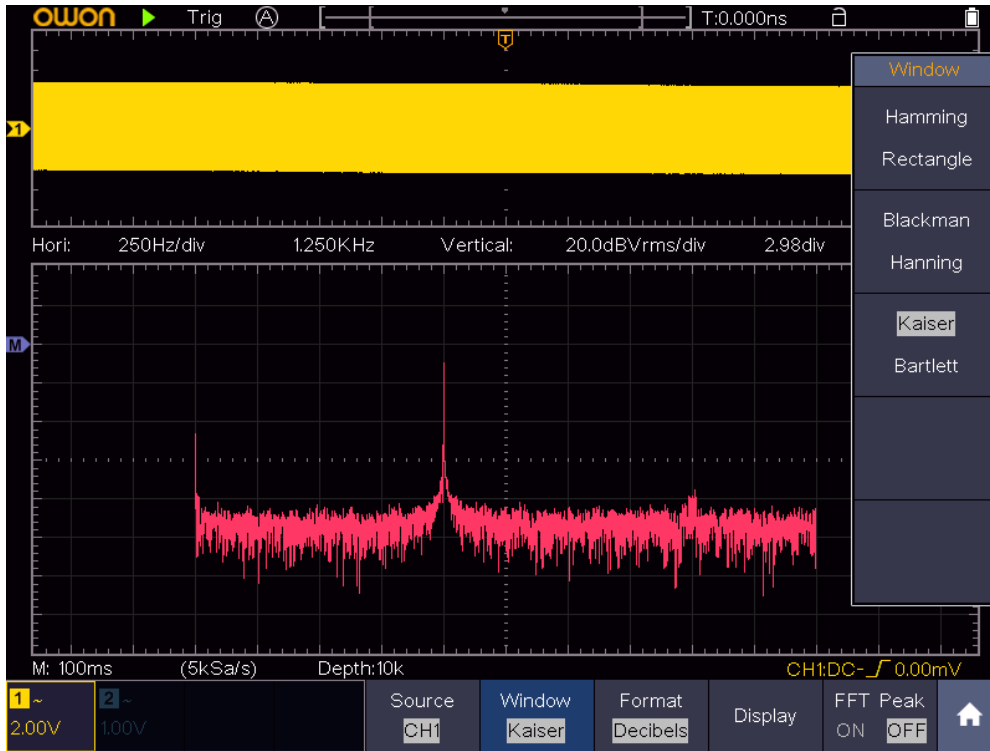

Figure 4-28 Kaiser window



Figure 4-29 Bartlett window

Notes for using FFT

- Use the default **dB** scale for details of multiple frequencies, even if they have very different amplitudes. Use the **Vrms** scale to compare frequencies.
- DC component or offset can cause incorrect magnitude values of FFT waveform. To minimize the DC component, choose AC Coupling on the source signal.
- To reduce random noise and aliased components in repetitive or single-shot events, set the oscilloscope acquisition mode to average.

What is Nyquist frequency?

The Nyquist frequency is the highest frequency that any real-time digitizing oscilloscope can acquire without aliasing. This frequency is half of the sample rate. Frequencies above the Nyquist frequency will be under sampled, which causes aliasing. So, pay more attention to the relation between the frequency being sampled and measured.

Use XY Format

Click  to call up the menu panel. Click the **XY** softkey on panel to switch to the **ON** or **OFF** state.

The XY menu:

Function Menu	Setting	Description
Full Screen	ON OFF	Turn on/off the full screen view in XY mode

This format is only applicable to Channel 1 and Channel 2. After the XY display format is selected, Channel 1 is displayed in the horizontal axis and Channel 2 in the vertical axis; the oscilloscope is set in the un-triggered sample mode: the data are displayed as bright spots.

The operations of all control knobs are as follows:

- When the **HOR** button is lit, the upper and lower knobs are used to set the horizontal scale and position.
- When one of the channel buttons is lit, the upper and lower knobs are used to set the vertical scale and position.

The following functions cannot work in the XY Format:

- Reference or digital wave form
- Cursor

- Trigger control
- FFT

Operation steps:





1. Click  to call up the menu panel. Click the **XY** softkey on panel to switch to the **ON** state.
2. To make the XY view full screen, select **Full Screen** as **ON** in the bottom menu.

Use Pass/Fail function

The **Pass/Fail** function monitors changes of signals and output pass or fail signals by comparing the input signal that is within the pre-defined mask.

Click  to call up the menu panel. Click the **P/F** softkey on panel to switch to the **ON** state.

The Pass/Fail menu:

Function Menu	Setting	Description
Operate	Start Stop	Start operation Stop operation
Output	Pass Fail Beep Stop Info	Signal tested corresponds with the rule Signal tested not correspond with the rule Beep when it satisfies the rule Stop once satisfying the rule Control the display status of info frame
Rule	Source Horizontal Vertical Create	Select the source as CH1 or CH2 Change the Horizontal tolerance value by clicking  or  Change the Vertical tolerance value by clicking  or  Use the rule set as testing rule
SaveRule	Number Save Load	Select any one from Rule1 - Rule8 as your rule name Select Save to save the rule Load some rule as the testing rule

The description of **Pass/fail Menu** is shown as the follows:

Pass/Fail test:

Detect whether the input signal is within the limits of the rule, if it exceeds limits of the rule, it is "Fail"; otherwise it is "Pass". Also, it can output fail or pass signal by built-in and configurable output port. To run the test, read the following steps:

1. Click  to call up the menu panel. Click the **P/F** softkey on panel to switch to the **ON** state.
2. **Create rule:** Select **Rule** in the bottom menu. Select **Source** in the right

menu. Set **Horizontal** tolerance and **Vertical** tolerance in the right menu. Select **Create** in the right menu to create the rule.

3. **Set output type:** Select **Output** in the bottom menu to enter output option setting. Choose any one or two of the options "**Pass**", "**Fail**" or "**Beep**". "**Pass**" and "**Fail**" are mutually exclusive options, which could not be chosen simultaneously. "**Stop**" means stop once the condition satisfies your setting.
4. **Begin to test:** Select **Operate** in the bottom menu, switch it to **Start**, the test will begin.
5. **Save rule:** Select **SaveRule** in the bottom menu. Select the save location in the left menu, and then select **Save** in the right menu to save the rules, which could be called up at once when need. Select **Load** to call up the rule saved.

Note:

1. When Pass/Fail is ON, if XY or FFT is ready to run, then Pass/Fail will be closed; under the mode of XY or FFT, Pass/Fail is unable.
2. Under the mode of Factory, Auto Scale and Auto Set, Pass/Fail will be closed.
3. When no save setting left in the rule save, tip will be given to show "NO RULE SAVED".
4. Under the status of stop, data comparing will stop, and when it goes on running, the number of Pass/Fail will increase from the former number, not from zero.
5. When the waveform playback mode is on, Pass/Fail is used to test the played-back waveform specially.

Use Executive Buttons

Executive Buttons include **Copy**, **Default**, **Run/Stop**, **Single**, **Autoset**.

Copy

You can save the waveform by just pushing the **Copy** panel button in any user interface. The source wave and the storage location are according to the settings of the **Save** function menu when the Type is **Wave**. For more details, please see "*Save Function Menu*" on P55.

Default

Shortcut keys to restore factory settings.

Run/Stop

Enable or disable sampling on input signals.

Notice: When there is no sampling at STOP state, the vertical division and the horizontal time base of the waveform still can be adjusted within a certain range, in other words, the signal can be expanded in the horizontal or vertical direction.

When the horizontal time base is $\leq 50\text{ms}$, the horizontal time base can be expanded for 4 divisions downwards.

Single

Push this button you can set the trigger mode as single directly, so when trigger occurs, acquire one waveform then stop.

Autoset

It's a very useful and quick way to apply a set of pre-set functions to the incoming signal, and display the best possible viewing waveform of the signal.

The details of functions applied to the signal when using **Autoset** are shown as the following table:

Function Items	Setting
Channel Coupling	DC
Vertical Scale	Adjust to the proper division.
Vertical Position	Adjust to the proper position.
Bandwidth	Full
Horizontal Level	Middle
Horizontal Sale	Adjust to the proper division
Trigger Type	Slope or Video
Trigger Source	The previous source before autosetting. When the previous source has no input signal, the source will be set to the minimum channel which has input signal. When all the channels have no input signal, the source will be set to CH1.
Trigger Coupling	DC
Trigger Slope	Rising edge
Trigger Level	3/5 of the Vpk-pk
Trigger Mode	Auto
Display Format	YT
Force	Stop
Help	Exit
Pass/Fail	Off
Inverted	Off
Zoom Mode	Exit
Record Length	If greater than 10M, it will be set to 10M
Waveform Math or FFT	Off
Waveform Record	Off
Slow-scan	Off
Persist	Off

Note: When the autoscale is turned on and running, the Autoset button is invalid.

Description for icon:

Cancel Autoset: Go back to display the upper menu and waveform information.

Note: The Autoset function requires that the frequency of signal should be no lower than 20Hz, and the amplitude should be no less than 5mv. Otherwise, the Autoset function may be invalid.

Print the Screen Image

To print an image of what appears on the oscilloscope screen, do as the follows:

- (1) Connect the printer to the **USB Device** port on the side panel of the oscilloscope.
Note: The USB Device port supports PictBridge compatible printers.
- (2) Click  to call up the menu panel. Click the **Utility** softkey on panel, select **Function** in the bottom menu, select **Output** in the left menu.
- (3) In the bottom menu, select **Device** as **PICT**. (When **PC** is selected, you can get an image by Oscilloscope software.)
- (4) In the bottom menu, select **Print Set**. In the right menu, set the print parameters. The **On** selection of **Ink Saver** will print out a copy with a white background.
- (5) Once you have connected a printer to your oscilloscope and set up print parameters, click **Play** in the bottom menu to print current screen images.

5. Use the Multimeter

Input Terminals

The input terminals are on the top of the oscilloscope, which marked as **COM**, **VΩ/C**.

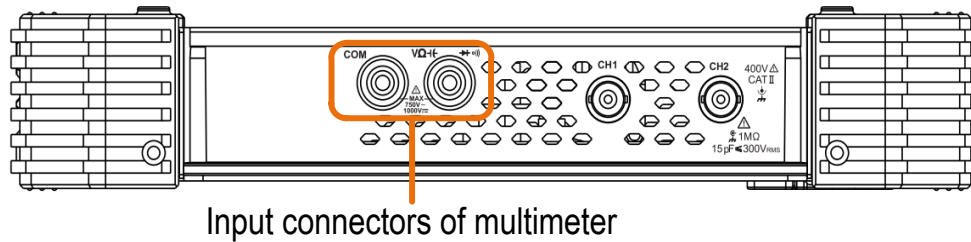

Figure 5-1 Multimeter Input Terminals

DMM Menu

Push **DMM** button on the front panel to enter/exit the multimeter function. The button backlight will be lighted when the multimeter function is enabled.

Select: Switch between AC and DC when measuring voltage or current; and switch resistance, continuity, diode, and capacitance measurement when selecting other.

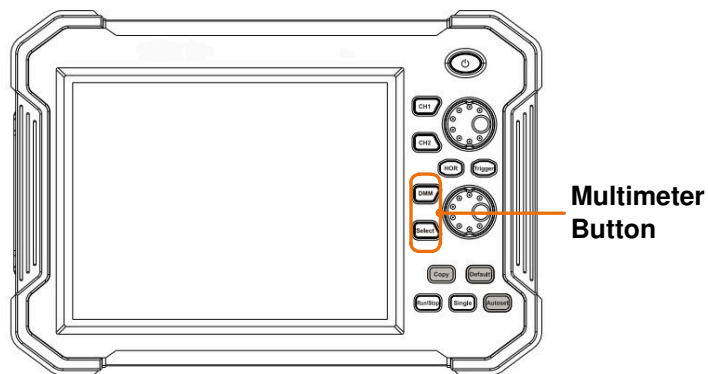



Figure 5-2 Multimeter Button

The bottom menu of multimeter is as below:

Menu	Setting	Description
Current	ACA	Measuring AC current
	DCA	Measuring DC current
Voltage	ACV	Measuring AC voltage
	DCV	Measuring DC voltage
	R	Measuring resistance
		Testing diode
		Testing for continuity

5. Use the Multimeter

	C	Measuring capacitance
Hold	ON OFF	Freeze the display during measurement.
Configure	Relative	When making relative measurements, reading is the difference between a stored reference value and the input signal.
	Show Info ON OFF	Show/Hide the information window
	Auto Range	Select auto range mode
	Switch Range	Select manual range mode, press to switch range

DMM Information Window

The Multimeter Information Window is displayed on the top right of the screen.

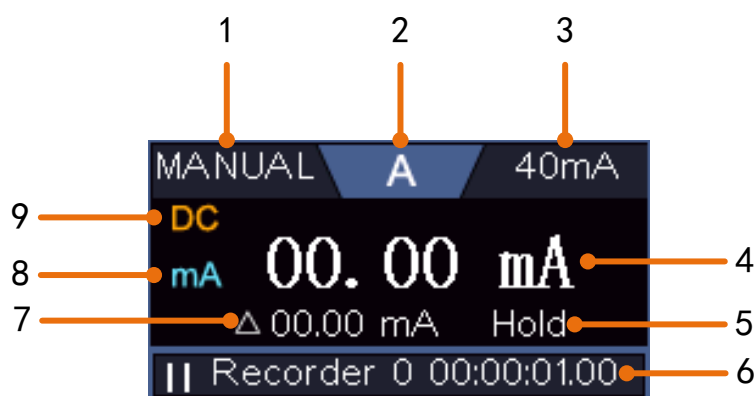



Figure 5-3 Multimeter Information Window

Description

1. Manual/Auto range indicators, **MANUAL** refers to the measuring range in manual operation mode and **AUTO** refers to the measuring range in automatic operation mode.
2. Measurement mode indicators:
 - A** ----- Current measurement
 - V** ----- Voltage measurement
 - R** ----- Resistance
 -  ----- Diode measurement
 -  ----- Continuity test
 - C** ----- Capacitance
3. Range.
4. Measurement display ("OL" is short for overload, indicates the reading exceeds the display range)
5. Data hold mode is enabled.
6. Multimeter recorder (See "Multimeter Recorder" on page 99).

7. The reference value of the relative measurement.
8. Range of measuring current: mA or 10A.
9. AC or DC when measuring current or voltage.

Making Multimeter Measurements

Measuring AC or DC Current

- (1) Push **DMM** button on the front panel. Select **Current** in the bottom menu, select it again to switch between **ACA** (AC current) or **DCA** (DC current).
- (2) Insert the current ext module provided with the oscilloscope into the COM terminal and **V/ Ω /C** terminal on the top of the oscilloscope.
- (3) Connect the black test lead to the **COM** terminal on the top of the oscilloscope. Connect the red test lead to the **mA** terminal.
- (4) Turn off the power of the measured circuit. Discharge all high- voltage capacitors.
- (5) Disconnect the circuit path to be tested. Connect the black test lead to one side of the circuit (with a lower voltage); connect the red test lead to the other side (with a higher voltage). Reversing the leads will produce a negative reading, but will not damage the multimeter.
- (6) Turn on the power of the measured circuit, and read the display.
- (7) Turn off the power of the measured circuit and discharge all high-voltage capacitors. Remove the test leads and restore the circuit to the original condition.



Measuring AC or DC Voltage

- (1) Push **DMM** button on the front panel. Select **Current** in the bottom menu, select it again to switch between **ACA** (AC current) or **DCA** (DC current).
- (2) Connect the black test lead to the **COM** terminal on the top of the oscilloscope and the red test lead to the **V/ Ω /C** terminal.
- (3) Probe the test points and read the display.

Measuring Resistance



- (1) Push **DMM** button on the front panel. Select  in the bottom menu, select **R**.
- (2) Connect the black test lead to the **COM** terminal on the top of the oscilloscope and the red test lead to the **V/ Ω /C** terminal.
- (3) Probe the test points and read the display.

Testing Diodes

- (1) Push **DMM** button on the front panel. Select  in the bottom menu, select it until switching to .

- (2) Connect the black test lead to the **COM** terminal on the top of the oscilloscope and the red test lead to the **V/ Ω /C** terminal.
- (3) Connect the red test lead to the positive terminal (anode) of the diode and the black test lead to the negative terminal (cathode). The cathode of a diode is indicated with a band. Read the diode forward bias.

Testing for Continuity

- (1) Push **DMM** button on the front panel. Select  in the bottom menu, select it until switching to .
- (2) Connect the black test lead to the **COM** terminal on the top of the oscilloscope and the red test lead to the **V/ Ω /C** terminal.
- (3) Probe the test points to measure the resistance in the circuit. If the reading is below 50 Ω , the multimeter will beep.

Measuring Capacitance

- (1) Push **DMM** button on the front panel. Select  in the bottom menu, select it until switching to **C**.
- (2) Insert the supplied capacitance measurer to the **COM** terminal and the **V/ Ω /C** terminal on the top of the oscilloscope.
- (3) Insert the capacitance to the capacitance measurer, then screen shows the capacitance reading.

Note: when measuring the capacitance which is less than 5 nF, please use relative value measuring mode to improve measuring precision.

Multimeter Features

Data Hold Mode

You can freeze the display for any function.

- (1) Select **Hold** in the bottom menu as **ON**. **HOLD** will be shown on the display.
- (2) Select **OFF** to exit this mode.

Making Relative Measurements

When making relative measurements, reading is the difference between a stored reference value and the input signal.

- (1) Select **Configure** in the bottom menu, select **Relative** in the right menu to enter the relative mode.

The measurement value at this time is stored as the reference value, and displayed behind Δ .

In this mode, current reading = input value - reference value.

- (2) Press it again to exit the mode.

Note: This function is not available when measuring resistance, diodes, and

testing for continuity.

Information Display

Show/hide the information window on the top right of the display.

- (1) Select **Configure** in the bottom menu, select **Show Info** in the right menu as **ON**. The information window will be shown on the display.
- (2) Select **OFF** to hide.

Auto or Manual Range

Auto range is set as default. To switch auto or manual range, do the following steps:

- (1) Select **Configure** in the bottom menu.
- (2) Select **Auto Range** in the right menu, **AUTO** will be shown on the display.
- (3) Select **Switch Range** in the right menu, **MANUAL** will be shown on the display. Press this softkey to switch range.

Note: When testing diode, testing continuity, and measuring capacitance, manual range is disabled.

Multimeter Recorder

You can use the multimeter data recorder to record the measurements when measuring current/voltage by multimeter (optional).





Click  to call up the menu panel. Click the **Utility** softkey on panel, select **Function** in the bottom menu, select **DAQ** in the left menu.

The description of **DAQ Menu** is shown as the follows:

Function Menu	Setting	Description
Set	Interval	Set the record interval (0.5s - 10s, step by 0.5s)
	Duration	"d h m s" represents day, hour, minute, second. E.g. "1 02:50:30" represents a day and 2 hours, 50 minutes and 30 seconds. Press Duration to switch between the time unit, click + or - to set the value. Max duration: 3 days for internal storage, 10 days for external storage.
	Enable	Turn on or off the recorder.
STRT STOP	Start or stop recording.	
Storage	Internal External	Save to internal storage or USB memory device.
Export	When internal storage is selected, you can export the internal record file to a USB memory device.	

To record the current/voltage measurements in the multimeter, do the

following:

1. Push **DDMM** button on the front panel to enter the multimeter function. Select **Current** or **Voltage** in the bottom menu.
If you want to enter the relative mode, select **Configure** in the bottom menu, select **Relative** in the right menu.
2. Click  to call up the menu panel. Click the **Utility** softkey on panel, select **Function** in the bottom menu, select **DAQ** in the left menu.
3. Select **Storage** in the bottom menu, select **Internal** or **External** in the right menu. If you select External, insert the USB memory device into the front-panel USB port on your instrument.
4. Select **Set** in the bottom menu, select **Enable** in the right menu as **ON**.
5. Select **Interval** in the right menu, click  or  to set it.
6. Select **Duration** in the right menu, push it to switch between the time unit, click  or  to set the corresponding value.
7. Select **STRT** in the bottom menu.
8. **When external storage is selected:** The instructions will be shown on the screen. The record file will be named as "Multimeter_Recorder.csv". If a file with the same name already exists in the USB memory device, it will be overwritten. (If you want to keep the existing file, back up it to other location in advance.) Select **STRT** in the bottom menu to start recording.
9. When the record time gets to the defined duration, the recording will be ended. If you want to end recording prematurely, select **STOP** in the bottom menu.

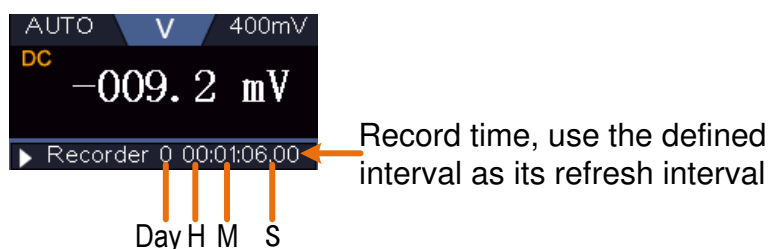

10. **When internal storage is selected:** You can export the internal record file to a USB memory device. Insert the USB memory device into the front-panel USB port on your instrument. Select **Export** in the bottom menu. The instructions will be shown on the screen. The export file will be named as "Multimeter_Recorder.csv". If a file with the same name already exists in the USB memory device, it will be overwritten. (If you want to keep the existing file, back up it to other location in advance.) Select **Export** in the bottom menu to export.

How to chart the data

You can open the CSV file using Microsoft Excel, or your favorite spreadsheet application, and create charts based on the data.

In the following steps, Microsoft Excel 2010 is used as an example.

1. Open Multimeter_Recorder.csv in Excel.

5. Use the Multimeter

	A	B	C
1	DMM RECORDER		
2	Time interval:2.0(s)		
3	DCV		
4	RELATIVE:11.600000(mV)		
5	time	index	Voltage(mV)
6		1	-0.4

Interval → 2
Measurement mode → 3
Reference value of the relative measurements → 4

2. Select the data that you want to chart (see *Figure 5-4*).
3. On the **Insert** tab, in the **Charts** group, click **Line**, and then click **Line** in 2-D Line (see *Figure 5-5*).
4. The chart will be displayed (see *Figure 5-6*). If you want to keep the chart, save the file to XLS format.

	A	B	C
1	DMM RECORDER		
2	Time interval:1.0(s)		
3	DCV		
4	RELATIVE:OFF		
5	time	index	Voltage(mV)
6		1	2.8
7		2	2.8
8		3	2.8
9		4	2.8
10		5	2.7
11		6	2.7
12		7	2.7
13		8	2.7
14		9	2.7
15	0 00:00:1	10	2.7
16		11	2.6
17		12	2.6
18		13	2.6
19		14	2.6
20		15	2.6
21		16	2.5
22		17	2.5
23		18	2.5
24		19	2.5
25	0 00:00:2	20	2.5
26		21	2.5
27		22	2.6

Figure 5-4

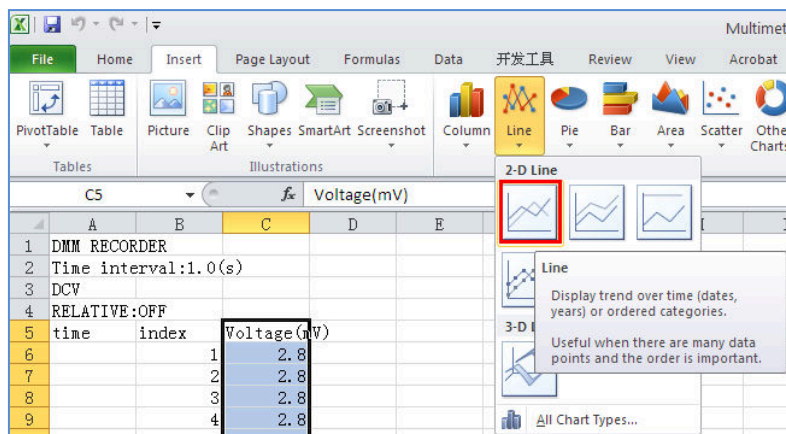

Figure 5-5

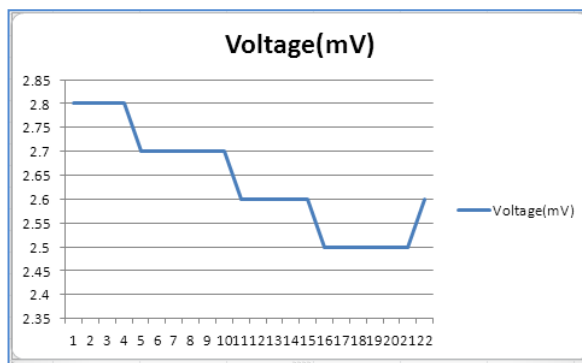

Figure 5-6

6. Communication with PC

The oscilloscope supports communications with a PC through USB, LAN port or Wi-Fi. You can use the Oscilloscope communication software to store, analyze, display the data and remote control.

To learn about how to operate the software, you can push F1 in the software to open the help document.

Here is how to connect with PC. First, install the Oscilloscope communication software on the supplied CD. Then there are several ways of connection to choose from.

Using USB Port

- (1) **Connection:** Use a USB data cable to connect the **USB Device port** in the right panel of the oscilloscope to the USB port of a PC.
- (2) **Install the driver:** Run the Oscilloscope communication software on PC, push F1 to open the help document. Follow the steps of title "**I. Device connection**" in the document to install the driver.
- (3) **Port setting of the software:** Run the Oscilloscope software; click "Communications" on the menu bar, choose "Ports-Settings", in the setting dialog, choose "Connect using" as "USB". After connect successfully, the connection information in the bottom right corner of the software will turn green.

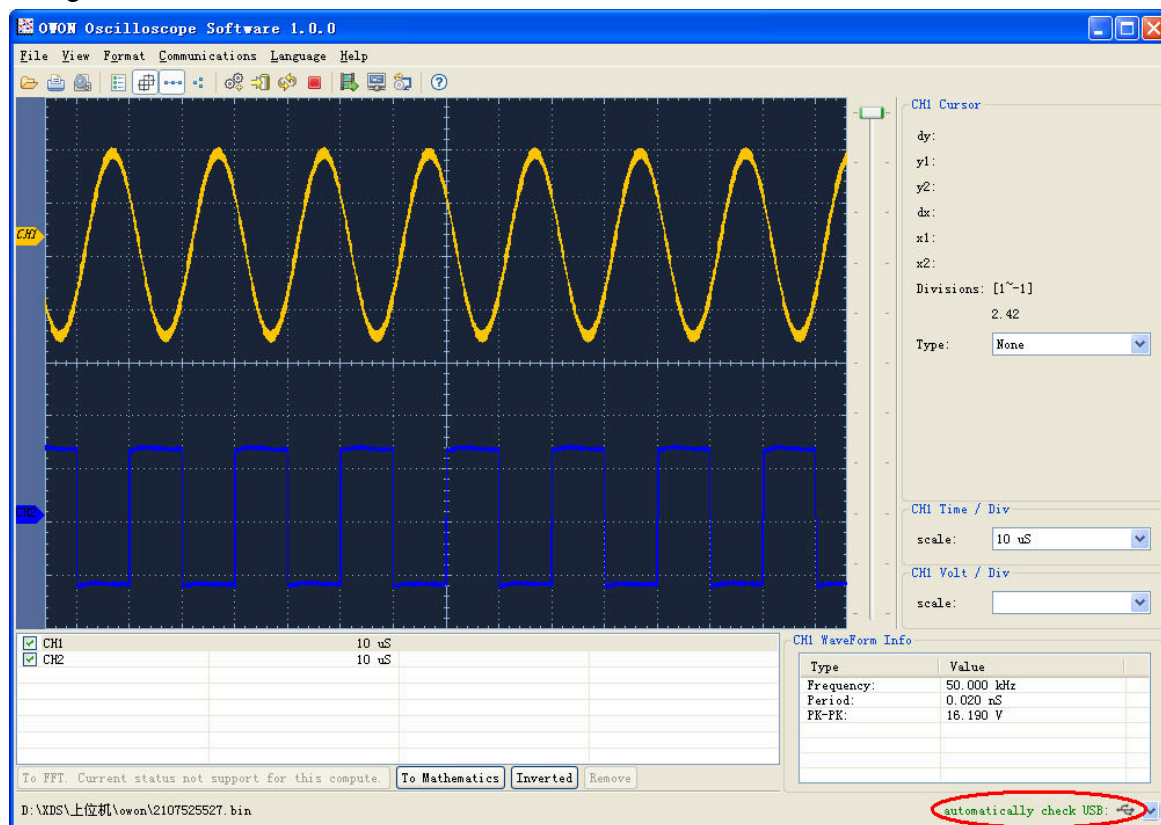

Figure 6-1 Connect with PC through USB port

Using LAN Port

Connect directly

- (1) **Connection.** Plug in the LAN cable to the LAN port in the right panel of the oscilloscope; plug the other end into the LAN interface of the computer.
- (2) **Set the network parameters of the computer.** Since the oscilloscope can not support obtaining an IP address automatically, you should assign a static IP address. Here we set the IP address to 192.168.1.71.

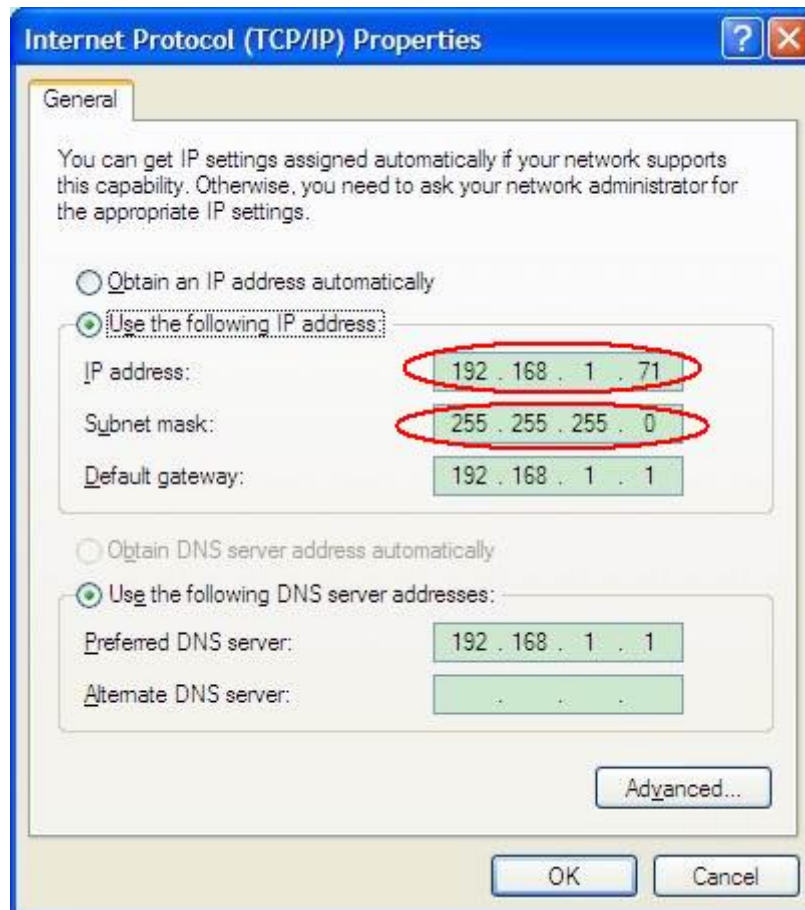

Figure 6-2 Set the network parameters of the computer

- (3) **Set the network parameters of the OWON Oscilloscope Software.** Run the software on the computer; choose the "Ports-settings" of the "Communications" menu item. Set "Connect using" to LAN. About the IP, the first three bytes is same as the IP in the step (2), the last byte should be different. Here, we set it to 192.168.1.72. The range of the port value is 0 - 4000, but the port which under 2000 is always used, so it is suggested to set it to the value above 2000. Here, we set it to 3000.

6.Communication with PC

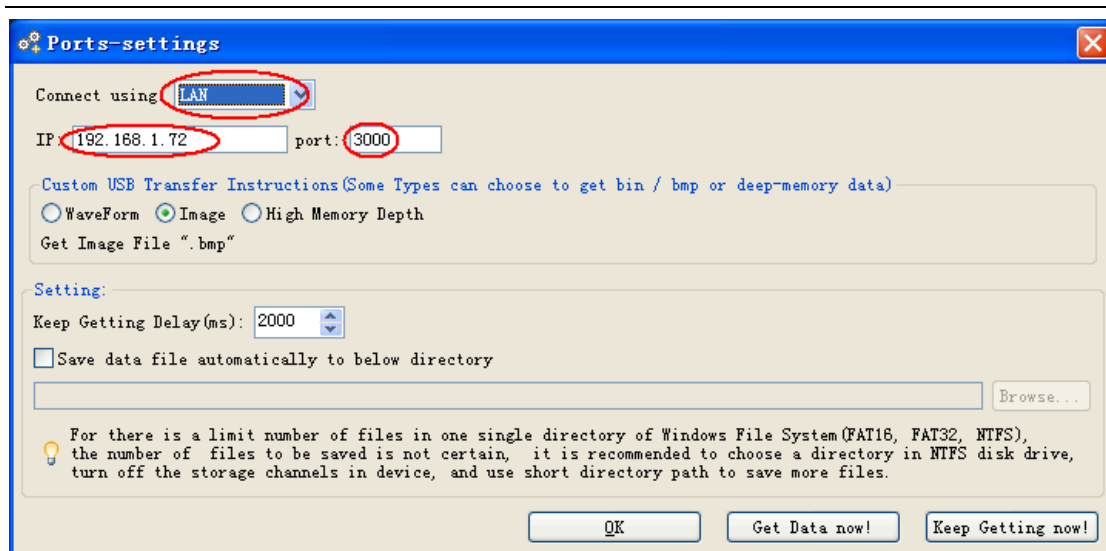



Figure 6-3 Set the network parameters of the OWON Oscilloscope Software

- (4) **Set the network parameters of the oscilloscope.** In the oscilloscope, click the  icon, click **Utility**. Select **Function** in the bottom menu. Select **LAN Set** in the left menu. In the bottom menu, set the **Type** item as **LAN**, and select **Set**. In the right menu, set **IP** and **Port** to the same value as the "Ports-settings" in the software in step (3). Select **Save set** in the bottom menu, it prompts "Reset to update the config". After resetting the oscilloscope, if you can get data normally in the oscilloscope software, the connection is successful.

Set	
IP	
M 192	168
1	72
Port	
3000	
Gateway	
192	168
1	1
Phy addr	
F3	49
12	B7
79	4
Subnet mask	
255	255
255	0

Figure 6-4 Set the network parameters of the oscilloscope

Connect through a router

- (1) **Connection.** Use a LAN cable to connect the oscilloscope with a router, the LAN port of the oscilloscope is in the right panel; the computer should be connected to the router too.
- (2) **Set the network parameters of the computer.** Since the oscilloscope can not support obtaining an IP address automatically, you should assign a static

IP address. The Default gateway and Subnet mask should be set according to the router. Here we set the IP address to 192.168.1.71, Subnet mask is 255.255.255.0, Default gateway is 192.168.1.1.

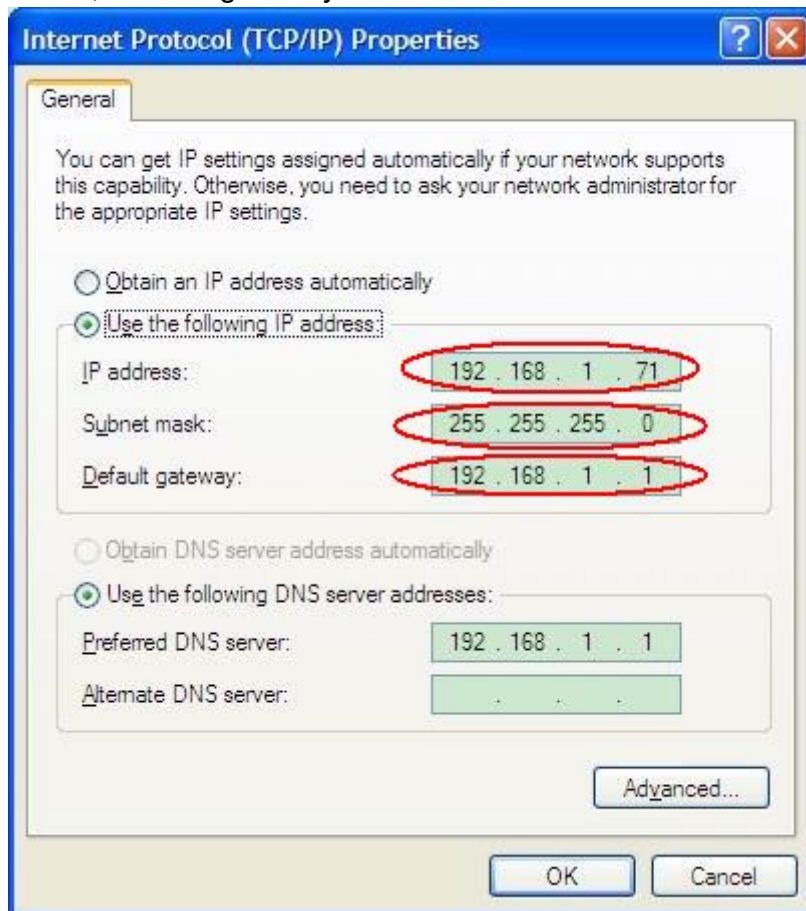

Figure 6-5 Set the network parameters of the computer

- (3) **Set the network parameters of the OWON Oscilloscope Software.** Run the software on the computer; choose the "Ports-settings" of the "Communications" menu item. Set "Connect using" to LAN. About the IP, the first three bytes is same as the IP in the step (2), the last byte should be different. Here, we set it to 192.168.1.72. The range of the port value is 0 - 4000, but the port which under 2000 is always used, so it is suggested to set it to the value above 2000. Here, we set it to 3000.

6.Communication with PC

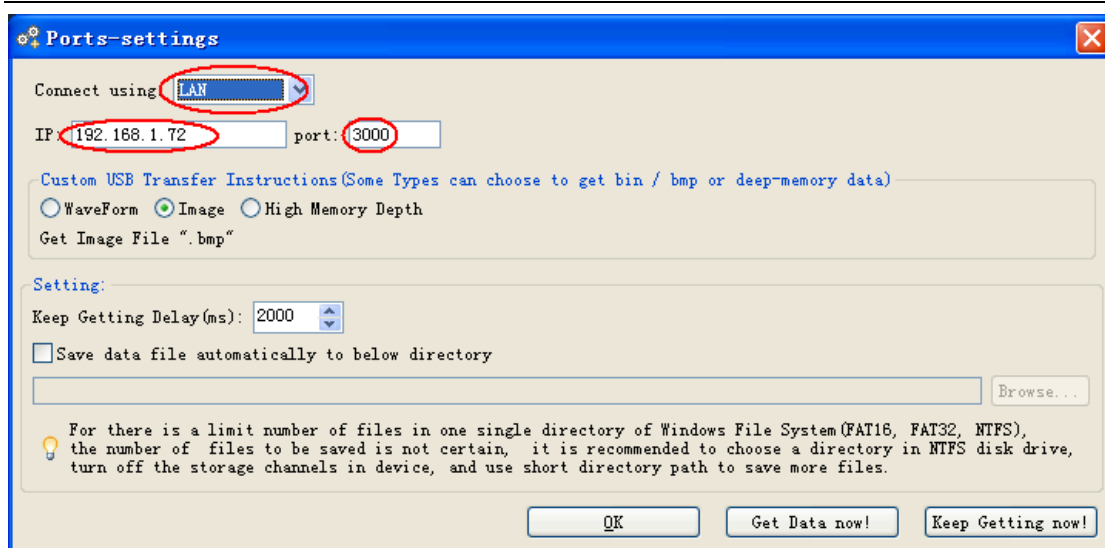



Figure 6-6 Set the network parameters of the OWON Oscilloscope Software

- (4) **Set the network parameters of the oscilloscope.** In the oscilloscope, click the  icon, click **Utility**. Select **Function** in the bottom menu. Select **LAN Set** in the left menu. In the bottom menu, set the **Type** item as **LAN**, and select **Set**. In the right menu, set **IP** and **Port** to the same value as the "Ports-settings" in the software in step (3). The Gateway and Subnet mask should be set according to the router. Select **Save set** in the bottom menu, it prompts "Reset to update the config". After resetting the oscilloscope, if you can get data normally in the oscilloscope software, the connection is successful.

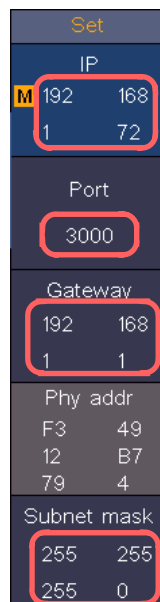





Figure 6-7 Set the network parameters of the oscilloscope

Using Wi-Fi to Connect with PC

Connect with PC as Wi-Fi Access Point

PC should support Wi-Fi.

- (1) **Set the oscilloscope.** In the oscilloscope, click the  icon, click **Utility**. Select **Function** in the bottom menu. Select **LAN Set** in the left menu. In the bottom menu, set the **Type** item as **WIFI-AP**, and select **Set** in the bottom menu.
- (2) In the right menu, select **SSID**, a keyboard will pop up. You can touch the keyboard to set the access point name.
- (3) In the right menu, select **Encryption**, push again to set the type. **Open** type needs no password. **WEP** or **WPA** type need to set the password. You can select **WPA**. In the right menu, select **Password**, use the keyboard to set the WI-FI password (8 to 32 characters).
- (4) In the right menu, select **IP:PORT**, **IP** is fixed by the oscilloscope, and cannot be edited. Here IP is 192.168.1.1. Click  or  to set the **PORT**. Here, we set it to 3000.
- (5) After setting, select **ON** in the **Status** menu. The  icon appears on the top right of the screen.

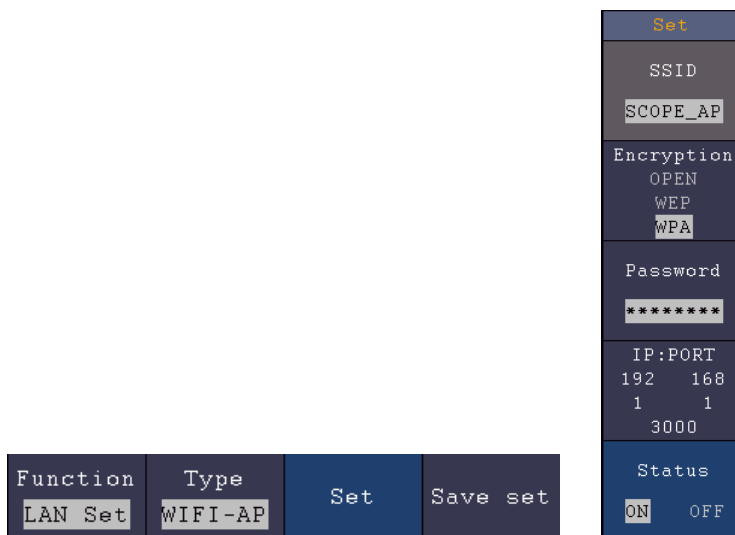

- (6) Select **Save set** in the bottom menu to save current settings.
- (7) **Set Wi-Fi connection on PC.** Enter the WI-FI settings on PC, select the oscilloscope access point to connect, enter the set password.

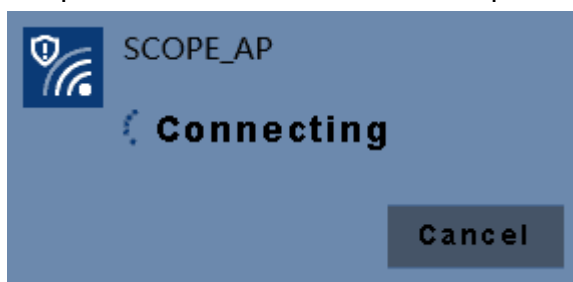

- (8) **Set the network parameters of the OWON Oscilloscope Software.** Run the software on the computer; choose the "Ports-settings" of the "Communications" menu item. Set "Connect using" to LAN. Set **IP** and **Port** to the same value in the oscilloscope in the step (4). If you can get data normally, the connection is successful.

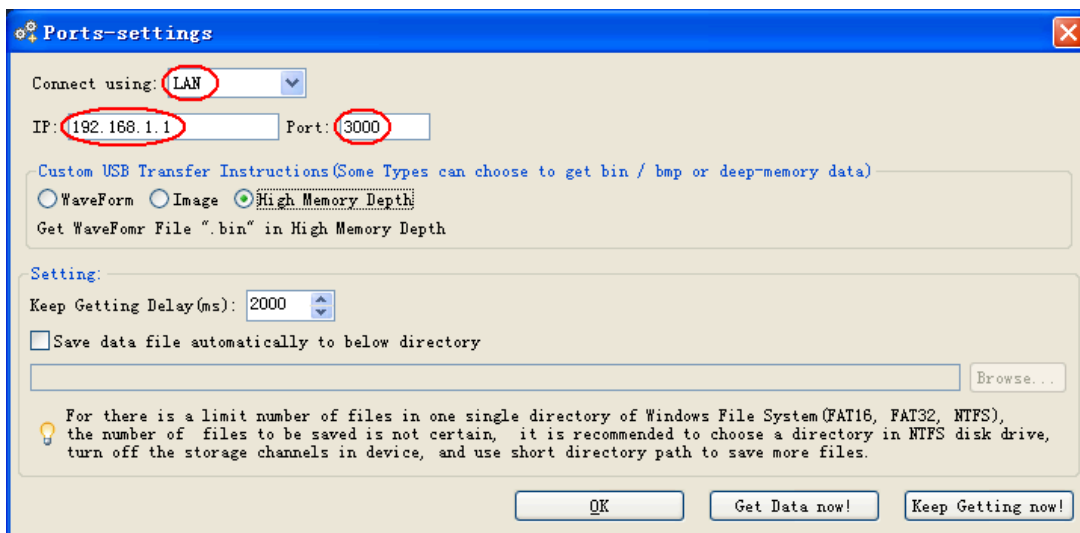
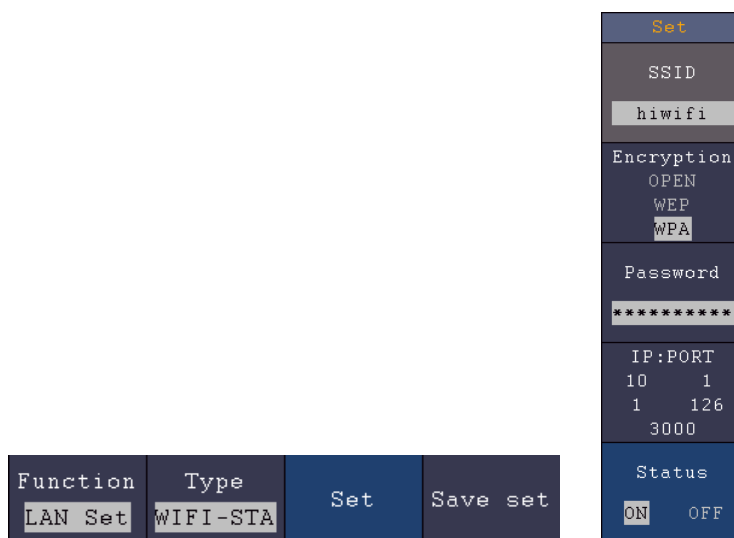

Figure 6-8 Set the network parameters of the OWON Oscilloscope Software

Connect with PC as Wi-Fi Station

The oscilloscope and PC should be on the same network (LAN).

- (1) In the oscilloscope, click the icon, click **Utility**. Select **Function** in the bottom menu. Select **LAN Set** in the left menu. In the bottom menu, set the **Type** item as **WIFI-STA**, and select **Set** in the bottom menu.
- (2) In the right menu, select **SSID**, a keyboard will pop up. Touch the keyboard to input the name of the Wi-Fi hotspot.
- (3) In the right menu, select **Encryption**, push to set the Encryption type of the Wi-Fi hotspot. **Open** type needs no password. **WEP** or **WPA** type need to input the password. In the right menu, select **Password**, use the keyboard to input the Wi-Fi hotspot password.
- (4) In the right menu, select **IP:PORT**, click **+** or **-** to set the **PORT**. Here, we set it to 3000.
- (5) After setting, select **ON** in the **Status** menu. The value of **IP** is displayed in **IP:PORT** menu. Here IP is 10.1.1.126. A changing icon appears on the top right of the screen.



- (6) Select **Save set** in the bottom menu to save current settings.

- (7) **Set the network parameters of the computer.** Set IP in the computer, the first three bytes is same as the IP in the oscilloscope, the last byte should be different. Here, we set it to 10.1.1.123. The Default gateway and Subnet mask should be set according to the router.

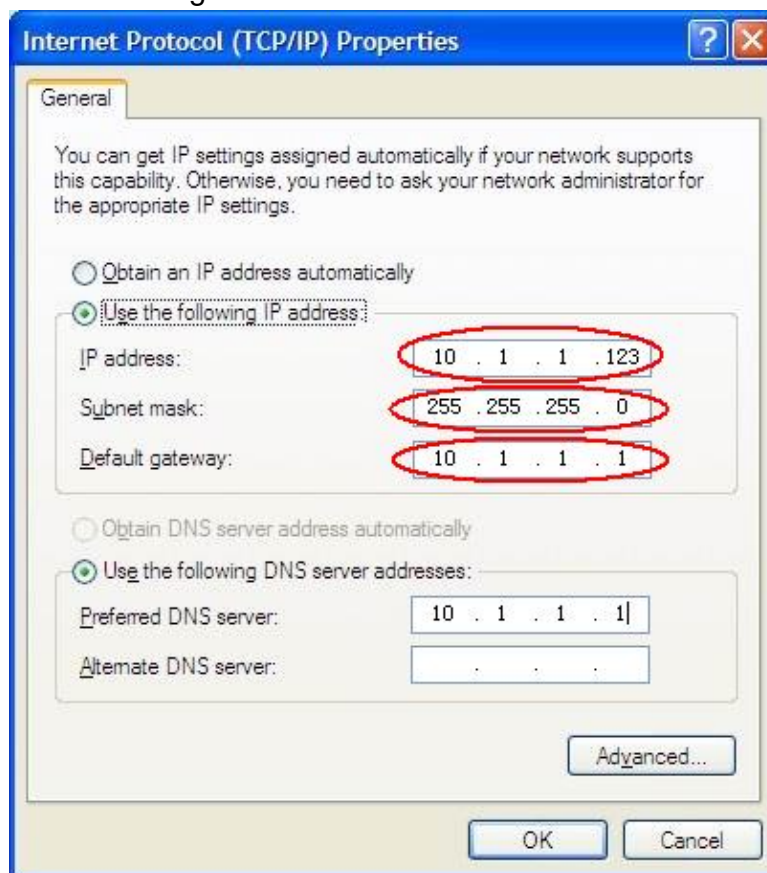

Figure 6-9 Set the network parameters of the computer

- (8) **Set the network parameters of the OWON Oscilloscope Software.** Run the software on the computer; choose the "Ports-settings" of the "Communications" menu item. Set "Connect using" to LAN. Set **IP** and **Port** to the same value in the oscilloscope. If you can get data normally, the connection is successful.

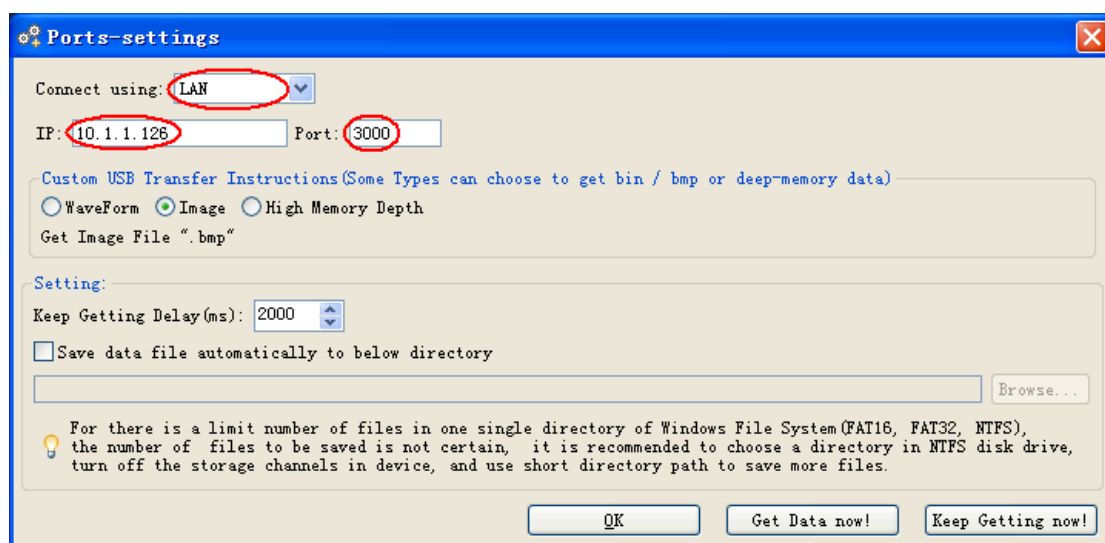

Figure 6-10 Set the network parameters of the OWON Oscilloscope Software

7. Communication with Android Device via Wi-Fi (Optional)

The oscilloscope supports communications with Android based smart device via Wi-Fi. You can use the free application software on the Android based smart devices to view the waveform synchronously, perform remote control, the waveform can be saved as image (BMP, PNG) or file (CSV, BIN), or shared via installed sharing apps.

System Requirements of Mobile Devices

- Android Versions: 4.0 and above

Install the application software

Install the free OWON application software, it can be downloaded from here:

- Scan the QR Code below with your Android based smart device. Follow the prompts on the download page to download and install the APP.



- Visit www.owon.com to download APK file and install into the device.

Note: The help content below may be not completely consistent with the application software, only for reference. Visit www.owon.com to get the latest version of this user manual.

How to Connect

In Wi-Fi settings of the oscilloscope, there are two connection types. One is WIFI-AP (Access Point), the oscilloscope is set as Wi-Fi access point, the Android device can be connected to it directly. The other type is WIFI-STA (Station), the oscilloscope is set as Wi-Fi station. The Android device can be connected to it through a Wi-Fi hotspot.

Connect with APP as Wi-Fi Access Point

- (1) In the oscilloscope, click the  icon, click **Utility**. Select **Function** in the bottom menu. Select **LAN Set** in the left menu. In the bottom menu, set the **Type** item as **WIFI-AP**, and select **Set** in the bottom menu.
- (2) In the right menu, select **SSID**, a keyboard will pop up. You can touch the

7.Communication with Android Device via Wi-Fi (Optional)

keyboard to set the access point name.

- (3) In the right menu, select **Encryption**, push again to set the type. **Open** type needs no password. **WEP** or **WPA** type need to set the password. You can select **WPA**. In the right menu, select **Password**, use the keyboard to set the Wi-Fi password (8 to 32 characters).
- (4) In the right menu, select **IP:PORT**, **IP** is fixed by the oscilloscope, and cannot be edited. Click **+** or **-** to set the **PORT**.
- (5) After setting, select **ON** in the **Status** menu. The  icon appears on the top right of the screen.

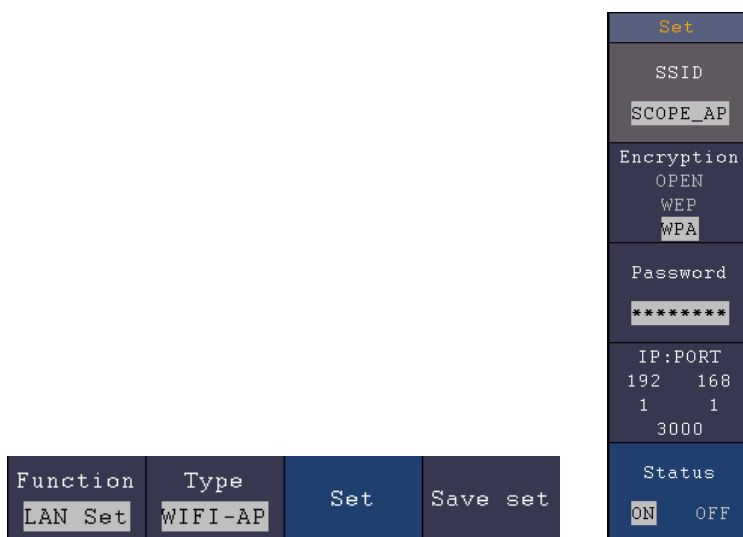

- (6) Select **Save set** in the bottom menu to save current settings.
- (7) In Android device, enter the Wi-Fi settings, select the oscilloscope access point to connect, enter the set password.

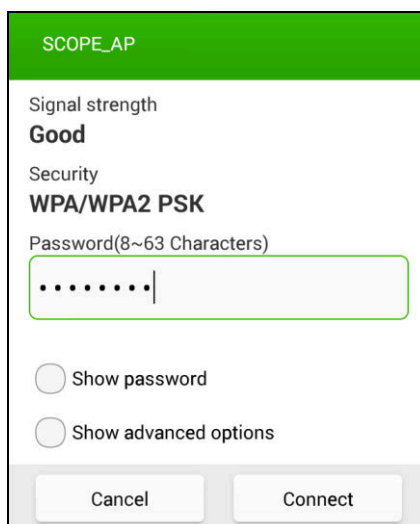

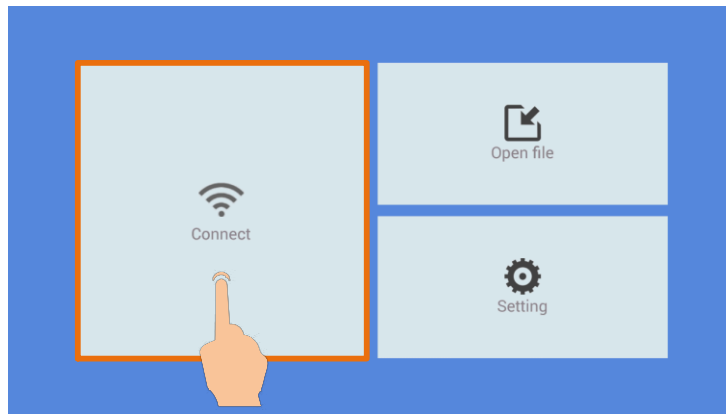

- (8) In Android device, launch the application.
- (9) Click **connect** on the left.

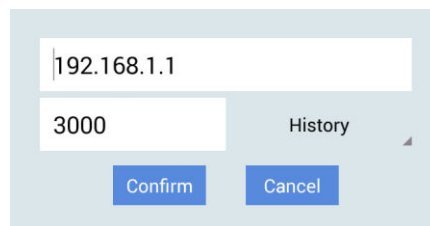

- (10) Set **IP** and **Port** to the same value as the setting in the oscilloscope. Click **Confirm** to connect. Click **History** to recall the history settings.



Connect with APP as Wi-Fi Station

- (1) In the oscilloscope, click the  icon, click **Utility**. Select **Function** in the bottom menu. Select **LAN Set** in the left menu. In the bottom menu, set the **Type** item as **WIFI-STA**, and select **Set** in the bottom menu.
- (2) In the right menu, select **SSID**, a keyboard will pop up. Touch the keyboard to input the name of the Wi-Fi hotspot.
- (3) In the right menu, select **Encryption**, push to set the Encryption type of the Wi-Fi hotspot. **Open** type needs no password. **WEP** or **WPA** type need to input the password. In the right menu, select **Password**, use the keyboard to input the Wi-Fi hotspot password.
- (4) In the right menu, select **IP:PORT**, click **+** or **-** to set the **PORT**.
- (5) After setting, select **ON** in the **Status** menu. The value of **IP** is displayed in **IP:PORT** menu. A changing icon  appears on the top right of the screen.

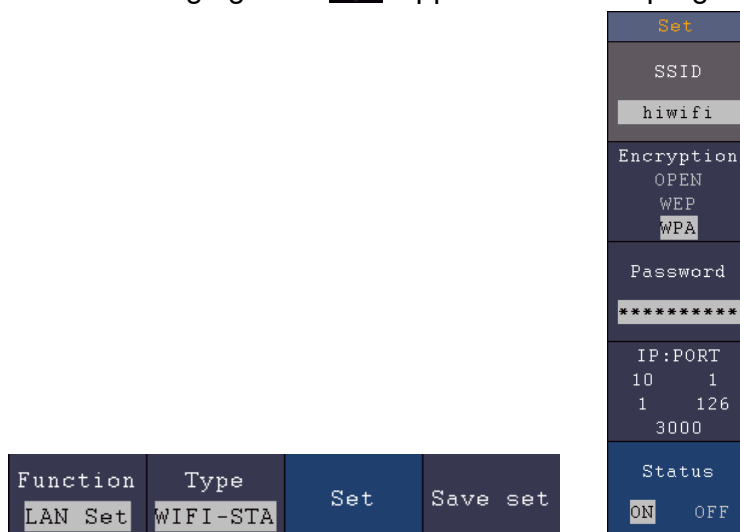

- (6) Select **Save set** in the bottom menu to save current settings.

7.Communication with Android Device via Wi-Fi (Optional)

- (7) In Android device, enter the Wi-Fi settings, select the oscilloscope access point to connect, enter the set password.

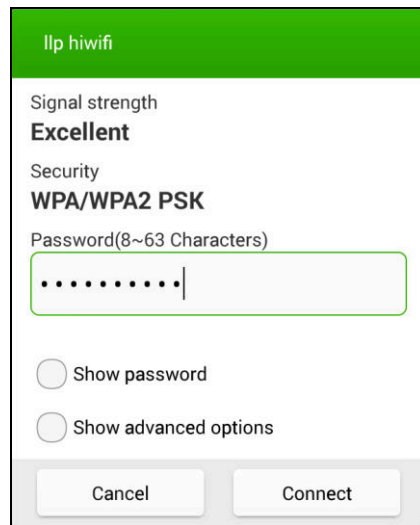

- (8) In Android device, launch the application.
(9) Click **connect** on the left.

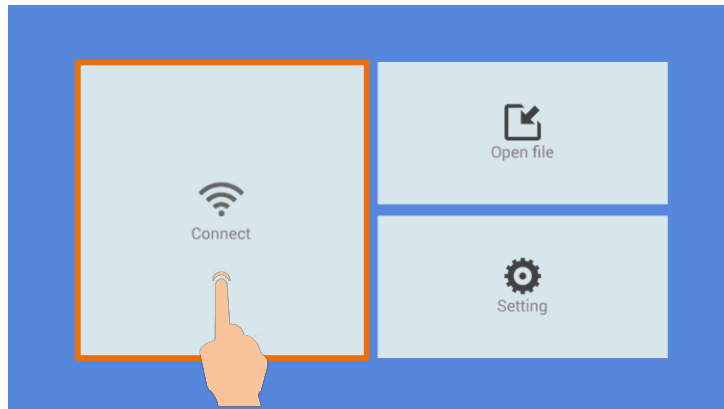

- (10) Set **IP** and **Port** to the same value as the setting in the oscilloscope. Click **Confirm** to connect. Click **History** to recall the history settings.

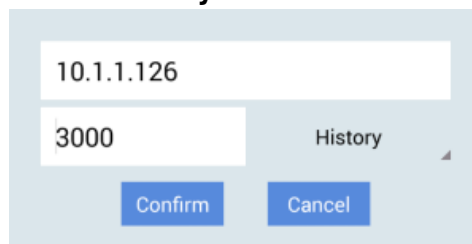

User Interface

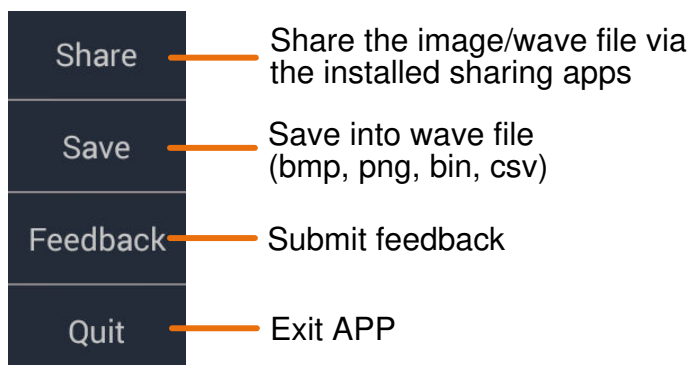
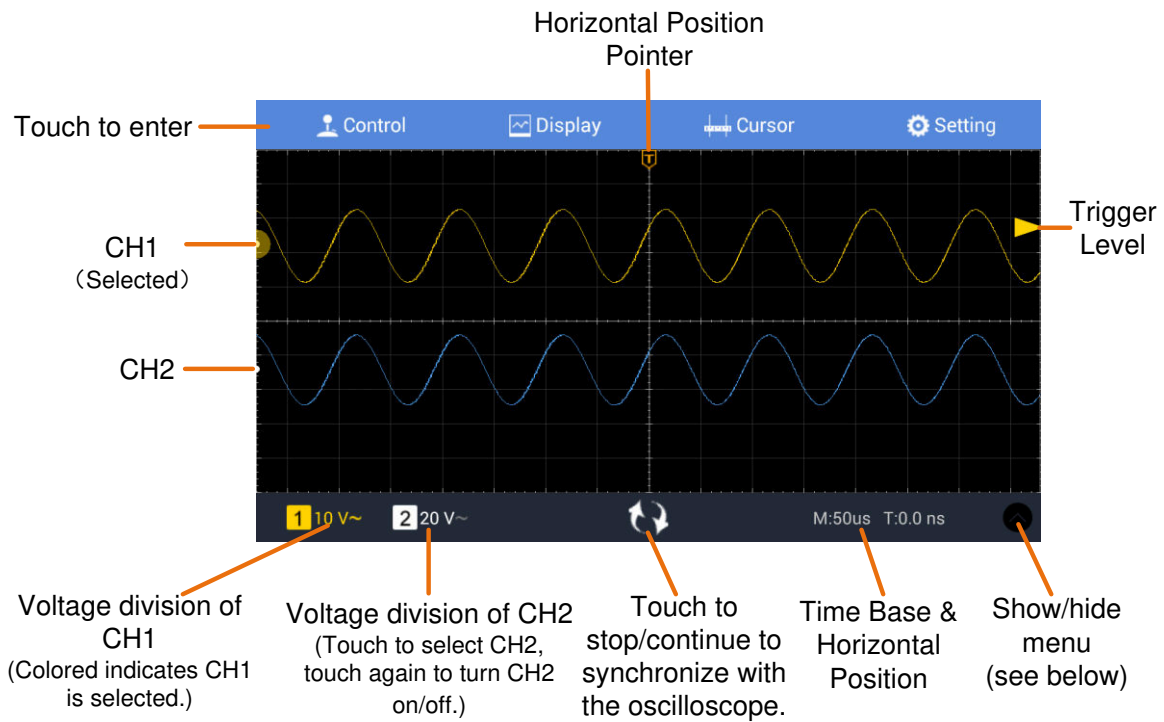

Trigger Source Menu

Swipe from the left edge of the screen to show the trigger source menu

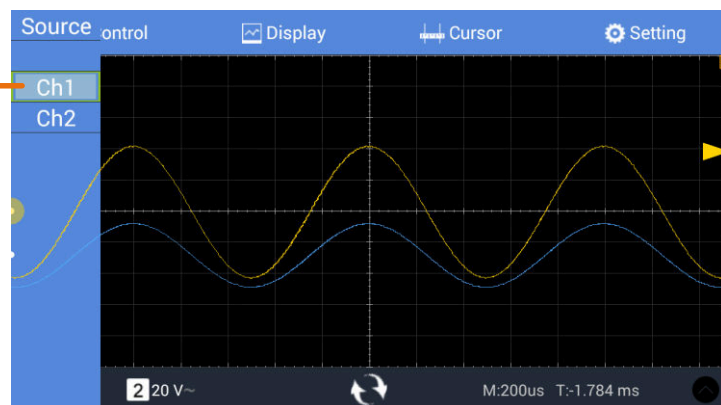

Display Menu

The points will be connected with lines Adjust the brightness of grid Set the auto measurement



Cursor Menu

Check to measure time Check to measure voltage

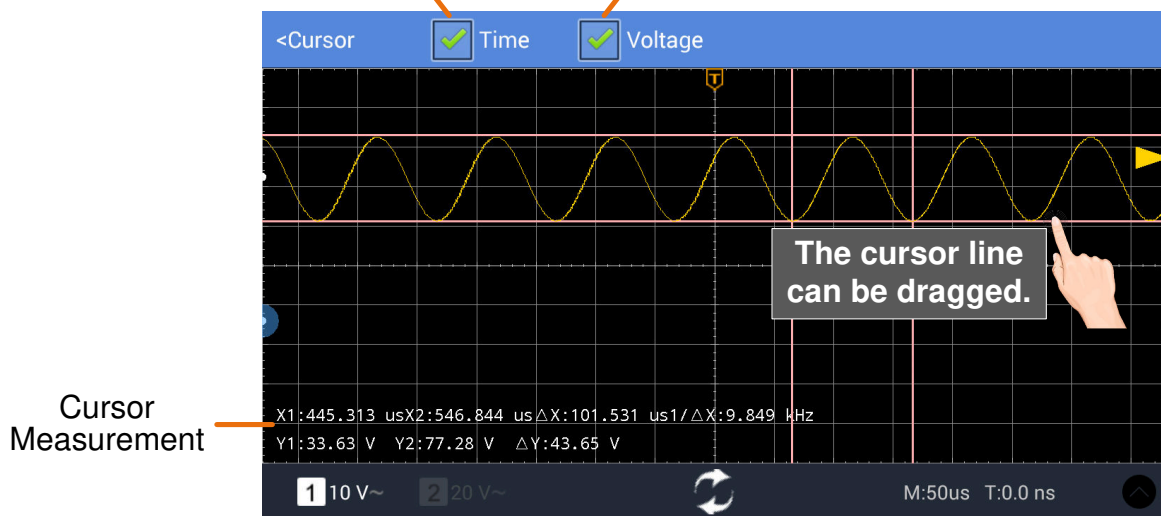

Setting Menu

APP Information



Gestures Control

Show the vertical position when gesturing

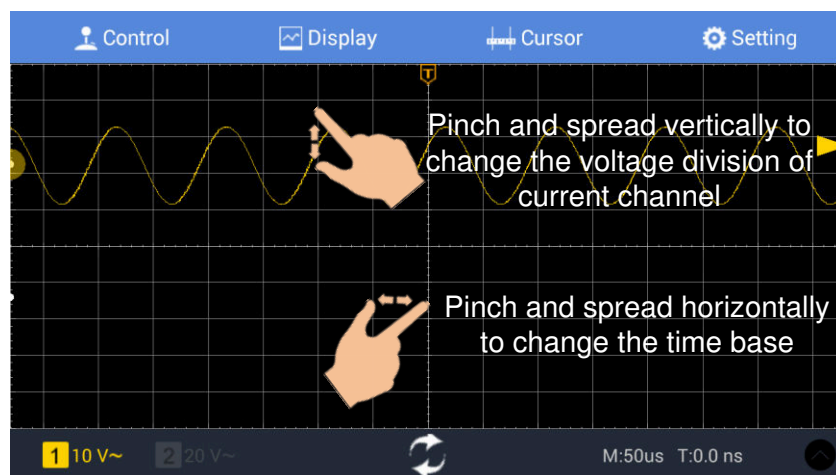
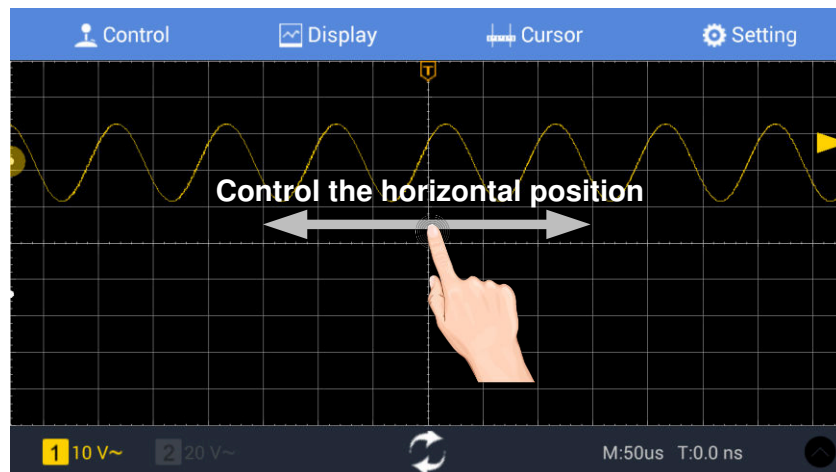
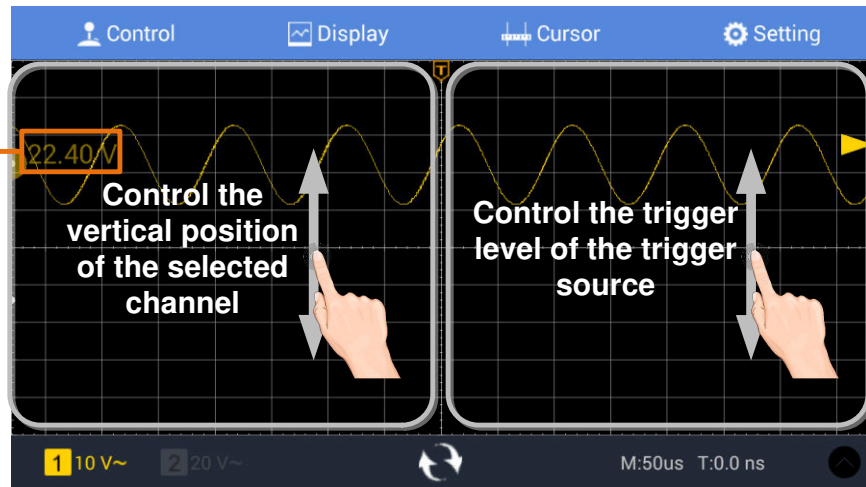

8. Demonstration

Example 1: Measurement a Simple Signal

The purpose of this example is to display an unknown signal in the circuit, and measure the frequency and peak-to-peak voltage of the signal.

1. Carry out the following operation steps for the rapid display of this signal:

- (1) Set the probe menu attenuation coefficient as **10X** and that of the switch in the probe switch as **10X** (see "*How to Set the Probe Attenuation Coefficient*" on P11).
- (2) Connect the probe of **Channel 1** to the measured point of the circuit.
- (3) Push the **Autoset** button.

The oscilloscope will implement the **Autoset** to make the waveform optimized, based on which, you can further regulate the vertical and horizontal divisions till the waveform meets your requirement.

2. Perform Automatic Measurement

The oscilloscope can measure most of the displayed signals automatically. To measure the period, the frequency of the CH1, following the steps below:

- (1) Click  to call up the menu panel. Click the **Measure** softkey on panel to display the Measure menu.
- (2) Select **Add** in the bottom menu.
- (3) In the left Type menu, select **Period**.
- (4) In the right menu, select **CH1** in the **Source** menu item.
- (5) In the right menu, select **Add**. The period type is added.
- (6) In the left Type menu, select **Frequency**.
- (7) In the right menu, select **CH1** in the **Source** menu item.
- (8) In the right menu, select **Add**. The frequency type is added.

The measured value will be displayed at the bottom left of the screen automatically (see *Figure 8-1*).

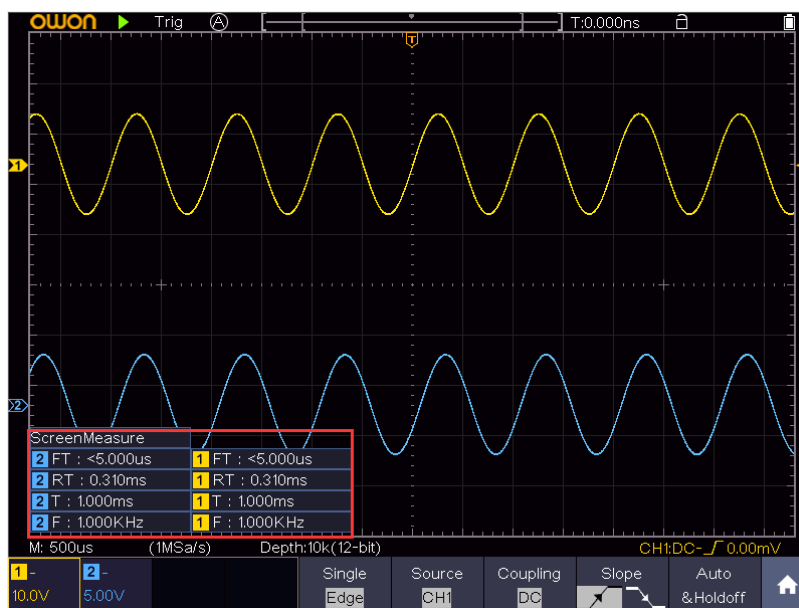

Figure 8-1 Measure period and frequency value for a given signal

Example 2: Gain of a Amplifier in a Metering Circuit

The purpose of this example is to work out the Gain of an Amplifier in a Metering Circuit. First we use Oscilloscope to measure the amplitude of input signal and output signal from the circuit, then to work out the Gain by using given formulas.

Set the probe menu attenuation coefficient as **10X** and that of the switch in the probe as **10X** (see "*How to Set the Probe Attenuation Coefficient*" on P11).

Connect the oscilloscope CH1 channel with the circuit signal input end and the CH2 channel to the output end.

Operation Steps:

- (1) Push the **Autoset** button and the oscilloscope will automatically adjust the waveforms of the two channels into the proper display state.
- (2) Click  to call up the menu panel. Click the **Measure** softkey on panel to display the Measure menu.
- (3) Select **Add** in the bottom menu.
- (4) In the left Type menu, select **PK-PK**.
- (5) In the right menu, select **CH1** in the **Source** menu item.
- (6) In the right menu, select **Add**. The peak-to-peak type of CH1 is added.
- (7) In the left Type menu, select **PK-PK**.
- (8) In the right menu, select **CH2** in the **Source** menu item.
- (9) In the right menu, select **Add**. The peak-to-peak type of CH2 is added.
- (10) Read the peak-to-peak voltages of Channel 1 and Channel 2 from the

bottom left of the screen (see *Figure 8-2*).

(11) Calculate the amplifier gain with the following formulas.

$$\text{Gain} = \text{Output Signal} / \text{Input signal}$$

$$\text{Gain (db)} = 20 \times \log (\text{gain})$$

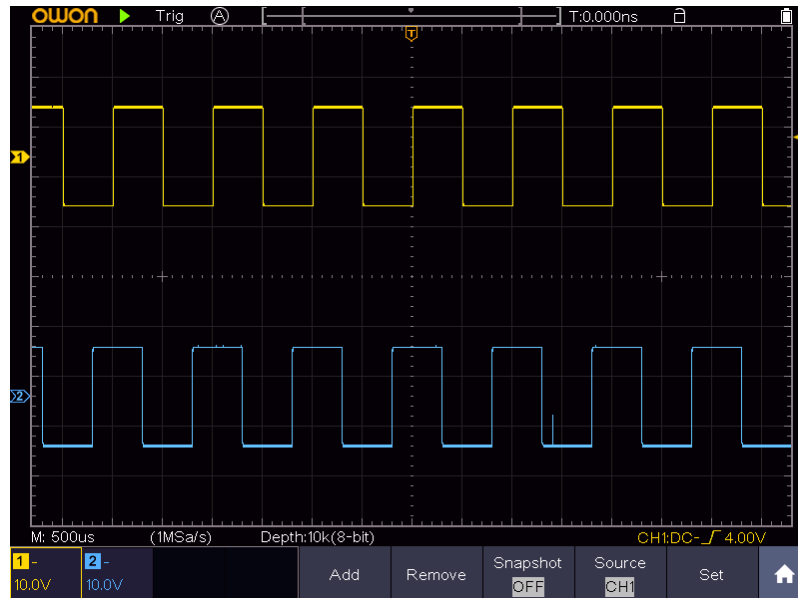





Figure 8-2 Waveform of Gain Measurement

Example 3: Capturing a Single Signal

It's quite easy to use Digital Oscilloscope to capture non-periodic signal, such as a pulse and burr etc. But the common problem is how to set up a trigger if you have no knowledge of the signal? For example, if the pulse is the logic signal of a TTL level, the trigger level should be set to 2 volts and the trigger edge be set as the rising edge trigger. With various functions supported by our Oscilloscope, user can solve this problem by taking an easy approach. First to run your test using auto trigger to find out the closest trigger level and trigger type, this helps user to make few small adjustments to achieve a proper trigger level and mode. Here is how we achieve this.

The operation steps are as follows:

- (1) Set the probe menu attenuation coefficient to 10X and that of the switch in the probe to 10X (see "*How to Set the Probe Attenuation Coefficient*" on P11).
- (2) Push **CH1** button to select CH1, turn the lower knob to adjust the vertical scale. Press the **HOR** button to make it light, turn the lower knob to adjust the horizontal scale. Set up a proper vertical and horizontal ranges for the signal to be observed.
- (3) Click  to call up the menu panel. Click the **Acquire** softkey on panel to

- display the Acquire menu.
- (4) Select **Acqu Mode** in the bottom menu. Select **Peak Detect** in the right menu.
 - (5) Click  to call up the menu panel. Click the **Trig Menu** softkey on panel to display the Trigger menu.
 - (6) Select the first menu item in the bottom menu. Select **Single** in the right menu.
 - (7) In the left menu, select **Edge** as the mode.
 - (8) Select **Source** in the bottom menu. Select **CH1** in the right menu.
 - (9) Select **Coupling** in the bottom menu. Select **DC** in the right menu.
 - (10) In the bottom menu, select **Slope** as  (rising).
 - (11) Turn the upper knob and adjust the trigger level to the roughly 50% of the signal to be measured.
 - (12) Check the Trigger State Indicator on the top of the screen, if it is not Ready, push down the **Run/Stop** button and start acquiring, wait for trigger to happen. If a signal reaches to the set trigger level, one sampling will be made and then displayed in the screen. By using this approach, a random pulse can be captured easily. For instance, if we want to find a burst burr of high amplitude, set the trigger level to a slightly higher value of the average signal level, push the **Run/Stop** button and wait a trigger. Once there is a burr occurring, the instrument will trigger automatically and record the waveform during the period around the trigger time. When the **HOR** button is lit, by turning the upper knob on the front panel, you can change the horizontal triggering position to obtain the negative delay, making an easy observation of the waveform before the burr occurs (see *Figure 8-3*).

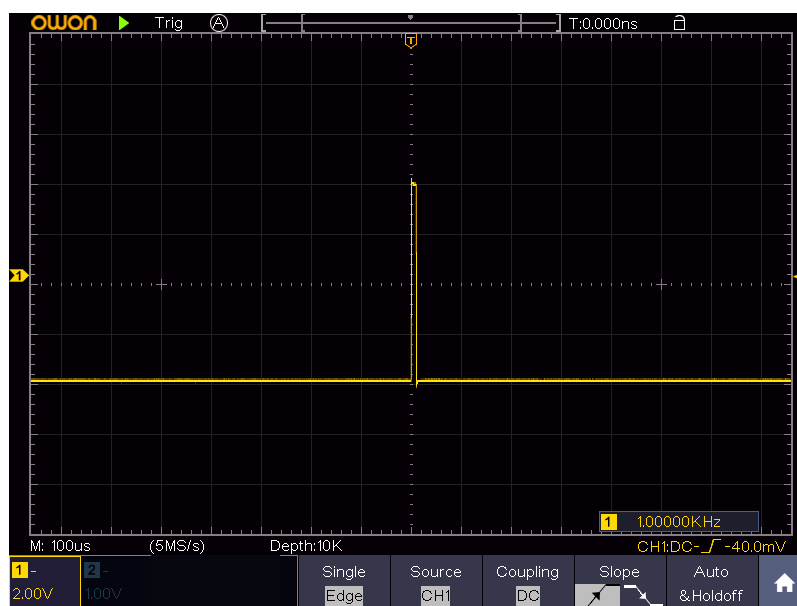



Figure 8-3 Capturing a Single Signal

Example 4: Analyze the Details of a Signal

Noise is very common inside most of the electronic signal. To find out what's inside the noise and reduce the level of noise is very important function our oscilloscope is capable to offer.

Noise Analysis

The level of noise sometime indicates a failure of electronic circuit. The Peak Detect functions acts an important role to help you to find out the details of these noise. Here is how we do it:

- (1) Click  to call up the menu panel. Click the **Acquire** softkey on panel to display the Acquire menu.
- (2) Select **Acqu Mode** in the bottom menu.
- (3) Select **Peak Detect** in the right menu.

The signal displayed on the screen containing some noise, by turning on Peak Detect function and changing time base to slow down the incoming signal, any peaks or burr would be detected by the function (see *Figure 8-4*).

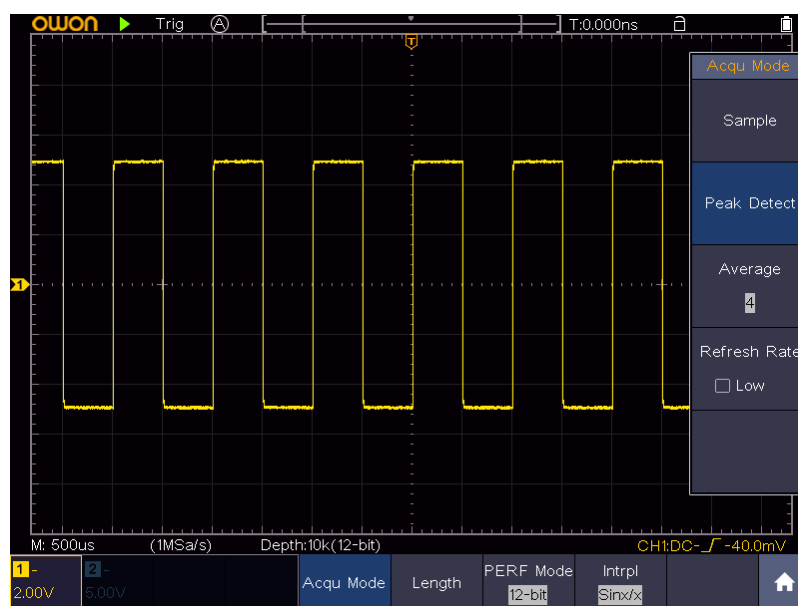



Figure 8-4 Signal with Noises

Separate Noises from the Signal

When focusing on signal itself, the important thing is to reduce the noise level as lower as possible, this would enable user to have more details about the signal. The Average function offered by our Oscilloscope can help you to achieve this.

Here are the steps for how to enable Average function.

- (1) Click  to call up the menu panel. Click the **Acquire** softkey on panel to display the Acquire menu.

- (2) Select **Acqu Mode** in the bottom menu.
- (3) Select **Average** in the right menu, select the average number in the left menu, observe the waveform obtained from averaging the waveforms of different average number.

User would see a much-reduced random noise level and make it easy to see more details of the signal itself. After applying Average, user can easily identify the burrs on the rising and falling edges of some part of the signal (see *Figure 8-5*).

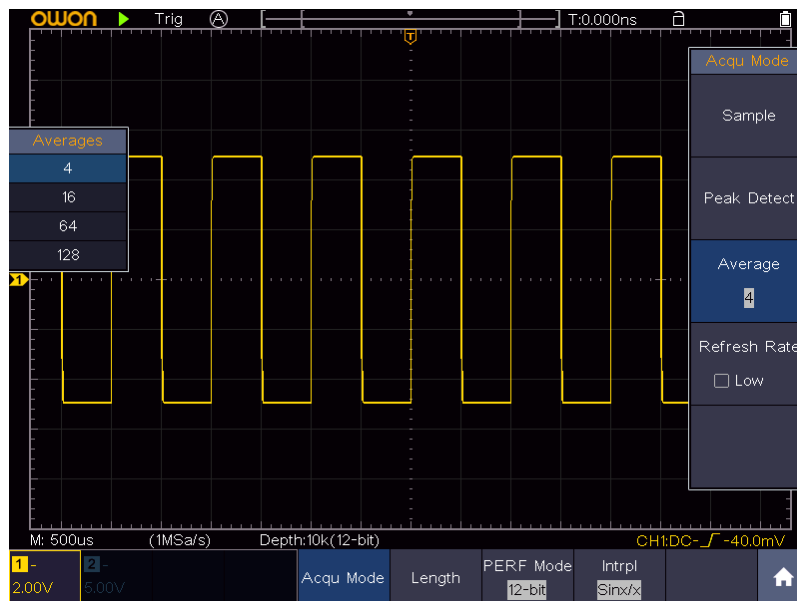

Figure 8-5 Reduce Noise level by using Average function

Example 5: Application of X-Y Function

Examine the Phase Difference between Signals of two Channels

Example: Test the phase change of the signal after it passes through a circuit network.

X-Y mode is a very useful when examining the Phase shift of two related signals. This example takes you step by step to check out the phase change of the signal after it passes a specified circuit. Input signal to the circuit and output signal from circuit are used as source signals.

For the examination of the input and output of the circuit in the form of X-Y coordinate graph, please operate according to the following steps:

- (1) Set the probe menu attenuation coefficient for **10X** and that of the switch in the probe for **10X** (see "*How to Set the Probe Attenuation Coefficient*" on P11).
- (2) Connect the probe of channel 1 to the input of the network and that of Channel 2 to the output of the network.

8.Demonstration

- (3) Push the CH1 and CH2 button to turn on CH1 and CH2.
- (4) Push the **Autoset** button, with the oscilloscope turning on the signals of the two channels and displaying them in the screen.
- (5) Push **CH1** button to select CH1, turn the lower knob, and then push **CH2** button to select CH2, turn the lower knob, making the amplitudes of two signals equal in the rough.
- (6) Click  to call up the menu panel. Click the **XY** softkey on panel to switch to the **ON** state. The oscilloscope will display the input and terminal characteristics of the network in the Lissajous graph form.
- (7) Turn the upper and lower knobs, optimizing the waveform.
- (8) With the elliptical oscillogram method adopted, observe and calculate the phase difference (see *Figure 8-6*).

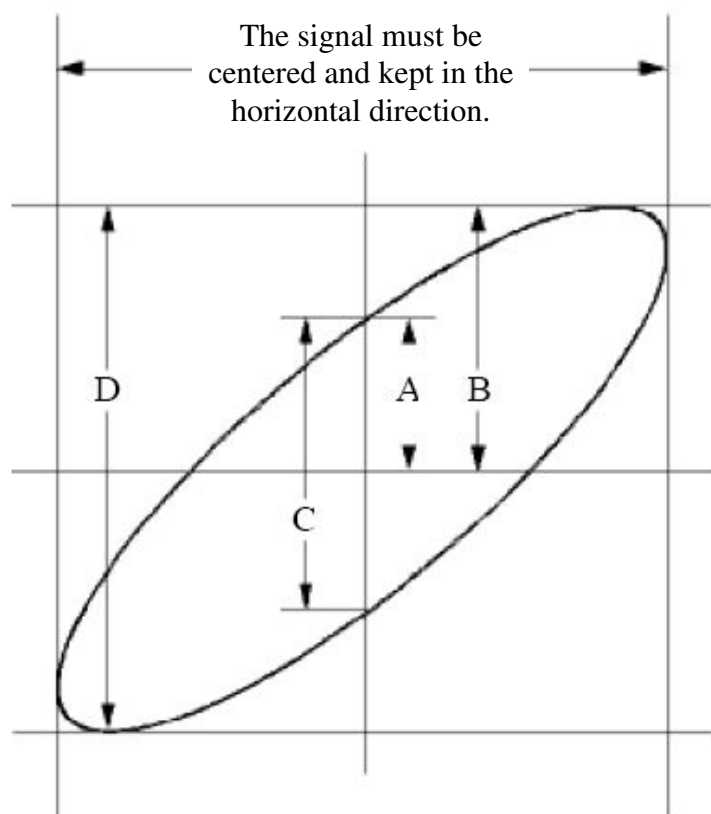

Figure 8-6 Lissajous Graph

Based on the expression $\sin(\mathbf{q}) = \mathbf{A/B}$ or $\mathbf{C/D}$, thereinto, \mathbf{q} is the phase difference angle, and the definitions of A, B, C, and D are shown as the graph above. As a result, the phase difference angle can be obtained, namely, $\mathbf{q} = \pm \arcsin(\mathbf{A/B})$ or $\pm \arcsin(\mathbf{C/D})$. If the principal axis of the ellipse is in the I and III quadrants, the determined phase difference angle should be in the I and IV quadrants, that is, in the range of $(0 - \pi/2)$ or $(3\pi/2 - 2\pi)$. If the principal axis of the ellipse is in the II and IV quadrants, the determined phase difference angle is in the II and III quadrants, that is, within the range of $(\pi/2 - \pi)$ or $(\pi - 3\pi/2)$.

Example 6: Video Signal Trigger

Observe the video circuit of a television, apply the video trigger and obtain the stable video output signal display.

Video Field Trigger

For the trigger in the video field, carry out operations according to the following steps:

- (1) Click  to call up the menu panel. Click the **Trig Menu** softkey on panel to display the Trigger menu.
- (2) Select the first menu item in the bottom menu. Select **Single** in the right menu.
- (3) In the left menu, select **Video** as the mode.
- (4) Select **Source** in the bottom menu. Select **CH1** in the right menu.
- (5) Select **Modu** in the bottom menu. Select **NTSC** in the right menu.
- (6) Select **Sync** in the bottom menu. Select **Field** in the right menu.
- (7) Adjust the vertical scale, vertical position and horizontal scale to obtain a proper waveform display (see *Figure 8-7*).

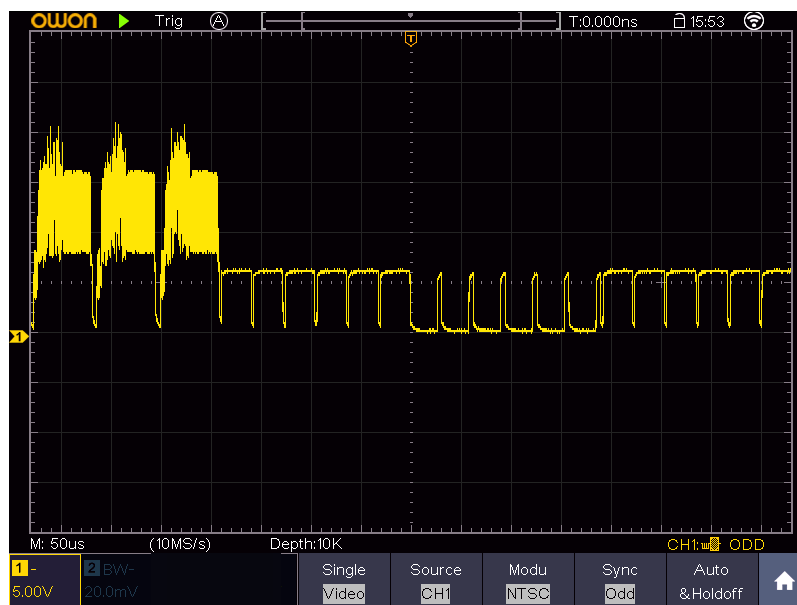

Figure 8-7 Waveform Captured from Video Field Trigger

9. Troubleshooting

1. Oscilloscope is powered on but no Display.

- Check whether the power connection is connected properly.
- Restart the instrument after completing the checks above.
- If the problem persists, please contact OWON and we will be under your service.

2. After acquiring the signal, the waveform of the signal is not displayed in the screen.

- Check whether the probe is properly connected to the signal connecting wire.
- Check whether the signal connecting wire is correctly connected to the BNC (namely, the channel connector).
- Check whether the probe is properly connected with the object to be measured.
- Check whether there is any signal generated from the object to be measured (the trouble can be shot by the connection of the channel from which there is a signal generated with the channel in fault).
- Make the signal acquisition operation again.

3. The measured voltage amplitude value is 10 times or 1/10 of the actual value.

Look at the attenuation coefficient for the input channel and the attenuation ration of the probe, to make sure they are match (see "*How to Set the Probe Attenuation Coefficient*" on P11).

4. There is a waveform displayed, but it is not stable.

- Check whether the **Source** item in the **TRIG MODE** menu is in conformity with the signal channel used in the practical application.
- Check on the trigger **Type** item: The common signal chooses the **Edge** trigger mode for **Type** and the video signal the **Video**. Only if a proper trigger mode is applied, the waveform can be displayed steadily.
- Try to change the trigger coupling into the high frequency suppress to smooth the high frequency noise triggered by the interference.

5. No Display Responses to the Push-down of Run/Stop.

Check whether Normal or Single is chosen for Polarity in the TRIG MODE menu and the trigger level exceeds the waveform range.

If it is, make the trigger level is centered in the screen or set the trigger mode as Auto. In addition, with the **Autoset** button pressed, the setting above can be completed automatically.

6. The displaying of waveform seems getting slow after increasing **AVERAGE** value in **Acqu Mode** (see "*Implement Sampling Setup*" on P48), or a longer duration is set in the **Persist in Display** (see "*Persist*" on P53).

It's normal as the Oscilloscope is working hard on many more data points.

10. Technical Specifications

Unless otherwise specified, the technical specifications applied are for TAO3000 dual-channel series only, and Probes attenuation set as 10X. Only if the oscilloscope fulfills the following two conditions at first, these specification standards can be reached.

- This instrument should run for at least 30 minutes continuously under the specified operating temperature.
- If change of the operating temperature is up to or exceeds 5°C, do a "Self-calibration" procedure (see "*How to Implement Self-calibration*" on P13).

All specification standards can be fulfilled, except one(s) marked with the word "Typical".

Oscilloscope

Performance Characteristics		Instruction		
Bandwidth	TAO3072 TAO3072A	70 MHz		
	TAO3102 TAO3102A	100 MHz		
	TAO3122 TAO3122A	120 MHz		
Vertical Resolution (A/D)	TAO3072 TAO3102 TAO3122	8 bits		
	TAO3072A TAO3102A TAO3122A	8 bits/12 bits/14 bits		
	Channel	2		
Waveform Capture Rate	45,000 wfms/s			
Multi-level Gray Scale Display & Color Temperature Display (Use gray scale to indicate frequency of occurrence, where frequently occurring waveform are bright.)	Support			
Magnifier Function (The magnifier window can display the magnified wave of the wave selection horizontally and vertically.)	TAO3072 TAO3102 TAO3122	Not support		
	TAO3072A TAO3102A TAO3122A	Support		
	Acquisition	Mode	Normal, Peak detect, Averaging	
	Sample rate	TAO3072	Dual CH	500 MSa/s

10. Technical Specifications

Performance Characteristics		Instruction			
Input	(real time)	TAO3102 TAO3122	Single CH		1 GSa/s
		TAO3072A TAO3102A TAO3122A	8 bits mode	Dual CH	500 MSa/s
				Single CH	1 GSa/s
			12 bits mode	Dual CH	250 MSa/s
				Single CH	500 MSa/s
		14 bits mode	Dual CH	100 MSa/s	
			Single CH	100 MSa/s	
	Input coupling	DC, AC, Ground			
	Input impedance	1 MΩ±2%, in parallel with 15 pF±5 pF			
	Input coupling	0.001X - 1000X, step by 1 – 2 - 5			
	Max input voltage	400 V (DC + AC Peak)			
	Bandwidth limit	20 MHz, full bandwidth			
	Channel –channel isolation	50Hz: 100 : 1 10MHz: 40 : 1			
	Time delay between channel(typical)	150ps			
Horizontal System	Sampling rate range	TAO3072 TAO3102 TAO3122	Dual CH		0.05 Sa/s - 500 MSa/s
			Single CH		0.05 Sa/s - 1 GSa/s
		TAO3072A TAO3102A TAO3122A	8 bits mode	Dual CH	0.05 Sa/s - 500 MSa/s
				Single CH	0.05 Sa/s - 1 GSa/s
		12 bits mode	Dual CH	0.05 Sa/s - 250 MSa/s	
			Single CH	0.05 Sa/s - 500 MSa/s	
		14 bits mode	Dual CH	0.05 Sa/s - 100 MSa/s	
			Single CH	0.05 Sa/s - 100 MSa/s	
	Interpolation	(Sinx)/x, x			
	Max Record length	When two channels are turned on, the max record length is 20M; and max 40M for one channel.			
Scanning speed (S/div)	2ns/div - 1000s/div, step by 1 – 2 - 5				
Sampling rate / relay time accuracy	±10 ppm max (Ta = +25°C)				

10. Technical Specifications

Performance Characteristics		Instruction			
	Interval(ΔT) accuracy (DC - 100MHz)	Single: $\pm(1 \text{ interval time} + 1 \text{ ppm} \times \text{reading} + 0.6 \text{ ns})$; Average >16: $\pm(1 \text{ interval time} + 1 \text{ ppm} \times \text{reading} + 0.4 \text{ ns})$			
	Sensitivity	1 mV/div - 10 V/div			
	Displacement	$\pm 2 \text{ V}$ (1 mV/div – 50 mV/div); $\pm 20 \text{ V}$ (100 mV/div – 1 V/div); $\pm 200 \text{ V}$ (2 V/div – 10 V/div)			
Vertical system	Analog bandwidth	TAO3072 TAO3072A	70 MHz		
		TAO3102 TAO3102A	100 MHz		
		TAO3122 TAO3122A	120 MHz		
	Single bandwidth	TAO3072 TAO3072A	DC to 70 MHz		
		TAO3102 TAO3102A	DC to 100 MHz		
		TAO3122 TAO3122A	DC to 120 MHz		
	Low Frequency	$\geq 10 \text{ Hz}$ (at input, AC coupling, -3 dB)			
	Rise time (at input, Typical)	TAO3072 TAO3072A	$\leq 5.0 \text{ ns}$		
		TAO3102 TAO3102A	$\leq 3.5 \text{ ns}$		
		TAO3122 TAO3122A	$\leq 2.9 \text{ ns}$		
	DC gain accuracy	TAO3072 TAO3102 TAO3122	1 mV	$\pm 4\%$	
			$\geq 2 \text{ mV}$	$\pm 3\%$	
		TAO3072A TAO3102A	8 bits mode	1 mV	$\pm 4\%$
TAO3122A		12 bits mode	1 mV	$\pm 3\%$	
		14 bits mode	$\geq 2 \text{ mV}$	$\pm 2\%$	
DC accuracy (average)	Delta Volts between any two averages of ≥ 16 waveforms acquired with the same scope setup and ambient conditions (ΔV): $\pm(3\% \text{ rdg} + 0.05 \text{ div})$				
	Waveform inverted ON/OFF				
Measurement	Cursor	ΔV , ΔT , $\Delta T \& \Delta V$ between cursors, auto cursor			

10. Technical Specifications

Performance Characteristics		Instruction
	Automatic	Period, Frequency, Mean, PK-PK, RMS, Max, Min, Top, Base, Amplitude, Overshoot, Preshoot, Rise Time, Fall Time, +Pulse Width, -Pulse Width, +Duty Cycle, -Duty Cycle, Delay A→B $\overline{\mu}$, Delay A→B $\overline{\mu}$, Cycle RMS, Cursor RMS, Screen Duty, FRR, FRF, FFR, FFF, LRR, LRF, LFR, LFF, Phase A→B $\overline{\mu}$, Phase A→B $\overline{\mu}$, +Pulse Count, -Pulse Count, Rise Edge Count, Fall Edge Count, Area, and Cycle Area.
	Waveform Math	+, -, *, / ,FFT, FFTrms, Intg, Diff, Sqrt, User Defined Function, digital filter (low pass, high pass, band pass, band reject)
	Decoding Type (optional)	UART, I ² C, SPI, CAN
	Waveform storage	100 waveforms
	Lissajous figure	Bandwidth Phase difference
Communication port	USB Host, USB Device; Trig Out(Pass/Fail); LAN port	
Printer Compatibility	PictBridge	
Counter	Support	

Trigger

Performance Characteristics		Instruction
Trigger level range	Internal	± 5 div from the screen center
Trigger level Accuracy (typical)	Internal	± 0.3 div
Trigger displacement	According to Record length and time base	
Trigger Holdoff range	100 ns – 10 s	
50% level setting (typical)	Input signal frequency ≥ 50 Hz	
Edge trigger	slope	Rising, Falling
Video Trigger	Modulation	Support standard NTSC, PAL and SECAM broadcast systems
	Line number range	1-525 (NTSC) and 1-625 (PAL/SECAM)

10. Technical Specifications

Pulse trigger	Trigger condition	Positive pulse: >, <, = Negative pulse: >, <, =
	Pulse Width range	30 ns to 10 s
Slope Trigger	Trigger condition	Positive pulse: >, <, = Negative pulse: >, <, =
	Time setting	30 ns to 10 s
Runt Trigger	Polarity	Positive, Negative
	Pulse Width Condition	>, =, <
	Pulse Width Range	30 ns to 10 s
Windows Trigger	Polarity	Positive, Negative
	Trigger Position	Enter, Exit, Time
	Windows Time	30 ns to 10 s
Timeout Trigger	Edge Type	Rising, Falling
	Idle Time	30 ns to 10 s
Nth Edge Trigger	Edge Type	Rising, Falling
	Idle Time	30 ns to 10 s
	Edge Number	1 to 128
Logic Trigger	Logic Mode	AND, OR, XNOR, XOR
	Input Mode	H, L, X, Rising, Falling
	Output Mode	Goes True, Goes False, Is True >, Is True <, Is True =
UART Trigger	Polarity	Normal, Inverted
	Trigger Condition	Start, Error, Check Error, Data
	Baud Rate	Common, Custom
	Data Bits	5 bit, 6 bit, 7 bit, 8 bit
I2C Trigger	Trigger Condition	Start, Restart, Stop, ACK Lost, Address, Data, Addr/Data
	Address Bits	7 bit, 8 bit, 10 bit
	Address Range	0 to 127, 0 to 255, 0 to 1023
	Byte Length	1 to 5
SPI Trigger	Trigger Condition	Timeout
	Timeout Value	30 ns to 10 s
	Data Bits	4 bit to 32 bit
	Data Line Setting	H, L, X
CAN Trigger (optional)	Signal Type	CAN_H, CAN_L, TX, RX
	Trigger Condition	Start of Frame, Type of Frame, Identifier, Data, ID & Data, End of Frame, Missing Ack, Bit Stuffing Error
	Baud Rate	Common, Custom

10. Technical Specifications

	Sample Point	5% to 95%
	Frame Type	Data, Remote, Error, Overload

Multimeter

Performance Characteristics	Instruction
Full scale reading	4½ digits (Max 19999 – count)
Diode	0 V - 2 V
Input impedance	10 MΩ
On/Off measurement	<50Ω beeping
Capacitance	2nF - 20mF: ±(4.0%+10 digit)
Voltage	DCV: 20mV, 200mV: ±(0.5%+10digit); 2V, 20V, 200V: ±(0.3%+5digit); 1000V: ±(0.5%+5digit) Max. input: DC 1000V ACV: 20mV, 200mV, 2V, 20V, 200V: ±(0.8%+10digit) 750V: ±(1%+10digit) Frequency: 40Hz-1000Hz, Max. input: AC 750V (virtual value)
Current	DCA: 20A: ±(2%+10digit) ACA: 20A: ±(2.5%+10digit)
Impedance	200Ω: ±(0.8%+10digit) 2KΩ - 2MΩ: ±(0.5%+3digit) 20MΩ: ±(0.8%+5digit) 100MΩ: ±(5.0%+10digit)

General Technical Specifications

Display

Display Type	8" Colored LCD (Liquid Crystal Display)
Display Resolution	800 (Horizontal) × 600 (Vertical) Pixels
Display Colors	65536 colors, TFT screen

Output of the Probe Compensator

Output Voltage (Typical)	About 5 V, with the Peak-to-Peak voltage ≥1 MΩ.
Frequency (Typical)	Square wave of 1 KHz

Power

Mains Voltage	100V – 240 VACRMS, 50/60 Hz, CAT II
Power Consumption	<15 W
Fuse	2 A, T class, 250 V
Battery	7.4V, 8000mAh The battery can last approximately 5 hours (differ in models) after a full recharge.

Environment

10. Technical Specifications

Temperature	Working temperature: 0 °C - 40 °C Storage temperature: -20 °C - 60 °C
Relative Humidity	≤ 90%
Height	Operating: 3,000 m Non-operating: 15,000 m
Cooling Method	Fan cooling

Mechanical Specifications

Dimension	270 mm × 191 mm × 48 mm (L*H*W)
Weight	Approx. 1.7 kg (without accessories)

Interval Period of Adjustment:

One year is recommended for the calibration interval period.

11. Appendix

Appendix A: Enclosure

(The accessories subject to final delivery.)

Standard Accessories:



Power Cord



CD Rom

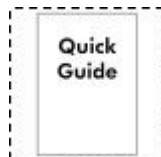

Quick Guide



Micro USB Cable



Probes



Probe Adjust



AC-DC Adapter



Stand Holder



BNC-SAM

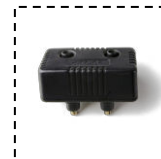

Current Ext
Module



Multimeter Lead

Options:



Bag

Appendix B: General Care and Cleaning

General Care

Do not store or leave the instrument where the liquid crystal display will be exposed to direct sunlight for long periods of time.

Caution: To avoid any damage to the instrument or probe, do not exposed it to any sprays, liquids, or solvents.

Cleaning

Inspect the instrument and probes as often as operating conditions require. To clean the instrument exterior, perform the following steps:

1. Wipe the dust from the instrument and probe surface with a soft cloth. Do not make any scuffing on the transparent LCD protection screen when clean the LCD screen.
2. Disconnect power before cleaning your Oscilloscope. Clean the instrument with a wet soft cloth not dripping water. It is recommended to scrub with soft detergent or fresh water. To avoid damage to the instrument or probe, do not use any corrosive chemical cleaning agent.



Warning: Before power on again for operation, it is required to confirm that the instrument has already been dried completely, avoiding any electrical short circuit or bodily injury resulting from the moisture.

Appendix C: Battery Using Guide

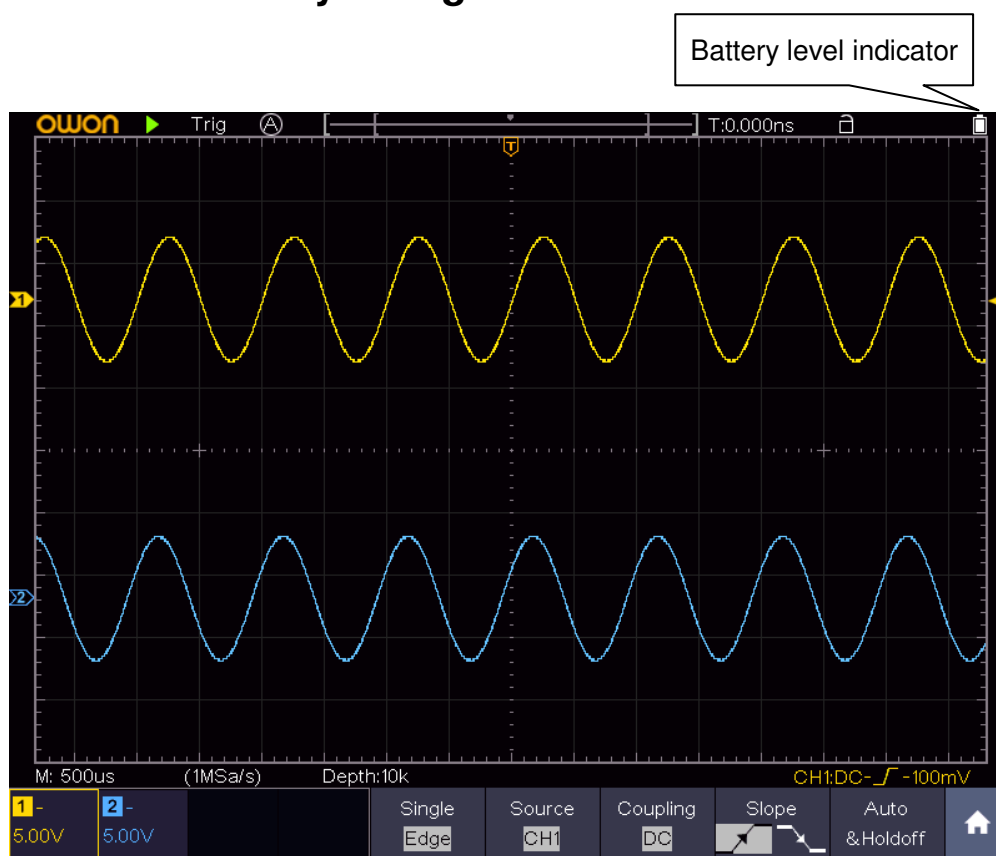

Figure 11-1 Battery level indicator

Charging the oscilloscope

There will have battery power indication show on the top of panel when oscilloscope power supplied by the battery (if no indication has appeared, see "*Display*" on P51).

□ indicates the battery is nearly used up.

Note:

To avoid overheat of battery during charging, the ambient temperature is not allowed to exceed the permissible value given in technical specification.

Replacing the Lithium Battery Unit

It is usually not required to replace the battery unit. But when it is required to replace it, only qualified personnel can carry out this operation, and only use the same specification lithium battery.