



49" HIGH BRIGHTNESS 5,500 NITS LCD WITH NARROW BEZEL

The DS491LT6 is a full HD 49-inch high brightness LCD producing a 5,500 nit sunlight viewable image. The DS491LT6 has been designed for applications in bright environments such as outdoor enclosures and storefront windows.

A narrow 8.5 mm bezel makes this model ideal for either single display or video wall applications. Each screen is individually color calibrated to the D65 color standard to ensure uniformity among multiple displays.

The DS491LT6 features an integrated Android™ based media player with WiFi offering users a complete media platform, allowing playback of local files and USB/SD card media.



SUNLIGHT
VIEWABLE



NARROW
BEZEL



ANDROID
OS



POLARIZED
LENSES OK

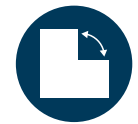

PORTRAIT &
LANDSCAPE

APPLICATIONS

- **STORE FRONT WINDOWS**
- **TRANSPORTATION**
- **FINANCIAL INSTITUTIONS**
- **OUTDOOR ENCLOSURES**
- **DIGITAL ADVERTISING**

SPECIFICATIONS

PANEL	LCD Panel Type	48.5 inches LCD
	Native Resolution	1920 x 1080
	Backlight	LED
	Brightness	5500 nit
	Default Color Temperature	D65 (6500 K)
	Contrast Ratio	3,000:1
	Color Depth	10 bit
	Response Time	8 ms (typ)
	Viewing Angle	178° / 178°
	Light Life Time	100,000 hrs (typ.)
	Blackening Defect Free	Up to 110°C (230°F)
	Panel Surface	AR, Haze <2%, 2H, QWP
POWER	Power Supply	Internal
	Rated Voltage	100 V ~ 240 V, 50 Hz / 60 Hz
	Power On Mode	185 W (typ), 340 W (max)
	Power Saving Mode	< 1 W
MECHANICAL	Bezel Width (T/B/L/R)	8.7 / 8.7 / 8.5 / 8.5 mm
	Cabinet Color	Black
	Monitor Dimension (LxHxD)	1096.7 x 627.2 x 82.5 mm [43.1" x 24.7 x 3.2"]
	Monitor Weight (set/package)	20.9 kg / 28.0 kg [46 lb / 62 lb]
	VESA Mounting (dimension)	400 x 400 mm
	Orientation	Portrait / Landscape
USER INTERFACE	Language	English
	Daisy Chain	DVI, RS-232
	Video Wall	Up to 15 x 15
	Proof of Image Retention	Yes
	Dimming Control (DCR)	Yes
	On/Off Scheduling	Yes
	Ambient Light Sensor	Yes
	External Control	RS-232 (In/Out), RJ45
	Internal Temperature Sensor	Yes
I/O PORTS	HDMI	In (x1), Out (x1)
	DVI-D	In (x1)
	DisplayPort	In (x1)
	RS-232	In (x1), Out (x1)
	RJ-45	In (x1)
	Audio	Out (x1)
	USB 2.0	(x1)
	SD Slot	(x1)
ENVIRONMENT	Operating Temperature	0°C ~ 45°C (32°F ~ 113°F)
	Storage Temperature	-20°C ~ 60°C (-4°F ~ 140°F)
	Humidity	10% ~ 80% RH Non-condensing
ACCESSORIES	Included	Quickstart guide, Power cable, Remote control with batteries
CERTIFICATION	CE / FCC Class B / ROHS	

DIMENSIONS

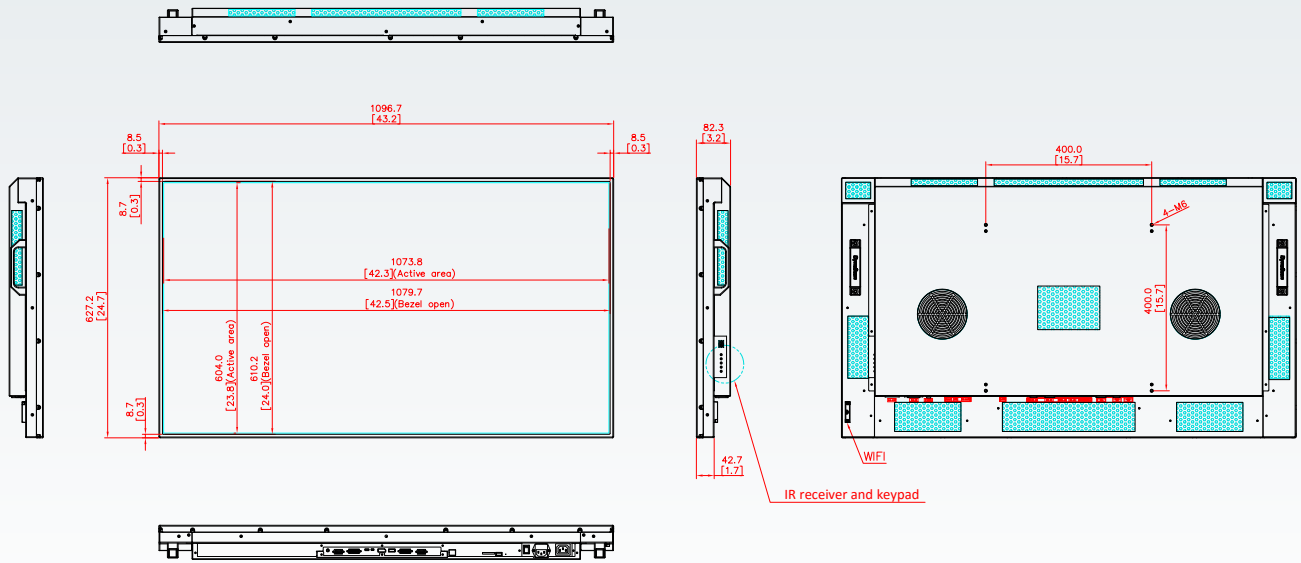

INTERNAL PLAYER

INTERNAL PLAYER	Operating System	Android 4.4.2
	Processor	ARM Cortex-A9 1.6 GHz, Quad-Core CPU
	On Chip Cache Memory	L2: 512KB
	Clock Speed	1.6 GHz
	Main Memory Interface	1GB DDR3/3L (1600MHz)
	Graphics	600M ARM Mali400MP4,2D/3D graphic engine, support OpenGL ES1.1/2.0, Open VG1.1
	Storage (FDM)	8GB NAND Flash(2GB occupied by o/s, 6GB available depending on total capacity)
	Multimedia	H.264 encoder/decoder, MPEG-1/2/4, H.263, H.264 MVC, AVS, VC-1, VP8/6, RV



FEATURES



Sunlight Viewable Image

With a 5,500 nit brightness rating, the display can easily be viewed in direct sunlight applications.



Blackening Defect-free

High Tni panel prevents blackening when exposed to high temperatures.



Viewable with Polarized Lenses

Utilizes quarter-wave plate technology to allow for viewing with polarized sunglasses.



24/7 Operation

Designed for worry-free round-the-clock operation.



True Color Calibration

Every display is factory calibrated to the D65 CIE color standard to produce a natural looking image.



Thermal Management

Heat generated by the display is radiated away from high temperature areas.



Automatic Brightness Control

A light sensor measures the ambient light in the area and automatically adjusts the image accordingly.



Brightness & Color Guaranteed

Guaranteed color and brightness degradation of no more than 9% over 5 years of continuous use.