

---

---

# **APOS**

# **Quick Operation Guide**

## **[ Voice Over IP ]**

**Release 1.00**

---

---

**AddPac Technology Co., Ltd**

**AddPac Technology R&D Center**



# [Contents]

---

<b>Chapter 1. Introduction.....</b>	<b>9</b>
<b>Overview .....</b>	<b>9</b>
Document History .....	9
Organization.....	10
<b>VoIP Products Covered .....</b>	<b>11</b>
VoIP Products Covered by This Guide.....	11
Obtaining Technical Assistance .....	12
AddPac Technology VoIP Internetworking Solution.....	13
<b>Chapter 2. Basic Equipment Management ..</b>	<b>14</b>
<b>Connecting a Terminal to VoIP Products .....</b>	<b>14</b>
Network Diagram .....	14
<b>User Account Management .....</b>	<b>15</b>
Log-in as Root.....	15
User Account Checking .....	16
Registering New User Account .....	16
Verifying New User Account .....	17
Log-in with new user account .....	17
Limited User Info Change .....	18
<b>Enable/ Disable Network Protocol .....</b>	<b>20</b>
Enabling/ disabling network protocols.....	20
<b>APOS Upgrade via FTP.....</b>	<b>21</b>
Network Diagram .....	22
FTP Service Status Checking .....	22
APOS download via FTP from PC .....	23
Upgraded APOS Image File Verification and Rebooting.....	24
<b>Boot Loader.....</b>	<b>25</b>
Network Diagram .....	25
Entering Boot Loader Mode.....	26
Checking Password.....	26
Password change and verification.....	27
IP Address Checking & Recovery .....	27
APOS Image File Download.....	28
APOS Configuration Initialization.....	29

## Chapter 3. VoIP Network Configuration..... 30

<b>PPPoE Network Application .....</b>	<b>30</b>
Network Diagram .....	30
Related APOS commands & structure .....	31
<b>DHCP Client Application .....</b>	<b>32</b>
Network Diagram .....	32
Related APOS commands & structure .....	32
<b>Fixed IP Application.....</b>	<b>34</b>
Network Diagram .....	34
Related APOS commands & structure .....	34
<b>Bridge Mode Application.....</b>	<b>36</b>
Network Diagram .....	36
Related APOS commands & structure .....	37
<b>NAT/PAT Environment Application .....</b>	<b>39</b>
Network Diagram of NAT Application .....	39
Network Diagram of PAT Application.....	40
APOS commands & structure .....	41
<b>IP Sharing Application .....</b>	<b>45</b>
Network Diagram .....	46
Related APOS commands & structure .....	47
<b>PAT Server (VoIP Gateway) Application.....</b>	<b>54</b>
Network Diagram .....	54
Related APOS commands & structure .....	55

## Chapter 4. VoIP Network Configuration..... 58

<b>Point-to-Point Application.....</b>	<b>58</b>
Network Diagram .....	58
Related APOS commands & structure .....	60
<b>Gatekeeper Interoperating Application.....</b>	<b>62</b>
Network Diagram .....	62
Related APOS commands & structure .....	65
<b>Number Translation Feature .....</b>	<b>68</b>
Network Diagram .....	68
Number Translation Example .....	69
Related APOS commands & structure .....	70
<b>Call Pickup &amp; Transfer Feature .....</b>	<b>72</b>
Network Diagram .....	72
Related APOS commands & structure .....	76

## Chapter 5. VoIP Protocol Configuration .....77

<b>VoIP Protocol</b> .....	<b>77</b>
<b>H.323 Protocol Application</b> .....	<b>77</b>
<b>SIP Protocol (Direct Call) Application</b> .....	<b>78</b>
Network Diagram .....	78
Related APOS commands & structure .....	79
<b>SIP Protocol (Indirect, Proxy Server) Application</b> .....	<b>81</b>
Network Diagram .....	81
Related APOS commands & structure .....	83
<b>Username/Password Registration of SIP Dial-Peer</b> .....	<b>84</b>
Related APOS commands & structure .....	85
<b>MGCP Protocol Application</b> .....	<b>86</b>
Network Diagram .....	86
Main APOS Commands for MGCP Protocol.....	86

## Chapter 6. Voice Interface Configuration...92

<b>Input &amp; Output Gain configuration</b> .....	<b>92</b>
Network Diagram .....	93
Related APOS commands & structure .....	93
<b>Tone Configuration</b> .....	<b>95</b>
Network Diagram .....	95
Related APOS commands & structure .....	96
<b>E1/T1 Voice Interface Configuration/ ISDN-PRI</b> .....	<b>98</b>
Network Diagram .....	98
Related APOS commands & structure .....	100
<b>E1/T1 Voice Interface Configuration/ R2 DTMF</b> .....	<b>102</b>
Network Diagram .....	102
Related APOS commands & structure .....	104
<b>FXS/FXO Voice Interface configuration for caller ID</b> .....	<b>105</b>
Network Diagram .....	105
Related APOS commands & structure .....	107
<b>FXS/FXO Voice Interface configuration for polarity-inverse</b> .....	<b>109</b>
Network Diagram .....	109
Related APOS commands & structure .....	111
<b>E&amp;M Voice Interface Configuration</b> .....	<b>112</b>
Network Diagram .....	112
Related APOS commands & structure .....	114

---

<b>Chapter 7. Appendix.....</b>	<b>115</b>
<b>E&amp;M Voice Interface Dip Switch setting.....</b>	<b>115</b>
E&M Voice Interface Module Jumper Switch .....	115
E&M Voice Interface Jumper Switch Description .....	116
<b>E&amp;M Voice Interface Type and Jumper Setting .....</b>	<b>117</b>
<b>E&amp;M Voice Interface Wire Type and Jumper Setting .....</b>	<b>118</b>
2-Wire E&M Voice Interface Jumper Setting .....	118
4-Wire E&M Voice Interface Jumper Setting .....	118
<b>Glossary.....</b>	<b>119</b>

## [Table of Tables]

[Table 1-1] History of APOS Quick Operation Guide.....	9
[Table 1-2] APOS Quick Operation Guide Organization.....	10
[Table 1-3] VoIP products covered by APOS Quick Operation Guide .....	11

## [Table of Figures]

Fig. 1-1 AddPac Technology VoIP Internetworking Solution.....	13
Fig. 2-1 VoIP gateway log-in.....	14
Fig. 2-2 APOS image file upgrade via FTP .....	22
Fig. 2-3 Network diagram for boot loader mode access .....	25
Fig. 3-1 VoIP network diagram on ADSL Network.....	30
Fig. 3-2 VoIP network diagram on DHCP network.....	32
Fig. 3-3 VoIP network diagram on fixed IP Network.....	34
Fig. 3-4 VoIP network diagram of Ethernet Bridge Network .....	36
Fig. 3-5 VoIP network diagram of NAT application.....	39
Fig. 3-6 VoIP network diagram of PAT application .....	40
Fig. 3-7 VoIP network diagram of IP sharing application .....	46
Fig. 3-8 VoIP network diagram of VoIP gateway operating as PAT server.....	54
Fig. 4-1 VoIP network diagram of peer-to-peer communication .....	58
Fig. 4-2 VoIP network diagram of Gatekeeper interoperating application.....	62
Fig. 4-3 VoIP gateway number translation feature diagram.....	68
Fig. 4-4 VoIP gateway Call-pickup feature .....	72
Fig. 4-5 VoIP gateway Call-transfer feature .....	73
Fig. 5-1 VoIP network diagram of SIP direct call configuration.....	78
Fig. 5-2 VoIP network diagram of SIP indirect calls via SIP Proxy server .....	81
Fig. 5-3 VoIP network diagram based on MGCP protocol.....	86
Fig. 6-1 VoIP Gateway Input/Output gain .....	93
Fig. 6-2 VoIP gateway tone setting .....	95
Fig. 6-3 VoIP gateway digital E1/T1 ISDN-PRI.....	98
Fig. 6-4 VoIP gateway digital E1/T1 R2/DTMF.....	102
Fig. 6-5 VoIP gateway caller- ID feature.....	105
Fig. 6-6 VoIP gateway polarity inverse feature on FXS port.....	109
Fig. 6-7 VoIP gateway polarity inverse feature on FXO port.....	110
Fig. 6-8 VoIP gateway E&M interface .....	112
Fig. 7-1 E&M voice interface module jumper switch image.....	115
Fig. 7-2 E&M voice interface module front view .....	116



---

---

# Chapter 1. Introduction

---

---

## Overview

**APOS** (AddPac Internetworking Operating System) Quick Operation Guide provides information on APOS commands & structure, popular network diagram and configuration verification/debugging commands of AddPac's VoIP (Voice over IP) products including VoIP Gateway.

Especially, the network diagram and APOS commands of this guide are real examples which can be applied to the users' applications. For more detailed information of APOS commands, refer to **APOS Operation Guide**.

## Organization

Table 1-2 provides an overview of the organization of this guide.

**[Table 1-2] APOS Quick Operation Guide Organization**

Chapter	Title	Description
Chapter 1	Overview	Provides the overview of APOS Quick Operation Guide, History and VoIP products covered
Chapter 2	Device & Network Management	Provides information on VoIP device login, Password, APOS image file downloading and recovery
Chapter 3	VoIP Network Environment	Provides information about configuring various VoIP network types and APOS commands.
Chapter 4	VoIP Network Configuration	Provides information about APOS configuration on various VoIP networks and the configuration examples.
Chapter 5	VoIP Protocol Configuration	Provides information about APOS configuration of H.323, SIP and MGCP protocols and various configuration examples
Chapter 6	Voice Interface Configuration	Provides information about APOS configuration of FXS, FXO, E&M & digital E1/T1 Interface
Chapter 7	Appendix	Provides information on how to set dip switch for E&M voice interface module and the glossary of network terms

# VoIP Products Covered

## VoIP Products Covered by This Guide

APOS Quick Operation Guide covers AddPac's VoIP products listed at [Table 1-3]. You can refer to this guide for VoIP router, Multi-service router, gatekeepers, broadcasting over IP system, Fax broadcasting system along with VoIP gateway. The provided network diagram, configuration examples, APOS commands and descriptions are based on VoIP gateway products. For VoIP network application and APOS commands that are not mentioned at this guide, please contact AddPac Technology R&D Center.

**[Table 1-3] VoIP products covered by APOS Quick Operation Guide**

Product Line	Models	Main Network Interface
VoIP gateway	<b>AP160</b>	FXS voice port PSTN Dial-up port Ethernet port
	<b>AP200 Series</b>	FXS/FXO voice port Ethernet port
	<b>AP1000 Series</b>	FXS/FXO voice port Ethernet port
	<b>AP1100 Series</b>	FXS/FXO voice port Ethernet port
	<b>AP2110</b>	FXS/FXO/E&M voice interface module Digital E1/T1 interface module Ethernet port
	<b>AP2120</b>	FXS/FXO/E&M voice interface module Ethernet port
	<b>AP3100</b>	FXS/FXO/E&M voice interface module Ethernet port
	<b>AP2520G</b>	FXS/FXO/E&M voice interface module Digital E1/T1 interface module Ethernet port
Secure VoIP gateway	<b>AP2520S</b>	FXS/FXO/E&M voice interface module Ethernet port
VoIP router	<b>AP2520R</b>	FXS/FXO/E&M voice interface module Digital E1/T1 interface module Ethernet port
Multi-service router	<b>AP2830</b>	FXS/FXO/E&M voice interface module Digital E1/T1 interface module Network interface module (Ethernet port)
	<b>AP2850</b>	FXS/FXO/E&M voice interface module Digital E1/T1 interface module Network interface module (Ethernet port)
Built-in gatekeeper	<b>AP-GK1000</b>	Ethernet interface
	<b>AP-GK2000</b>	Ethernet interface
	<b>AP-GK3000</b>	Ethernet interface
Broadcasting over IP system	<b>AP3120</b>	Ethernet interface
Fax broadcasting system	<b>AP3220</b>	Ethernet interface

## Obtaining Technical Assistance

AddPac's Technical Assistance is available to all customers and partners. The technical supports and training of this APOS Quick Operation Guide and AddPac Products can be obtained from Monday through Friday (9:00 AM ~ 7: PM, GMT+9:00). Also, technical support via e-mail is available around the clock.

### **AddPac Technology Tech Support Center**

TEL: +82-2-568-3848, FAX +82-2-568-3847

E-mail: [products@addpac.com](mailto:products@addpac.com)

# AddPac Technology VoIP Internetworking Solution

AddPac Technology's VoIP Internetworking solution offers high performance networking solution not only for voice but also for data, image and multimedia network applications. The below figure shows the overall AddPac's VoIP products and networking solutions.

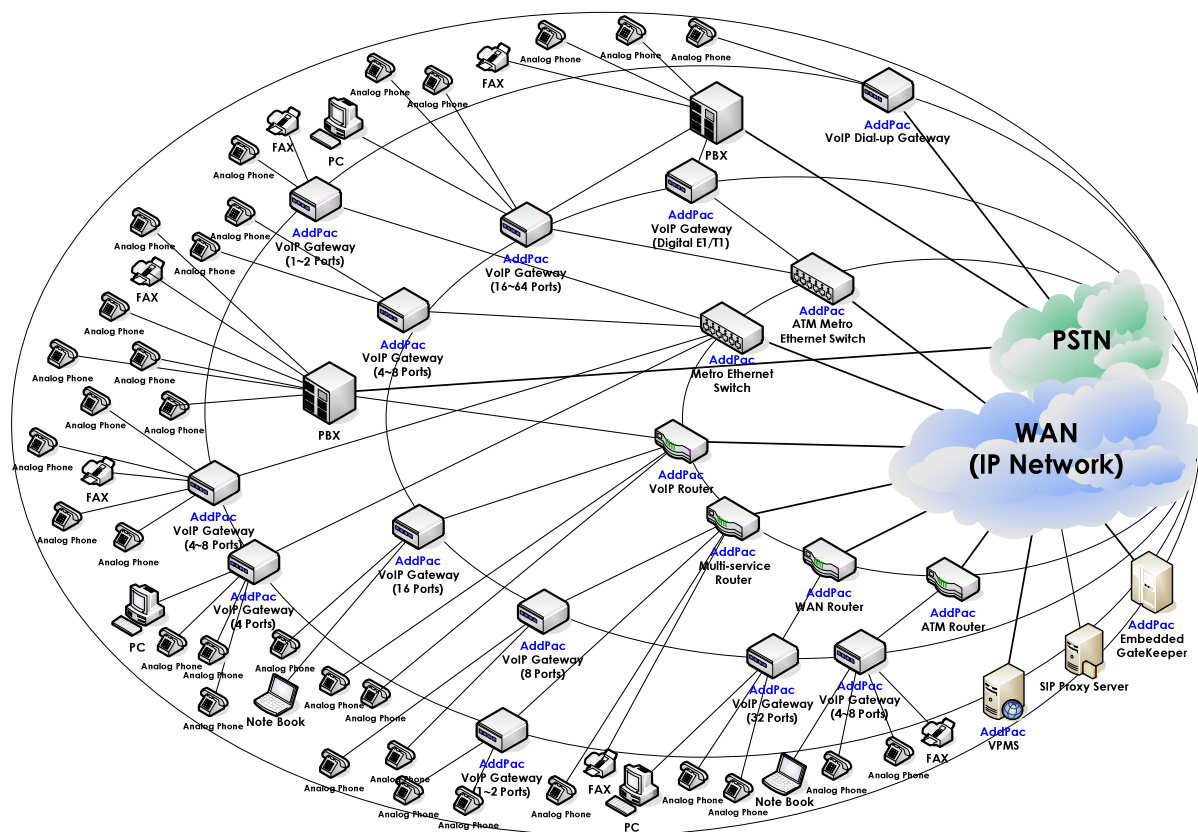

Fig. 1-1 AddPac Technology VoIP Internetworking Solution

---

---

## Chapter 2. Basic Equipment Management

---

---

This chapter provides the information on APOS commands regarding basic equipment management features of VoIP products including VoIP gateway.

---

**NOTE** Basic Equipment Management is supported by AddPac Technology's all VoIP products along with VoIP Gateway.

---

### Connecting a Terminal to VoIP Products

Two different access types are available for connecting a terminal to VoIP products. One is using PC's Hyper terminal emulation program via RS-232C console port of the VoIP gateway. Also, the other is accessing via Ethernet using telnet program.

The user interface and APOS commands are identical at both cases.

#### Network Diagram

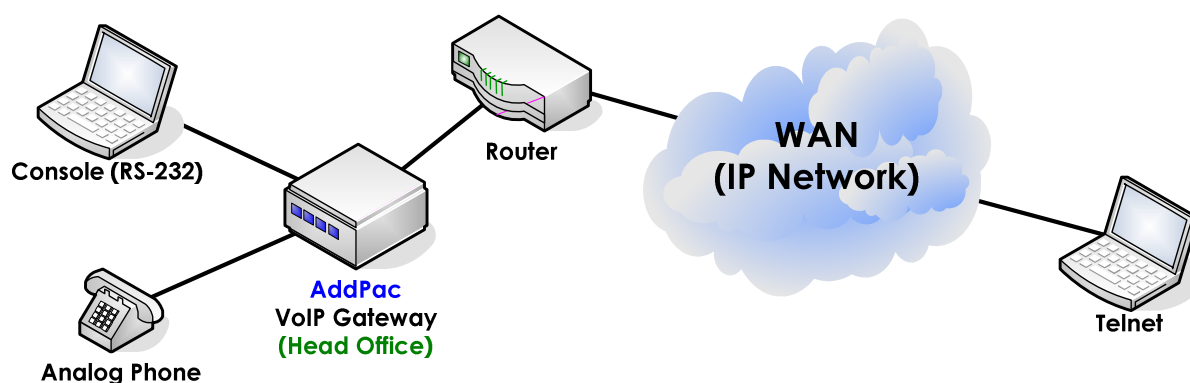

Fig. 2-1 VoIP gateway log-in

## User Account Management

VoIP gateway log-in user account and its permission level can be managed with user account management feature. According to the permission level of an account, the available APOS commands are different. The general rules applied to the user account including “root” account are as shown below.

- The “root” user account is undeletable.
- The “root” user account can check the information of all user accounts
- Even though the user level is “Admin”, it can only check its own information, if it is not “root” user.

Only the “root” user is allowed to add or delete user accounts. Note that the permission level of the “root-Admin” and the “Admin” created by “root” are different.

---

**NOTE** The default password of all AddPac's products including VoIP gateway at shipment is “router”

---

### Log-in as Root

Step	Commands	Description
1	The System is ready. Please login to system. login: login: <b>root</b>	Log-in as “root”.
2	password: <password> AP1100-S404 - Login : root at Console on Tue Oct 28 13:01:58 2003 #	Enter the default password “router.” Enter APOS global configuration mode.

## User Account Checking

Step	Commands	Description
1	# # <b>show user</b>	Check the user account information.
2	Login Name    Password    User level    Timeout    Alias Name ----- root            router        ADMIN        0 #	

## Registering New User Account

Step	Commands	Description
1	# # <b>config</b> Enter configuration commands, one per line. End with CNTL/Z	Enter APOS global configuration mode.
2	(config)# (config)# <b>user ?</b> add            Add new user at User entry change        Change User's Password level         Change User's Access Level timeout       Change User's auto logout time	"?" shows the available options.
3	(config)# (config)# <b>user add addpac1?</b> <password> Password for given login	
4	(config)# (config)# <b>user add addpac1 addpac1 ?</b> admin , high, normal or low	
5	(config)# (config)# <b>user add addpac1 addpac1 admin</b>	Create a user account of user ID "addpac1", password "addpac1" and level "admin."
6	(config)# (config)# <b>user add addpac2 addpac2 high</b>	Create a user account of user ID "addpac2", password "addpac2" and level "high."
7	(config)# (config)# <b>user add addpac3 addpac3 normal</b>	Create a user account of user ID "addpac3", password "addpac3" and level "normal."



<b>8</b>	<pre>(config)# (config)# user add addpac4 addpac4 low</pre>	<p>Create a user account of user ID "addpac4", password "addpac4" and level "low."</p>
----------	---	--

## Verifying New User Account

Step	Commands	Description
<b>1</b>	<pre># # show user</pre>	<p>Verify the newly added user account information.</p>
<b>2</b>	<pre>Login Name      Password      User level    Timeout    Alias Name ----- root            router        ADMIN         0 addpac1         addpac1       ADMIN         0 addpac2         addpac2       HIGH          0 addpac3         addpac3       NORMAL        0 #</pre>	

## Log-in with new user account

Step	Commands	Description
<b>1</b>	<pre># # exit  The System is ready. Please login to system.  login: login: addpac1</pre>	<p>Exit from the APOS system. Then log-in with the new user account.</p>
<b>2</b>	<pre>password: &lt;password&gt; AP1100-S404 - Login : root at Console on Tue Oct 28 13:01:58 2003 # #</pre>	<p>Enter the new password "addpac1."</p>
<b>3</b>	<pre># # show user  Login Name      Password      User level    Timeout    Alias Name ----- addpac1         addpac1       ADMIN         0 # #</pre>	<p>Only the account information of itself can be viewed and verified.</p>

## Limited User Info Change

Step	Commands	Description
1	# # <b>exit</b> The System is ready. Please login to system. login: login: <b>addpac1</b>	Exit from the APOS system. Then log-in with the new user account.
2	password: <password> AP1100-S404 - Login : root at Console on Tue Oct 28 13:01:58 2003 #	Enter the new password "addpac1."
3	# # <b>user change?</b> <login-name> Login name of user entry # <b>user change</b>	"?" shows the available options of "user change" command.
4	# <b>user change addpac1?</b> <old password> Old Password for given login # <b>user change addpac1</b>	
5	# <b>user change addpac1 addpac1?</b> <new password> New Password for given login # <b>user change addpac1 addpac1</b>	
6	# <b>user change addpac1 addpac1 addpac11</b> #	
7	# <b>user level?</b> <login-name> Login name of user entry # <b>user level</b>	
8	# <b>user level addpac1?</b> <password> Old Password for given login # <b>user level addpac1</b>	
9	# <b>user level addpac1 addpac11?</b> admin , high, normal or low	
10	# <b>user level addpac1 addpac11 low</b> This command is allowed only "root"	
11	# <b>user timeout?</b> <login-name> Login name of user entry # <b>user timeout</b>	
12	# <b>user timeout addpac1?</b>	

---

```
<timeout value> Time out value (second, 0 is  
forever)
```

```
# user timeout addpac1
```

---

```
13 # user timeout addpac1 120
```

```
#
```

---

## Enable/ Disable Network Protocol

AddPac Technology's VoIP products support various server application programs of the popular network protocols. The users can enable or disable certain server application programs.

There are seven server application programs: Easy Setup service, FTP & TFTP server, SNMP agent, HTTP server, Telnet server, NTP (Network Time Protocol). VoIP products enable three server application programs, FTP/HTTP/Telnet, as default at the initial booting process.

### Enabling/ disabling network protocols

Step	Commands	Description
1	# # <b>config</b>	Enter APOS global configuration mode.
2	(config)# <b>show service</b> Easy Setup Service : DISABLE FTP Server : ENABLE SNMP Agent : DISABLE TFTP Server : DISABLE HTTP Web Server : ENABLE TELNET Server : ENABLE (max session 5) NTP(Network Time Protocol) : DISABLE	Check the default status of server application programs. (Default setting at shipment)
3	(config)# (config)# <b>service snmp</b> Easy Setup Service : DISABLE FTP Server : ENABLE SNMP Agent : <b>ENABLE</b> TFTP Server : DISABLE HTTP Web Server : ENABLE TELNET Server : ENABLE (max session 5) NTP(Network Time Protocol) : DISABLE	Enable SNMP agent service.
4	(config)# (config)# <b>no service snmp</b> Easy Setup Service : DISABLE FTP Server : ENABLE SNMP Agent : <b>DISABLE</b> TFTP Server : DISABLE HTTP Web Server : ENABLE TELNET Server : ENABLE (max session 5) NTP(Network Time Protocol) : DISABLE	Disable SNMP agent service.

## APOS Upgrade via FTP

AddPac's VoIP products supports the below three network protocols for APOS binary code image file transfer. Also, each protocol can be turn on/off.

- **FTP (Supports server and client environment)**
- **TFTP (Supports server environment)**
- **HTTP (Supports server environment)**

Because it supports both FTP server and client applications, the file exchange between VoIP equipment is also supported. For the user name and password, refer to the user account list of the device.

As default, FTP, TFTP and HTTP server applications are enabled and this guide mainly deals with APOS image file upgrade via FTP, which known as very functional and reliable file transfer method.

For the latest APOS image, release notes, installation guides and APOS quick operation guides including this guide, visit AddPac Technology's website at [www.addpac.com](http://www.addpac.com).

Please check the server status before FTP file transfer.

FTP is an application protocol that uses the Internet's TCP/IP protocols, and downloading via RS-232C console interface is not available.

## Network Diagram

Before upgrading APOS image file, visit AddPac Technology's website, [www.addpac.com](http://www.addpac.com) and download the right APOS image to the PC. The network diagram upgrading APOS image from PC is as shown below.

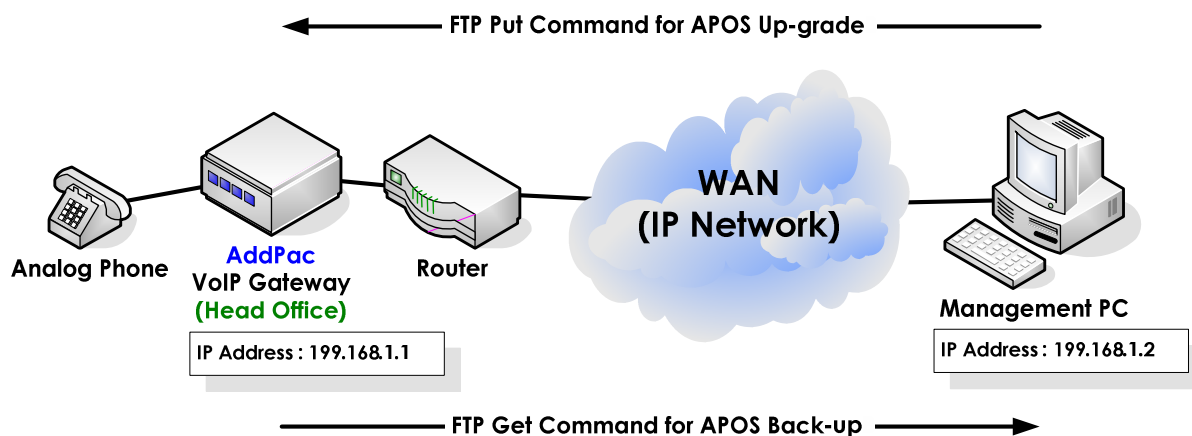

Fig. 2-2 APOS image file upgrade via FTP

## FTP Service Status Checking

Step	Commands	Description
1	# # config	Enter APOS global configuration mode.
2	(config)# show service Easy Setup Service : DISABLE FTP Server : ENABLE SNMP Agent : DISABLE TFTP Server : DISABLE HTTP Web Server : ENABLE TELNET Server : ENABLE (max session 5) NTP(Network Time Protocol) : DISABLE	Check the FTP server service status. (The default setting at shipment).

## APOS download via FTP from PC

Step	Commands on PC	Description
1	<pre>F:\test&gt; F:\test&gt;dir 2003-08-08 04:43p &lt;DIR&gt; . 2003-08-08 04:43p &lt;DIR&gt; .. 2003-08-08 04:43p 1,142,532 ap1100rom_v6_120.bin 2 Files(s) 1,541,978 bytes 2 Dir(s) 5,221,683,200 byte free</pre>	Check the APOS image on PC.
2	<pre>F:\test&gt; F:\test&gt;ftp 192.168.1.2 Connected to 192.168.1.2. 220 router FTP server (Version 1.12) ready. User (192.168.1.2:(none)): root 331 Password required for root. Password:***** 230 User root logged in ok. F:\test&gt;</pre>	Access to the VoIP gateway via FTP.
3	<pre>ftp&gt;bin 200 Type set to I.</pre>	Set the APOS image as binary.
4	<pre>ftp&gt; put ap1100 rom_v6_120.bin 200 PORT command successful. 150 BINARY data connection for ap1100rom_v6_120.bin (194.168.1.2,1826). 226 BINARY Transfer complete. 1142532 bytes sent in 1.06 seconds (1075.83 Kbytes/sec)</pre>	Upgrade APOS image from PC to VoIP gateway with "PUT" command.
5	<pre>ftp&gt; quit F:\test&gt; F:\test&gt;</pre>	Exit from FTP mode.

## Upgraded APOS Image File Verification and Rebooting

Step	Commands on PC	Description
1	login: login: root	Log in as root
2	password: **** AP1100 - Login : root at Console on Wed Aug 20 06:14:38 2003 #	Enter the password.
3	# show files	Verify the upgraded image.
	<pre>-rwxrwxrwx 1 noone nogroup 0 Oct 30 2003 evtlog0.txt -rwxrwxrwx 1 noone nogroup 0 Oct 30 2003 evtlog0.txt -rwxrwxrwx 1 noone nogroup 0 Oct 30 2003 cmdlog0.txt -rwxrwxrwx 1 noone nogroup 0 Oct 30 2003 cmdlog1.txt -rwxrwxrwx 1 noone nogroup 1368 Oct 30 2003 config.cfg -rwxrwxrwx 1 noone nogroup 2605964 Oct 30 2003 ap1100rom_v7_00.bin #</pre>	
4	# reboo	Reboot the system after verifying the Image.
	<pre>System Reboot...  System Boot Loader, Version 1.4.5/2 Copyright (c) by AddPac Technology Co., Ltd. Since 1999.  System Bootstrap, Version 1.2 Decompressing the image: ##### ##### ##### ##### ##### [t</pre>	



## Boot Loader

APOS image and password recovery and change are required at the below conditions.

- **The password of root account is changed or lost**
- **APOS image file is deleted or damaged**

The users can restore or check the password at the boot loader mode. Also, when APOS image is damaged or deleted, you can download the image at the boot loader mode.

---

**NOTE** In boot loader mode, IP routing feature is not available. So the Ethernet IP address of the PC with the OS image and that of the VoIP gateway should be on the same network.

---



---

**NOTE** To enter boot loader mode, establish direct access to the gateway via console port.

---

## Network Diagram

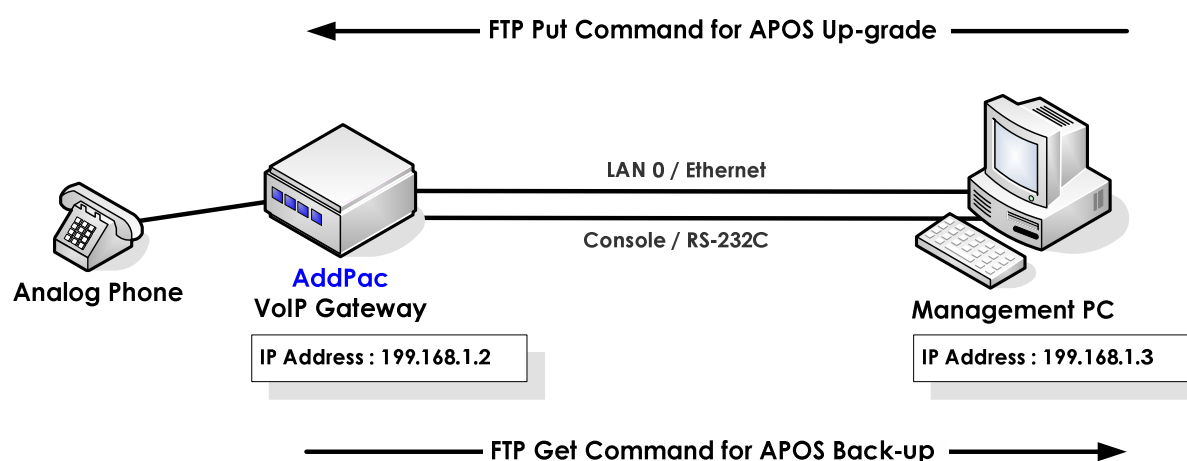

Fig. 2-3 Network diagram for boot loader mode access

## Entering Boot Loader Mode

Step	Commands	Description
1	<pre># # reboot System Reboot...  System Boot Loader, Version 1.4.5/2 Copyright (c) by AddPac Technology Co., Ltd. Since 1999.</pre>	Restart the system by H/W reset (Power switch off/on) or S/W reset (reboot command).
2	<pre>The "BOOT LOADER" is ready  BOOT# BOOT#</pre>	When the initial message is displayed, press "ctrl-C" & "ctrl-X" by turns. Then the VoIP gateway enters boot loader mode.
3	<pre>BOOT# ? configure  Enter configuration mode erase      Easy Erase configuration data exit       Exit from the EXEC history    Show command line history ping       Send echo messages reboot     reboot system show       Show running system information telnet     Open a telnet connection BOOT#</pre>	Check the commands supported at the boot loader mode.

## Checking Password

Step	Commands	Description
1	<pre>BOOT# BOOT# show password Password = "router" BOOT#</pre>	Check the current password.

## Password change and verification

Step	Commands	Description
1	<pre> BOOT# BOOT# <b>config</b> BOOT(config)# </pre>	Enter the boot loader command mode.
2	<pre> BOOT(config)# BOOT(config)# <b>password abcd abcd</b> password change BOOT(config)# </pre>	Enter the new password twice to change the password.
3	<pre> BOOT(config)# BOOT(config)# <b>exit</b> BOOT# </pre>	Exit from the boot loader command mode.
4	<pre> BOOT# BOOT# <b>show password</b> Password = "abcd" BOOT# </pre>	Verify the newly configured password.

## IP Address Checking & Recovery

Step	Commands	Description
1	<pre> BOOT# BOOT# <b>show interface</b> Interface Configuration : ether0.0 IP address : 172.17.103.10 netmask : 255.255.0.0 mtu = 1500 Ethernet Address : 00 02 a4 ff ff 1a Ethernet0 is DOWN, Line protocol is DOWN Bandwdith : 10000 Kbit   Operating mode : HALF-DUPLEX   Operating speed : 10 Mbps   0 packets input, 0 bytes, 0 no buffers   Received 0 runts, 0 giants   0 input errors, 0 CRC, 0 frame, 0 overrun, 0 ignored   0 input packets with dribble condition detected   0 packets output, 0 bytes, 0 drops   0 output errors, 0 collision, 0 interface resets   0 underruns, 0 late collisions, 0 deferred   0 lost carrier, 0 no carrier BOOT# </pre>	Check the interfaces, statistical information and the IP address assigned on the Ethernet interface 0.0.
2	<pre> BOOT# <b>config</b> BOOT(config)# <b>address 192.168.1.2 255.255.255.0</b> </pre>	Assign the IP address to the interface.

<b>3</b>	<pre> BOOT(config)# BOOT(config)# <b>exit</b> BOOT# </pre>	Exit from the boot loader command mode.
<b>4</b>	<pre> BOOT# BOOT# <b>show interface</b> Interface Configuration : ether0.0 IP address : 192.168.1.2 netmask : 255.255.0.0 mtu = 1500 Ethernet Address : 00 02 a4 ff ff 1a Ethernet0 is DOWN, Line protocol is DOWN Bandwidth : 10000 Kbit   Operating mode : HALF-DUPLEX   Operating speed : 10 Mbps   0 packets input, 0 bytes, 0 no buffers   Received 0 runs, 0 giants   0 input errors, 0 CRC, 0 frame, 0 overrun, 0 ignored   0 input packets with dribble condition detected   0 packets output, 0 bytes, 0 drops   0 output errors, 0 collision, 0 interface resets   0 underruns, 0 late collisions, 0 deferred   0 lost carrier, 0 no carrier BOOT# </pre>	Check the interfaces, statistical information and verifies the new IP address assigned on the Ethernet interface 0.0.

## APOS Image File Download

The APOS image file download procedure is same as that of APOS image upgrade via FTP. Please note that IP routing feature is not supported at the boot loader mode and this should be done at the same IP netmask. The IP address setting can be done at both the boot loader command mode and APOS command mode but the commands are not identical.

Step	Commands on PC	Description
<b>1</b>	<pre> F:\test&gt; F:\test&gt;<b>dir</b> 2003-08-08  04:43p  &lt;DIR&gt;          . 2003-08-08  04:43p  &lt;DIR&gt;          .. 2003-08-08  04:43p                1,142,532  apl1100rom_v6_120.bin                 2 Files(s)                1,541,978  bytes                 2 Dir(s)          5,221,683,200  byte free </pre>	Check the APOS image on PC.
<b>2</b>	<pre> F:\test&gt; F:\test&gt;<b>ftp 192.168.1.2</b> Connected to 192.168.1.2. 220 router FTP server (Version 1.12) ready. User (192.168.1.2:(none)): root 331 Password required for root. </pre>	Access to the VoIP gateway via FTP.

---

	<pre> Password:***** 230 User root logged in ok. F:\test&gt; </pre>	
<b>3</b>	<pre> ftp&gt;bin 200 Type set to I. </pre>	Set the APOS image as binary.
<b>4</b>	<pre> ftp&gt; put ap1100 rom_v6_120.bin 200 PORT command successful. 150 BINARY data connection for ap1100rom_v6_120.bin (194.168.1.2,1826). 226 BINARY Transfer complete. 1142532 bytes sent in 1.06 seconds (1075.83 Kbytes/sec) </pre>	Upgrade APOS image from PC to VoIP gateway with "PUT" command.
<b>5</b>	<pre> ftp&gt; quit F:\test&gt; F:\test&gt; </pre>	Exit from FTP mode.

---

## APOS Configuration Initialization

At boot loader mode, the default APOS configuration can be restored.

Step	Commands	Description
<b>1</b>	<pre> BOOT# BOOT# erase Do you want to ERASE configuration ? [y n] y Erasing configuration...done BOOT# </pre>	Restore the default APOS configuration at the boot loader command mode.

---

# Chapter 3. VoIP Network Configuration

This chapter provides information on network interface configuration of VoIP products (ex. VoIP gateway, router and etc.). These are real network application examples which can be applied to general customer environment. Before you begin, carefully review this chapter.

## PPPoE Network Application

PPPoE application is for the users of PPPoE broadband network environment using ADSL modem.

**NOTE** PPPoE Network Application is supported by AddPac Technology's all VoIP products along with VoIP gateway.

### Network Diagram

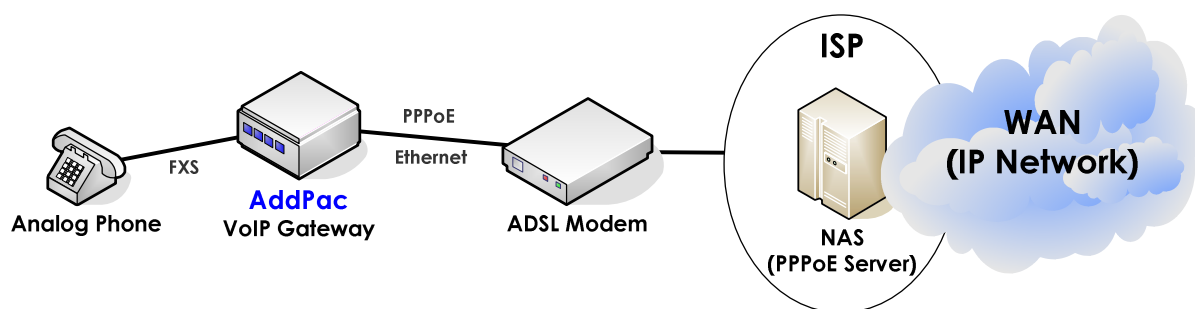

Fig. 3-1 VoIP network diagram on ADSL Network

#### APOS command script

```
interface ether0.0
  no ip address
  encapsulation pppoe
  ppp authentication pap callin
  ppp pap sent-username addpac password 1234
  ppp ipcp ms-dns
  ppp ipcp default-route
!
```

## Related APOS commands & structure

Configure the below parameters appropriate for the network environment.

- Access ID: "**AddPac**"
- Access password: "**1234**"
- get DNS IP (option)
- get default-router IP (option)

To configure PPPoE network application, follow this procedure.

Step	Commands	Description
1	# # <b>config</b> Enter configuration commands, one per line. End with CNTL/Z (config)#	Enter APOS global configuration mode.
2	(config)# <b>interface ether0.0</b> (config-ether0.0)#	Enter the interface configuration mode.
3	(config-ether0.0)# <b>no ip address</b>	Do not assign an IP address to the interface.
4	(config-ether0.0)# <b>encapsulation pppoe</b>	Assign encapsulation type.
5	(config-ether0.0)# <b>ppp authentication pap callin</b>	Assign PAP as PPPoE authentication.
6	(config-ether0.0)# <b>ppp pap sent-username addpac password 1234</b>	Configure PAP User ID and Password. In this example, the user ID is "AddPac" and the password is "1234".
7	(config-ether0.0)# <b>ppp ipcp ms-dns</b>	Configure to get default router IP from PPP Server.
8	(config-ether0.0)# <b>ppp ipcp default-route</b>	Configure to get DNS IP from PPP Server.
9	(config-ether0.0)# <b>exit</b> (config)#	Exits from the interface configuration mode.
10	(config)# <b>exit</b> #	Exits from APOS global configuration mode.

# DHCP Client Application

DHCP Client application is for the users of the DHCP Server broadband network environment using Cable Modem.

**NOTE** DHCP Client Application is supported by AddPac Technology's all VoIP products along with VoIP Gateway.

## Network Diagram

At the below diagram, a VoIP gateway interoperates with Cable Modem, broadband networking equipment.

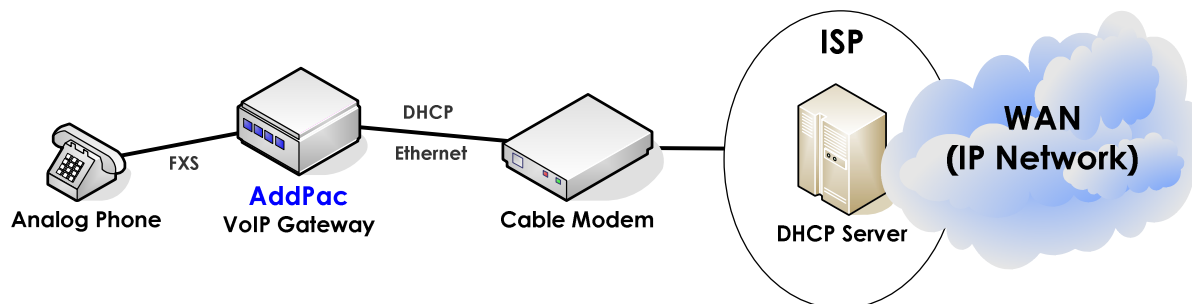

Fig. 3-2 VoIP network diagram on DHCP network

```

APOS command script
!
interface ether0.0
 ip address dhcp
!
```

## Related APOS commands & structure

No parameters are required for this application

Step	Commands	Description
1	# # <b>config</b> Enter configuration commands, one per line. End with CNTL/Z (config)#	Enter APOS global configuration mode.
2	(config)# <b>interface ether0.0</b>	Enter the interface configuration



---

	(config-ether0.0)#	mode.
<b>3</b>	(config-ether0.0)# <b>ip address dhcp</b> (config-ether0.0)#	DHCP server assigns the IP address.
<b>4</b>	(config-ether0.0)# <b>exit</b> (config)#	Exit from the interface configuration mode..
<b>5</b>	(config)# <b>exit</b> #	Exit from APOS global configuration mode.

---

## Fixed IP Application

On fixed IP environment, VoIP network includes WAN router. At least two Ethernet interfaces (LAN0, LAN1) are required for this application.

---

**NOTE** Fixed IP Application is supported by AddPac Technology's all VoIP products along with VoIP Gateway.

---

### Network Diagram

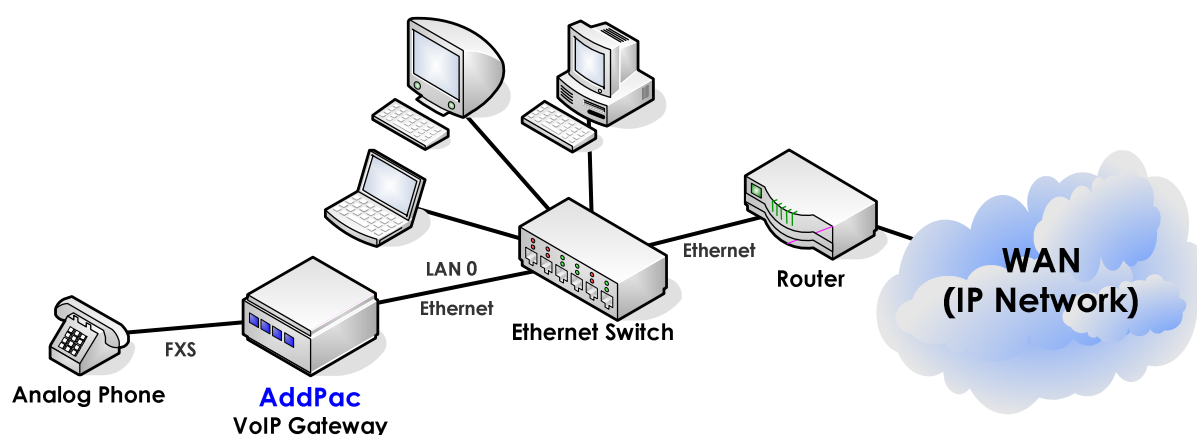

Fig. 3-3 VoIP network diagram on fixed IP Network

#### APOS command script

```
!
interface ether0.0
 ip address 192.168.1.2 255.255.255.0
!
 route 0.0.0.0 0.0.0.0 192.168.1.1
!
```

### Related APOS commands & structure

Configure the below parameters appropriate for the network environment.

- IP address for LAN 0 interface: **192.168.1.2**
- Net mask: **255.255.255.0**
- IP address of default router: **192.168.1.1**

To configure Fixed IP Application, follow this procedure.

Step	Commands	Description
1	# # <b>config</b> Enter configuration commands, one per line. End with CNTL/Z (config)#	Enter APOS global configuration mode.
2	(config)# <b>interface ether0.0</b> (config-ether0.0)#	Enter the interface configuration mode.
3	(config-ether0.0)# <b>ip address 192.168.1.2 255.255.255.0</b>	Assign the IP address to the interface.
4	(config-ether0.0)# <b>route 0.0.0.0 0.0.0.0 192.168.1.1</b>	Assign the default router.
5	(config-ether0.0)# <b>exit</b> (config)#	Exit from the interface configuration mode.
6	(config)# <b>exit</b> #	Exit from APOS global configuration mode.

# Bridge Mode Application

Bridge mode is implemented when WAN Router environment (PPP, HDLC, Frame Relay, ATM and etc.) requires traffic priority control for the traffic from local network to IP network. Also, when the QoS feature of WAN Router is not sufficient and VoIP gateway should offer priority control between voice and data traffic, the bridge mode is recommended.

At least two Ethernet interfaces (LAN0, LAN1) are required for Bridge mode application.

---

**NOTE** Bridge Mode Application is supported by AddPac Technology's all VoIP products along with VoIP Gateway.

---

## Network Diagram

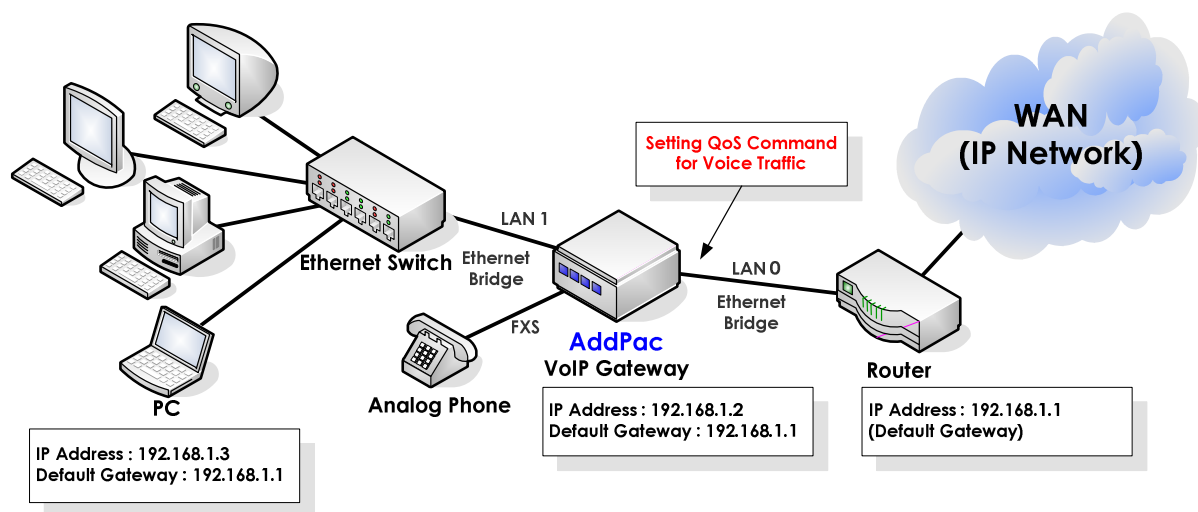

Fig. 3-4 VoIP network diagram of Ethernet Bridge Network

### APOS command script

```
!
no ip routing
!
no bridge spanning-tree
!
!
interface ether0.0
 ip address 192.168.1.2 255.255.255.0
 qos-control 200 150
 bridge
```

```

!
interface ether1.0
  no ip address
  bridge
!
route 0.0.0.0 0.0.0.0 192.168.1.1
!

```

## Related APOS commands & structure

At the above network diagram, the PC connected to LAN Switch regards VoIP Gateway as a transmission path. So the IP address of default router should be the Ethernet IP address of the Leased line router. Also, the VoIP Gateway only accepts the traffic which has the IP address of the VoIP gateway as the destination IP. The QoS is applied to Up-Link interface, so the priority and bandwidth control of all the traffic coming from the network under VoIP Gateway (LAN1) to the Internet (LAN 0) including VoIP traffic is possible.

Configure the below parameters appropriate for the network environment.

- IP address of the gateway: **192.168.1.2**
- Net Mask: **255.255.255.0**
- IP address of the default router: **192.168.1.1**
- Bridge mode for LAN 0 & LAN 1 interface
- QoS configuration for LAN0 interface
- No IP routing required

To configure bridge mode application, follow this procedure.

Step	Commands	Description
1	# # <b>config</b> Enter configuration commands, one per line. End with CNTL/Z	Enter APOS global configuration mode.
2	(config)# <b>no ip routing</b>	Disable IP routing features.
3	(config)# <b>no bridge spanning-tree</b>	No BPDU Exchange feature is required.
4	(config-ether0.0)# <b>interface ether0.0</b> (config-ether0.0)#	Enter the interface configuration mode.
5	(config-ether0.0)# <b>ip address 192.168.1.2 255.255.255.0</b>	Assign the IP address to the interface.

---

<b>6</b>	<code>(config-ether0.0)# qos-control 200 150</code>	Configure the QoS. Set the RX bandwidth and PPS as "20Kbps ~ 150Kpbs".
<b>7</b>	<code>(config-ether0.0)# bridge</code>	Activate the bridge mode for the interface.
<b>8</b>	<code>(config-ether0.0)# interface ether1.0</code> <code>(config-ether1.0)#</code>	Enter the interface configuration mode.
<b>9</b>	<code>(config-ether1.0)# no ip address</code>	No IP routing is required.
<b>10</b>	<code>(config-ether1.0)# bridge</code>	Activate the bridge mode for the interface.
<b>11</b>	<code>(config-ether1.0)# route 0.0.0.0 0.0.0.0</code> <code>192.168.1.1</code> <code>(config-ether1.0)#</code>	Assign the default router.
<b>12</b>	<code>(config-ether1.0)# exit</code> <code>(config)#</code>	Exits from the interface configuration mode.
<b>13</b>	<code>(config)# exit</code> <code>#</code>	Exits from APOS global configuration mode.

---

## NAT/PAT Environment Application

NAT(Network Address Translation) or PAT(Port Address Translation) environment of VoIP network is implemented when the IP based network (PPP, HDLC, Frame Relay, ATM and etc.) of WAN Router or IP sharer assigns private IP addresses to its local network. This part explains how to configure a gateway on a private network under IP sharer. NAT (Network Address Translation) Server and PAT (Port Address Translation) Server applications are explained below.

---

**NOTE** NAT/PAT Environment Application is supported by AddPac Technology's all VoIP products along with VoIP Gateway.

---

### Network Diagram of NAT Application

At NAT environment application, the WAN router or IP sharer connecting the VoIP gateway to exterior network has its own public IP Pool and dynamically converts a private IP to the public IP before the packets are forwarded onto the outside network.

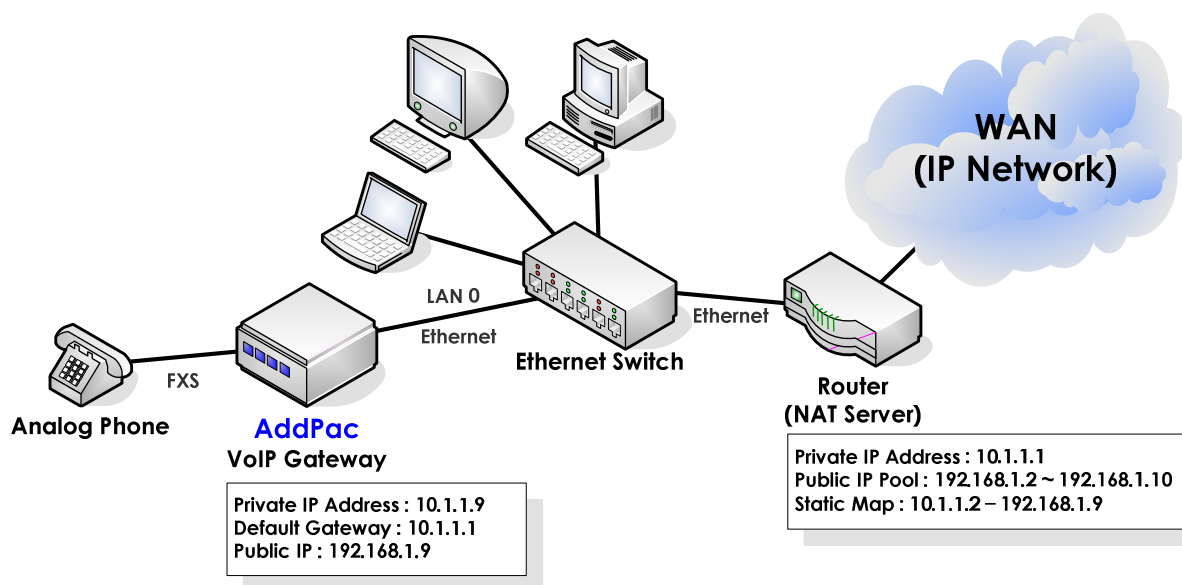

**Fig. 3-5 VoIP network diagram of NAT application**

However, when exterior network tries direct access to a specific

internal address, the public IP cannot address the private IP address matched. Then, the WAN router or IP sharer operates as NAT Server and it forcefully converts a private IP to one of the IP address at the its public IP Pool. That is, there is a call attempt from an exterior network to the gateway, the setup message can be reached to the internal IP because of the static map configured at the NAT Server.

### Network Diagram of PAT Application

At PAT environment application, the WAN router or IP sharer connecting the VoIP gateway to exterior network has a public IP address and dynamically assigns a public IP to the private IP forwarded to WAN.

However, NAT and PAT application is a little bit different. For NAT environment, number of public IP addresses can be mapped to number of private IP addresses. However, for PAT environment, only one public IP address is available.

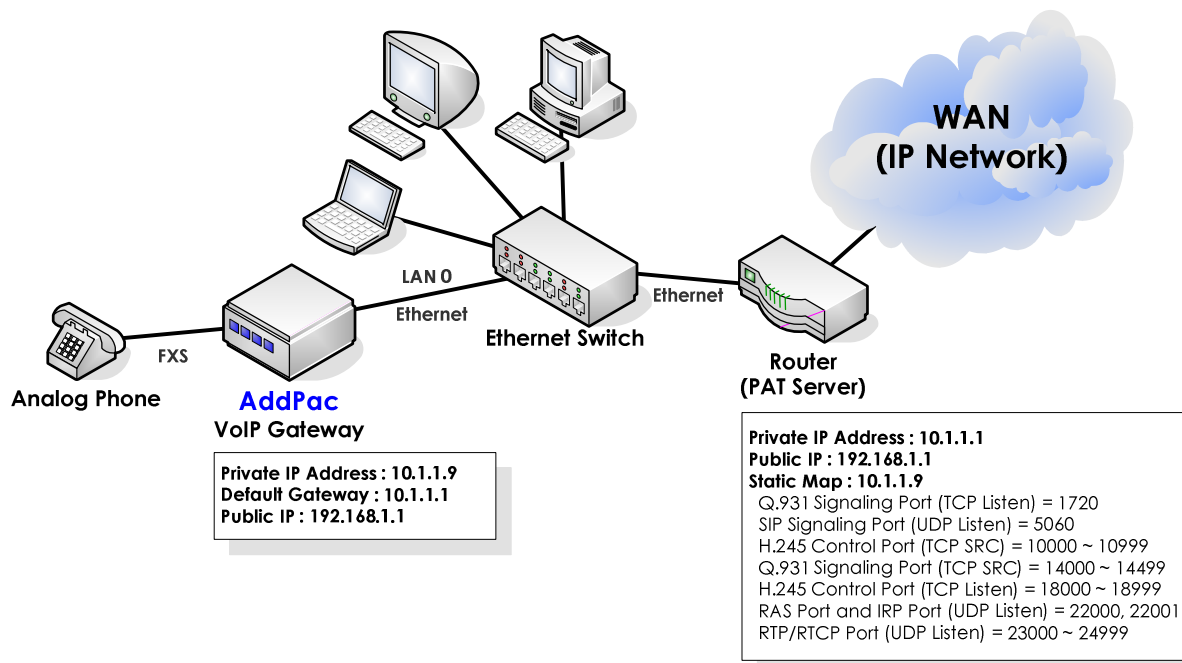

Fig. 3-6 VoIP network diagram of PAT application

PAT server shares one public IP address by offering dynamic mapping of local and remote TCP and UDP ports for the internal IPs forwarded to WAN. So more than one private IP addresses can



share one public IP address.

Same as NAT application, without this feature, there is a problem when exterior network tries direct access to a specific internal IP address. To solve this problem, Packets destined for an external address have their private IP address plus port number translated to the router's external IP address before the IP packet is forwarded to the WAN. When, there is a call attempt from an exterior network to the gateway, the setup message can be reached to the internal IP because of the static map configured at the PAT Server. The configuration is same as that of NAT Server.

## APOS commands & structure

To configure IP address on NAT/PAT environment, follow this procedure.

### Public IP address configuration under NAT/PAT environment

Step	Commands	Description
1	# # <b>config</b> Enter configuration commands, one per line. End with CNTL/Z (config)#	Enter APOS global configuration mode.
2	(config)# <b>gateway</b> (config-gateway)#	Enters gateway configuration mode.
3	(config-gateway)# <b>public-ip 192.168.1.9</b> (config-gateway)#	Configures the public IP address for NAT/ PAT application.
4	(config-gateway)# <b>exit</b> (config)#	Assign the IP address to the interface.
5	(config)# <b>exit</b> #	Exit from APOS global configuration mode.

## VoIP network under Firewall environment (VoIP Port Minimize)

The below configuration example is for the network environment with Firewall. Firewall restricts the number of TCP/UDP ports for communication. That's why it is necessary to reduce the number of ports used by VoIP gateway.

The number of TCP and UDP ports required by VoIP call connection is minimized. That is, the LISTEN and SOURCE ports of TCP and UDP packets can be configured.

Refer to the above configuration with the VoIP network of PAT Server application.

Step	Commands	Description
1	# # <b>config</b> Enter configuration commands, one per line. End with CNTL/Z (config)#	Enter APOS global configuration mode.
2	(config)# (config)# <b>voice service voip</b> (config-vservice-voip)#	Enter VoIP gateway configuration mode.
3	(config-vservice-voip)# (config-vservice-voip)# <b>minimize-voip-ports ?</b> multiply port pool = channel number x multiply service Assign port per each service (config-vservice-voip)#	
4	(config-vservice-voip)# (config-vservice-voip)# <b>minimize service ?</b> signal-tcp-src set H.225 signalling source port range control-tcp-src set H.245 control source port range control-tcp-listen set H.245 control listen port range rtp-udp-listen set RTP/RTCP port range	Configure the no. of ports. Configure the no. of ports. Configure the no. of ports. Configure the no. of ports.
5	(config-vservice-voip)# <b>exit</b> (config)#	Exit from the VoIP configuration mode.
6	(config)# <b>exit</b> #	Exit from APOS global configuration mode.

---

**NOTE** "Minimize multiply" and "minimize service command" cannot be configured at the same time. The configuration values can be overlapped.

---

### APOS command script (Configuration Verification)

```
(config)#  
(config)# voice service voip  
(config-vservice-voip)# minimize-voip-ports multiply 2  
(config-vservice-voip)# show gateway
```

#### System Information

```
status = init 2 (waiting for setting IP address on a VoIP interface)  
product name = AddPac VoIP  
product version = 7.00  
endpoint type = gateway
```

#### Gatekeeper Registration Information

```
H.323 id =  
gatekeeper registration option = disabled  
gatekeeper security option = disabled  
Gatekeeper registration status :  
not registered.  
last registration reject information from gatekeeper  
ConfigAsNoRegistration (Oct 30 18:25:20)
```

```
Gatekeeper list :
```

```
Local aliases
```

```
Technical prefixes
```

#### -- more -- Gateway Information

```
discovery (send GRQ) = disabled  
ARQ option = arq default  
LRQ option = no lrq  
lightweight IRR = disabled  
TTL margin = 20 %  
public ip = 192.168.1.9  
  
h323 call start mode = fast  
h323 call tunneling mode = enabled  
h323 call channel mode = late  
h323 response msg = default  
system fax mode = t38  
system fax rate (bps) = 9600  
system T.38 fax redundancy = 0  
force to send startH245 = enabled  
dialPeer hunt algorithm = longest - preference - random  
translate voip incoming called number = -1  
translate voip incoming calling number = -1  
local ringback tone = normal  
end of digit = #
```

---

---

```
ip address prefix = *
-- more --           permit unregistered h323 incoming call to FXO =
yes
voice confirmed connect on FXO/E&M = disabled

number of ports = 8
number of pots peers = 1
number of voip peers = 0
number of number expansions = 0
number of codec classes = 0
number of user classes = 0
number of alternate gatekeepers = 0
number of current calls = 0
```

#### Announcement Option

```
language = korean
element : delayed dial = disabled
element : wrong number = disabled
element : connection fail = disabled
element : enter password = disabled
element : pstn reroute = disabled
element : all lines busy = disabled
element : dial number = disabled

-- more --           Timer & Counter parameter value
tinit (initial digit timer) = 10 sec.
tring (ring timer) = 30 sec.
t301 (alert -> connect) = 180 sec.
t303 (setup -> alert) = 20 sec.
tras (RAS msg ack timer) = 6 sec.
tttl (RAS Time To Live timer) = 60 sec.
tidt (inter digit timer) = 3 sec.
treg (GK Registration retry timer) = 20 sec.
treg2 (GK Registration retry timer : long period by RRJ) = 120 sec.
tohd (On Hook Delay Time) = 0 sec.
tpoll (polling timer on trunk or polling type connection) = 180 sec.
dtmf duration = 150 msec.
dtmf guard time = 100 msec.
cras (RAS retry counter) = 3
```

#### Remote Call Log (syslog)

```
primary server =
secondary server =
interval = 0 minutes
cdr format type = 0

-- more --           Assigned VoIP TCP/UDP ports
minimized assign = yes
multiply = 2
Q.931 signalling port (TCP listen) = 1720
SIP signalling port (UDP listen) = 5060
H.245 control port (TCP src) = 10000 - 10015
Q.931 signalling port (TCP src) = 14000 - 14015
H.245 control port (TCP listen) = 18000 - 18015
RAS port and IRR port (UDP listen) = 22000, 22001
RAS GK src (UDP) port = 22002
RTP/RTCP port (UDP listen) = 23000 - 23031
```

---

## IP Sharing Application

In IP sharing application, the public IP address of VoIP gateway is shared with the devices of local network such as personal computers. It is different from NAT (network Address Translation)/PAT (Port Address Translation) converting the public IP address to private ones.

Currently, ordinary houses or SOHO users use dynamic or fixed IP for broadband Internet access. In case of dynamic IP address, a new IP address is assigned every time connecting Internet via ADSL Modem or Cable Modem. On the other hands, for the fixed IP Internet access, ADSL modem or dedicated line is assigned with fixed IP from ISP.

For dynamic IP access, VoIP Gateway is assigned with a dynamic & public IP address with PPPoE and DHCP application. Then the public IP is shared with the local network users. For fixed IP access, the fixed IP assigned by network service providers or ISPs is shared by the VoIP Gateway and the PC s of the local network.

With dynamic IP access, assign the dynamic IP to Ethernet 0.0 (LAN 0) and configure Ethernet 1.0 (LAN 1) as DHCP Server without assigning IP address. With fixed IP address, assign the IP to the Ethernet 0.0 (LAN 0) and do not assign IP address to Ethernet 1.0 (LAN 1).

For IP sharing function, more than two Ethernet Interfaces (LAN0, LAN1) are required.

---

**NOTE** IP Sharing Application is supported by AddPac Technology's all VoIP products along with VoIP Gateway.

---

## Network Diagram

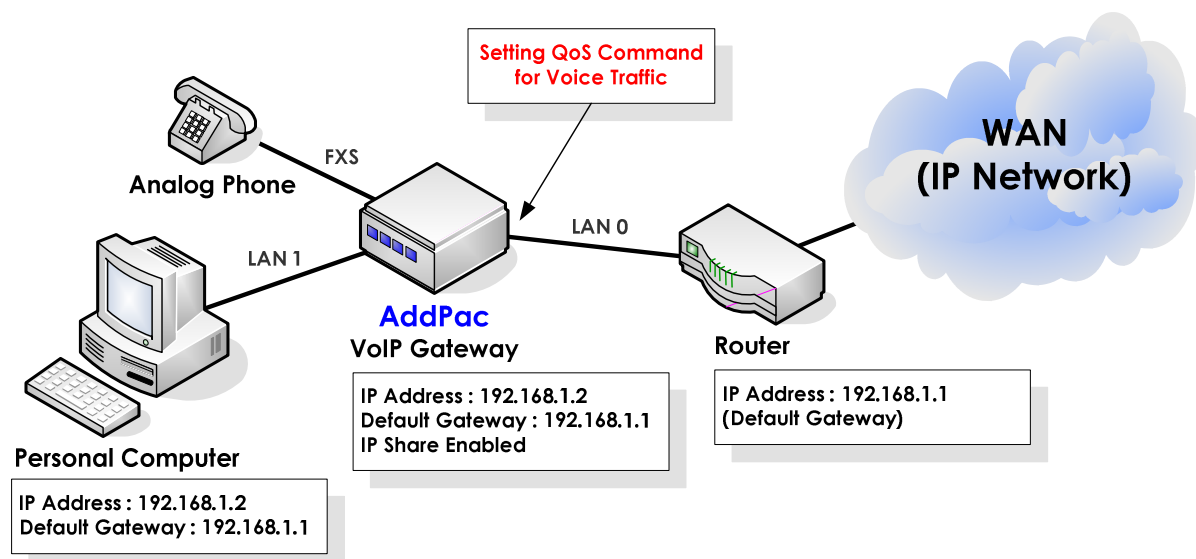

**Fig. 3-7 VoIP network diagram of IP sharing application**

At the view of packet transmission path, IP sharing is same as that of Bridge mode. QoS configuration of Ethernet 0.0 Interface (LAN 0) is required to allow higher priority for the voice traffic. With the QoS configuration, the VoIP Gateway can offer priority and bandwidth control for all the data coming through Ethernet 1.0 (LAN 1) and VoIP traffic as well, which realizes optimized voice quality.

Basically, changing existing user environment is not recommendable. So if the up-link port is PPPoE Client, assign the local interface as PPP Server. If up-link port is DHCP Client, assign the local interface as DHCP Server. Also, if up-link interface is assigned with Static IP, configure the local interface as static.

Up-link Interface (LAN 0)	Local Interface (LAN 1)	Configurability
DHCP	DHCP	○
	PPP	○
	Static	X
PPP	DHCP	○
	PPP	○
	Static	X
Static	DHCP	X
	PPP	X

---

---

Static	○
--------	---

---

## Related APOS commands & structure

The below parameters should be configured at the VoIP Gateway for the above application.

- IP address configuration of LAN 0 & LAN 1 interface: PPPoE, DHCP, Static
- IP address of default router: Optional
- Traffic QoS configuration for LAN 0 interface: Optional
- IP sharing configuration

## DHCP environment with public IP address assigned

DHCP environment application is for the users of broadband network using cable modems.

### APOS command script

```
!
dhcp-list 0 type server
dhcp-list 0 address server interface ether0.0
dhcp-list 0 option dhcp-lease-time 600
!
ip-share enable
ip-share interface net-side ether0.0
ip-share interface local-side ether1.0
!
interface ether0.0
  ip address dhcp
  mac-address 00:02:a5:00:00:00
  qos 200 150
!
interface ether1.0
  no ip address
  ip dhcp-group 0
!
```

Step	Commands	Description
1	# # <b>config</b> Enter configuration commands, one per line. End with CNTL/Z (config)#	Enter APOS global configuration mode.
2	(config)# <b>dhcp-list 0 type server</b>	configure the VoIP gateway as DHCP server.
3	(config)# <b>dhcp-list 0 address server interface ether0.0</b>	Assign the IP address of the interface as the IP address of DHCP server.
4	(config)# <b>dhcp-list 0 option dhcp-lease-time 600</b>	The public IP address from Cable network is refreshed periodically. The internal PCs check for the IP address at every 300 seconds (600/2). It is recommend to configure "dhcp-lease-time" as "10 min".
5	(config)# <b>ip-share enable</b>	Enable IP sharing
6	(config)# <b>ip-share interface net-side ether0.0</b>	Assign the public IP address to the Ethernet interface 0.0.
7	(config)# <b>ip-share interface local-side ether1.0</b>	Connect Internal PCs or other devices



		to the Ethernet Interface 1.0.
<b>8</b>	<code>(config)# interface ether0.0</code>	Enter the interface configuration mode.
<b>9</b>	<code>(config-ether0.0)# ip address dhcp</code>	Assign the IP address with DHCP.
<b>10</b>	<code>(config-ether0.0)# mac-address 00:02:a5:00:00:00</code>	Change the MAC address of the Ethernet 0 as "00:02:a5:00:00:00." Some cable modems ask for the MAC address of the internal PC for the authentication. Use the MAC address of the internal PC for the Ethernet interface 0.0. (The MAC address of the VoIP gateway is changed temporary and the original address is recovered when the command is removed.) Use this command only when it is necessary.
<b>11</b>	<code>(config-ether0.0)# qos 200 150</code>	Configure QoS.
<b>12</b>	<code>(config-ether0.0)# interface ether1.0</code>	Enter the interface configuration mode.
<b>13</b>	<code>(config-ether1.0)# no ip address</code>	Do not assign an IP address to the interface.
<b>14</b>	<code>(config-ether1.0)# ip dhcp-grou 0</code>	To share a dynamically allocated IP address, configure the interface as DHCP Server interface.
<b>15</b>	<code>(config-ether1.0)# exit</code> <code>(config)#</code>	Exit from the interface configuration mode.
<b>16</b>	<code>(config)# exit</code> <code>#</code>	Exit from APOS global configuration mode.

## PPPoE environment with public IP assigned

PPPoE environment application is for the users of broadband network using ADSL modems.

### APOS command script

```
!
ip-share enable
ip-share interface net-side ether0.0
ip-share interface local-side ether1.0
!
interface ether0.0
no ip address
encapsulation pppoe
ppp authentication pap callin
ppp pap sent-username addpac password test
ppp echo interval 20
ppp ipcp ms-dns
ppp ipcp default-route
qos 200 150
!
interface ether1.0
no ip address
encapsulation pppoe
ppp authentication pap callin
ppp pap sent-username addpac password test
ppp echo interval 20
ppp ipcp ms-dns
ppp ipcp default-route
ppp role server
!
```

Step	Commands	Description
1	# # <b>config</b> Enter configuration commands, one per line. End with CNTL/Z (config)#	Enter APOS global configuration mode.
2	(config)# <b>ip-share enable</b>	Enable IP sharing.
3	(config)# <b>ip-share interface net-side ether0.0</b>	Configure IP sharing features on the Ethernet interface 0.0, the interface for external access.
4	(config)# <b>ip-share interface local-side ether1.0</b>	Configure IP sharing features on the Ethernet interface 1.0, the interface for internal access.
5	(config)# <b>interface ether0.0</b> (config-ether0.0)#	Enter the interface configuration mode.
6	(config-ether0.0)# <b>no ip address</b>	Do not assign an IP address to the

		interface.
7	(config-ether0.0)# <b>encapsulation pppoe</b>	Configure encapsulation type.
8	(config-ether0.0)# <b>ppp authentication pap callin</b>	Configure PPP authentication as PAP.
9	(config-ether0.0)# <b>ppp pap sent-username addpac password test</b>	Configure the PAP User ID as "addpac" and the password as "1234".
10	(config-ether0.0)# <b>ppp echo interval 20</b>	
11	(config-ether0.0)# <b>ppp ipcp ms-dns</b>	Configure to get default router IP from PPP Server.
12	(config-ether0.0)# <b>ppp ipcp default-route</b>	Configure to get DNS IP from PPP Server.
13	(config-ether0.0)# <b>qos 200 150</b>	
14	(config-ether0.0)# <b>interface ether1.0</b> (config-ether1.0)#	Enter the interface configuration mode.
15	(config-ether1.0)# <b>no ip address</b>	Do not assign an IP address to the interface.
16	(config-ether1.0)# <b>encapsulation pppoe</b>	Configure encapsulation type.
17	(config-ether1.0)# <b>ppp authentication pap callin</b>	Configure PPP authentication as PAP.
18	(config-ether0.0)# <b>ppp pap sent-username addpac password test</b>	Configure the PAP User ID as "addpac" and the password as "1234".
19	(config-ether1.0)# <b>ppp echo interval 20</b>	
20	(config-ether1.0)# <b>ppp ipcp ms-dns</b>	Configure to get default router IP from PPP Server.
21	(config-ether1.0)# <b>ppp ipcp default-route</b>	Configure to get DNS IP from PPP Server.
22	(config-ether1.0)# <b>ppp role server</b> Set to PPPoE Server	
23	(config-ether1.0)# <b>exit</b> (config)#	Exit the interface configuration mode.
24	(config)# <b>exit</b> #	Exit from APOS global configuration mode.

## Fixed IP environment with public IP assigned

Fixed IP environment with a public IP address is for the users of broadband network using a WAN router (PPP, HDLC, Frame-Relay, ATM and etc.).

### Configurations (static)

```
!
ip-share enable
ip-share interface net-side ether0.0
ip-share interface local-side ether1.0
!
interface ether0.0
 ip address 192.168.1.2 255.255.255.0
!
interface ether1.0
 no ip address
!
route 0.0.0.0 0.0.0.0 192.168.1.1
!
```

Step	Commands	Description
1	# # <b>config</b> Enter configuration commands, one per line. End with CNTL/Z (config)#	Enter APOS global configuration mode.
2	(config)# <b>ip-share enable</b>	Enable IP sharing feature.
3	(config)# <b>ip-share interface net-side ether0.0</b>	Configure IP sharing features on the Ethernet interface 0.0, the interface for external access.
4	(config)# <b>ip-share interface local-side ether1.0</b>	Configure IP sharing features on the Ethernet interface 1.0, the interface for internal access.
5	(config)# <b>interface ether0.0</b> (config-ether0.0)#	Enter the interface configuration mode.
6	(config-ether0.0)# <b>ip address 192.168.1.2 255.255.255.0</b>	Assign the IP address to the interface.
7	(config-ether0.0)# <b>interface ether1.0</b> (config-ether1.0)#	Enter the interface configuration mode.
8	(config-ether1.0)# <b>no ip address</b>	
9	(config-ether1.0)# <b>route 0.0.0.0 0.0.0.0 192.168.1.1</b>	Assign the default router.
10	(config-ether1.0)# <b>exit</b>	Exits from the interface configuration

---

	(config)#	mode.
<b>11</b>	(config)# <b>exit</b>	Exits from APOS global configuration
	#	mode.

---

# PAT Server (VoIP Gateway) Application

In this application, the VoIP gateway operates as a PAT server. The VoIP gateway connected to the external network is assigned with a public IP address and shares it with the equipment on the internal network. This application is available for both dynamic IP address environment via ADSL Modem or Cable Modem and fixed IP address environment via ADSL modem or leased line.

**NOTE** PAT Server Application is supported by AddPac Technology's all VoIP products along with VoIP Gateway

## Network Diagram

A VoIP gateway is assigned with a public & dynamic IP through PPPoE or DHCP. Then it shares the public IP address with the equipment of the internal network by using port mapping method.

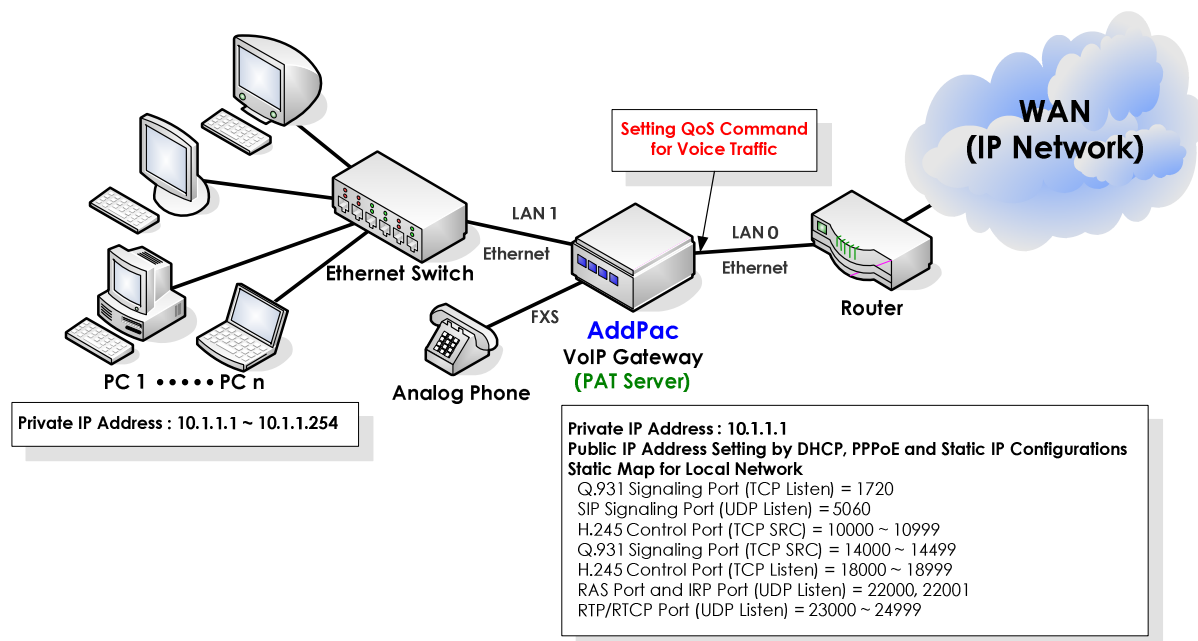

**Fig. 3-8 VoIP network diagram of VoIP gateway operating as PAT server**

This is the typical application of VoIP gateway operating as PAT server. In this case, VoIP network configuration and PAT static map for address translation are also required.

The VoIP gateway offers both VoIP gateway function and PAT server function. Thus the static TCP/UDP map configuration explained at

the previous chapter should be done on the gateway.

At the view of packet transmission path, this application is same as that of Bridge mode. So QoS configuration of Ethernet 0.0 Interface (LAN 0) of the VoIP Gateway is possible to allow higher priority for the voice traffic. With this QoS configuration, the VoIP Gateway can offer priority and bandwidth control for all the data coming through Ethernet 1.0 (LAN 1) and VoIP traffic as well, which realizes optimized voice quality.

If the customer network is not allowed to change, the "IP sharing" application is recommended.

#### APOS command script

```
!  
nat-list 1 pat static-entry tcp 1720 local  
nat-list 1 pat static-entry udp 5060 local  
nat-list 1 pat group-static-entry udp 22000 22001 local  
nat-list 1 pat group-static-entry udp 23000 24999 local  
nat-list 1 pat group-static-entry tcp 10000 10999 local  
nat-list 1 pat group-static-entry tcp 14000 14999 local  
nat-list 1 pat group-static-entry tcp 18000 18999 local  
  
nat-list 1 pat static-entry tcp 23 local  
nat-list 1 pat group-static-entry tcp 20 21 local  
nat-list 1 pat group-static-entry udp 67 68 local  
nat-list 1 pat static-entry icmp ping local  
interface ether0.0  
  ip address dhcp  
!  
interface ether1.0  
ip address 10.1.1.1 255.255.255.0  
ip nat-group 1 pat ether0.0  
ip dhcp-group 0  
!
```

## Related APOS commands & structure

Configure the below parameters appropriate for the network environment.

- IP configuration for LAN0 : (DHCP or PPPoE or static)
- IP address of default router: Optional
- QoS configuration of LAN 0 Ethernet interface
- NAT static map

- NAT configuration binding in local interface (e1.0)
- VoIP configuration

Step	Commands	Description
1	# # <b>config</b> Enter configuration commands, one per line. End with CNTL/Z (config)#	Enter APOS global configuration mode.
2	(config)# (config)# <b>nat-list 1 pat static-entry tcp 1720 local</b>	H.323/Q.931 signaling listen port (TCP1720) for incoming calls.
3	(config)# <b>nat-list 1 pat static-entry udp 5060 local</b>	listen Port(UDP 5060). SIP signaling listen port (UDP5060) for incoming calls.
4	(config)# <b>nat-list 1 pat group-static-entry udp 22000 22001 local</b>	RAS and IRR listening port for GK
5	(config)# <b>nat-list 1 pat group-static-entry udp 23000 24999 local</b>	RTP/RTCP source port for voice communication
6	(config)# <b>nat-list 1 pat group-static-entry tcp 10000 10999 local</b>	TCP source port for H.245 control
7	(config)# <b>nat-list 1 pat group-static-entry tcp 14000 14999 local</b>	Q931 Signaling Source Port
8	(config)# <b>nat-list 1 pat group-static-entry tcp 18000 18999 local</b>	TCP listen port for H245 control
9	(config)# <b>nat-list 1 pat static-entry tcp 23 local</b>	TCP listen Port (Telnet)
10	(config)# <b>nat-list 1 pat group-static-entry tcp 20 21 local</b>	TCP listen Port (FTP)
11	(config)# <b>nat-list 1 pat group-static-entry udp 67 68 local</b>	TCP listen Port (BOOTP- for DHCP client). When the public IP is assigned by DHCP
12	(config)# <b>nat-list 1 pat static-entry icmp ping local</b>	TCP listen Port (ICMP - for Ping)
13	(config)# <b>interface ether0.0</b>	
14	(config-ether0.0)# <b>ip address dhcp</b>	
15	(config-ether0.0)# <b>interface ether1.0</b>	Enter the interface configuration mode.
16	(config-ether1.0)# <b>ip address 10.1.1.1 255.255.255.0</b>	Assign the IP address to the interface.



---

<b>17</b>	<code>(config-ether1.0)# ip nat-group 1 pat ether0.0 ip dhcp-group 0</code>	Share the public IP of LAN 0.0 with the local devices of LAN 1.0.
	<code>Invalid input command - (0)</code>	
<b>18</b>	<code>(config-ether1.0)# exit (config)#</code>	Exits from the interface configuration mode.
<b>19</b>	<code>(config)# exit #</code>	Exits from APOS global configuration mode.

---

# Chapter 4. VoIP Network Configuration

This chapter provides information for configuring Call Routing, E.164 and Gatekeeper related parameters along with additional features. For more detailed information on APOS commands which are not mentioned on this guide refer to APOS Operation Guide.

## Point-to-Point Application

This application is recommended for the companies with only small number of remote offices. Each VoIP Gateway should have the routing information such as dial-peer which is the called party telephone number to be connected.

**NOTE** Point-to-Point Application is supported by AddPac Technology's all VoIP products along with VoIP Gateway.

### Network Diagram

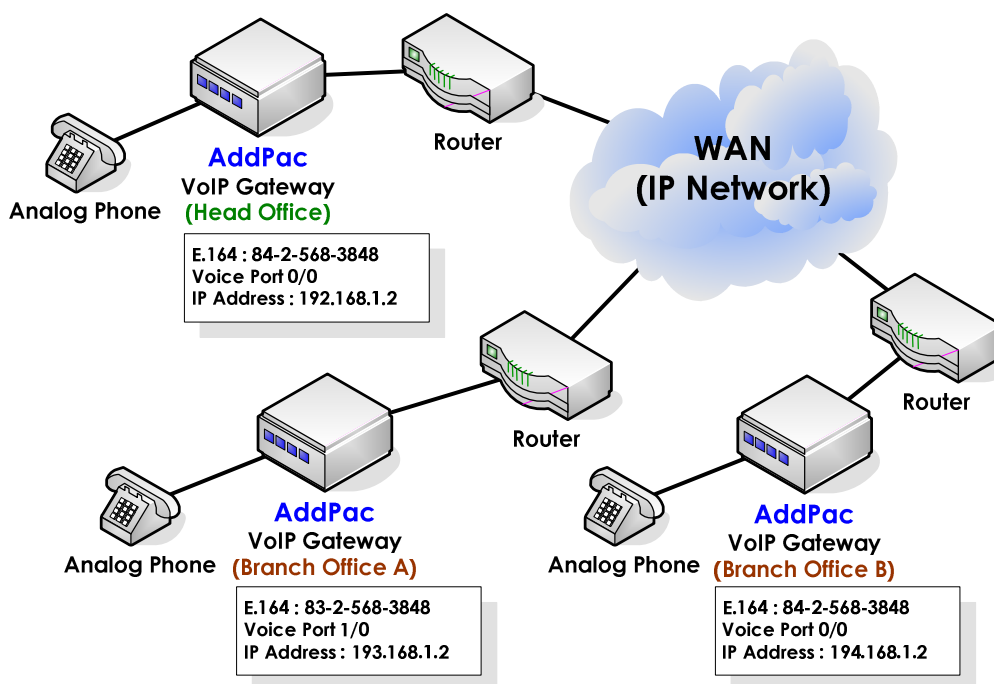

Fig. 4-1 VoIP network diagram of peer-to-peer communication

---

**APOS command script (Head Office)**

---

```
!  
hostname HO  
!  
interface ether0.0  
  ip address 192.168.1.1 255.255.255.0  
!  
!  
dial-peer voice 0 pots  
  destination-pattern 8225683848  
  port 0/0  
!  
dial-peer voice 1000 voip  
  destination-pattern 8325683848  
  session target 193.158.1.2  
  dtmf-relay h245-alphanumeric  
!  
dial-peer voice 1001 voip  
  destination-pattern 84T  
  session target 194.158.1.2  
  dtmf-relay h245-alphanumeric  
!  
voip-interface ether0.0  
!
```

---

---

**APOS command script (Branch A)**

---

```
!  
hostname BA  
!  
interface ether0.0  
  ip address 192.168.1.1 255.255.255.0  
!  
!  
dial-peer voice 0 pots  
  destination-pattern 8325683848  
  port 1/0  
!  
dial-peer voice 1000 voip  
  destination-pattern 82.....  
  session target 192.158.1.2  
  dtmf-relay h245-alphanumeric  
!  
dial-peer voice 1001 voip  
  destination-pattern 8425683848  
  session target 194.158.1.2  
  dtmf-relay h245-alphanumeric  
!  
voip-interface ether0.0  
!
```

---

---

**APOS command script (Branch B)**

---

```
!  
hostname BB
```

---

```

!
interface ether0.0
 ip address 194.168.1.1 255.255.255.0
!
!
dial-peer voice 0 pots
destination-pattern 8425683848
port 0/0
!
dial-peer voice 1000 voip
 destination-pattern 8225683848
 session target 192.158.1.2
 dtmf-relay h245-alphanumeric
!
dial-peer voice 1001 voip
 destination-pattern 8325683848
 session target 193.158.1.2
 dtmf-relay h245-alphanumeric
!
voip-interface ether0.0
!

```

## Related APOS commands & structure

Configure the below parameters appropriate for the network environment.

- IP address of VoIP gateway
- Default router
- Dial-peer VoIP
- Dial-peer POTS
- VoIP interface

To configure point-to-point application, follow this procedure.

Step	Commands	Description
1	HO(config-ether0.0)# <b>dial-peer voice 0 pots</b> HO(config-dialpeer-pots-0)#	Create a pots peer to group destination pattern and a specific physical voice interface. The tag number "0" is assigned for the pots peer. (The valid tag number range is "0 ~ 65,535" and typically it starts from "0".)
2	HO(config-dialpeer-pots-0)# <b>destination-pattern 8225683848</b>	Define the full E.164 phone number to be used for the dial

		peer.
<b>3</b>	HO(config-dialpeer-pots-0)# <b>port 0/0</b>	Associate a POTS dial peer with a specific voice port. (The no. of voice ports and their kinds are different by each device.)
<b>4</b>	HO(config-dialpeer-pots-0)# <b>dial-peer voice 1000 voip</b> HO(config-dialpeer-voip-1000)#	Create a VoIP dial peer for VoIP call setup. The tag number "1000" is assigned for the VoIP peer. (The valid tag number range is "0 ~ 65,535" and typically it starts from "1000".)
<b>5</b>	HO(config-dialpeer-voip-1000)# <b>destination-pattern 8325683848</b>	Assign the called party number for the VoIP peer.
<b>6</b>	HO(config-dialpeer-voip-1000)# <b>session target 193.158.1.2</b>	Send the VoIP call connection messages to the gatekeeper.
<b>7</b>	HO(config-dialpeer-voip-1000)# <b>dtmf-relay h245-alphanumeric</b>	Define the DTMF transmission type as "H. 245 Alphanumeric".
<b>8</b>	HO(config-dialpeer-voip-1000)# <b>dial-peer voice 1001 voip</b>	Create a VoIP dial-peer for VoIP call setup.
<b>9</b>	HO(config-dialpeer-voip-1001)# <b>destination-pattern 84T</b>	Assign the called party number stating with "84" for the VoIP dial-peer.
<b>10</b>	HO(config-dialpeer-voip-1001)# <b>session target 194.158.1.2</b>	Send the VoIP call connection message to the gatekeeper.
<b>11</b>	HO(config-dialpeer-voip-1001)# <b>dtmf-relay h245-alphanumeric</b>	Define the DTMF transmission type as "H. 245 Alphanumeric".
<b>12</b>	HO(config-dialpeer-voip-1001)# <b>voip-interface ether0.0</b> VOIP_INTERFACE_DOWN : (192.168.1.1) VOIP_INTERFACE_UP : (192.168.1.1) Gatekeeper shutdowned. HO(config)#	Assign VoIP interface.
<b>13</b>	HO(config)# <b>exit</b> HO#	Exit from APOS global configuration mode.

## Gatekeeper Interoperating Application

The VoIP network environment with Gatekeeper is recommended for the middle and large scale enterprises or individual users using Internet telephony services provided by ITSPs (Internet Telephony Service Provider). Each VoIP Gateway registers its ID (a telephone number) and establishes VoIP calls. Thus, the VoIP Gateway configuration is much simpler.

**NOTE** Gatekeeper Interoperating Application is supported by AddPac Technology's all VoIP products along with VoIP Gateway.

### Network Diagram

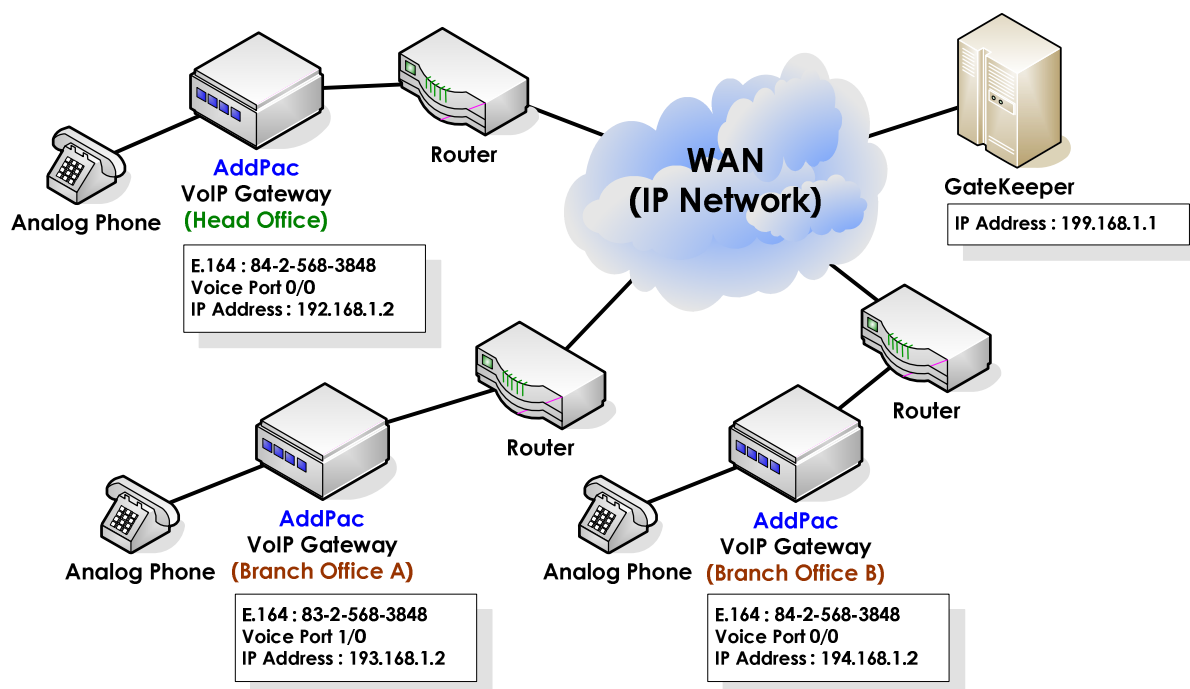

Fig. 4-2 VoIP network diagram of Gatekeeper interoperating application

#### APOS command script (Head office)

```
!
hostname HO
!
interface ether0.0
 ip address 192.168.1.1 255.255.255.0
!
!
dial-peer voice 0 pots
 destination-pattern 8225683848
 port 0/0
```

---

```
!  
dial-peer voice 1000 voip  
  destination-pattern 8325683848  
  session target ras  
dtmf-relay h245-alphanumeric  
!  
dial-peer voice 1001 voip  
  destination-pattern 84T  
  session target ras  
dtmf-relay h245-alphanumeric  
!  
gateway  
  h323-id addpac  
gkip 199.168.1.1 1719 128  
register  
!  
voip-interface ether0.0  
!
```

---

#### APOS command script (Branch A)

```
!  
hostname BA  
!  
interface ether0.0  
  ip address 193.168.1.1 255.255.255.0  
!  
!  
dial-peer voice 0 pots  
  destination-pattern 8325683848  
  port 1/0  
!  
dial-peer voice 1000 voip  
  destination-pattern T  
  session target ras  
dtmf-relay h245-alphanumeric  
!  
gateway  
  h323-id addpac  
gkip 199.168.1.1 1719 128  
register  
!  
voip-interface ether0.0  
!
```

---

#### APOS command script (Branch B)

```
!  
hostname BB  
!  
interface ether0.0  
  ip address 194.168.1.1 255.255.255.0  
!  
!  
dial-peer voice 0 pots  
  destination-pattern 8425683848  
  port 0/0
```

---

```
!  
dial-peer voice 1000 voip  
  destination-pattern 8T  
  session target 192.158.1.2  
  dtmf-relay h245-alphanumeric  
!  
voip-interface ether0.0  
!
```

---

### APOS command script (Configuration Verification)

---

```
HO# show gateway
```

#### Gatekeeper Registration Information

```
H.323 id = addpac  
gatekeeper registration option = enabled  
gatekeeper security option = disabled  
Gatekeeper registration status :  
  registered.  
  last registration reject information from gatekeeper  
    ConfigAsNoRegistration (Aug 9 03:02:43)
```

#### Gatekeeper list :

```
  199.168.1.1          1719  priority(128)  by user
```

#### Local aliases

```
  [1] H323ID : addpac  
  [2] 8225683848
```

#### Technical prefixes

#### Gateway Information

```
status = init 1 (waiting for setting IP address on a VoIP interface)  
product name = AddPac VoIP  
product version = 6.12  
endpoint type = gateway
```

```
discovery (send GRQ) = disabled  
ARQ option = arq default  
LRQ option = no lrq  
lightweight IRR = disabled  
TTL margin = 20 %
```

```
h323 call start mode = fast  
h323 call tunneling mode = enabled  
h323 call channel mode = late  
h323 response msg = default  
system fax mode = t38  
system fax rate (bps) = 9600  
system T.38 fax redundancy = 0  
force to send startH245 = enabled  
dialPeer hunt algorithm = longest - preference - random  
translate voip incoming called number = -1  
translate voip incoming calling number = -1  
local ringback tone = normal  
end of digit = #  
ip address prefix = *
```



---

```
voice confirmed connect on FXO/E&M = disabled
```

```
number of ports = 1
number of pots peers = 1
number of voip peers = 2
number of number expansions = 0
number of codec classes = 0
number of alternate gatekeepers = 1
number of current calls = 0
```

#### Announcement Option

```
language = korean
element : delayed dial = disabled
element : wrong number = disabled
element : connection fail = disabled
```

#### Timer & Counter parameter value

```
tinit (initial digit timer) = 10 sec.
tring (ring timer) = 30 sec.
t301 (alert -> connect) = 180 sec.
t303 (setup -> alert) = 20 sec.
tras (RAS msg ack timer) = 6 sec.
tttl (RAS Time To Live timer) = 60 sec.
tidt (inter digit timer) = 3 sec.
treg (GK Registration retry timer) = 20 sec.
treg2 (GK Registration retry timer : long period by RRJ) = 120 sec.
tohd (On Hook Delay Time) = 0 sec.
tpoll (polling timer on trunk or polling type connection) = 180 sec.
dtmf duration = 150 msec.
dtmf guard time = 100 msec.
cras (RAS retry counter) = 3
```

#### Remote Call Log (syslog)

```
primary server =
secondary server =
interval = 0 minutes
cdr format type = 0
```

#### Assigned VoIP TCP/UDP ports

```
minimized assign = no
Q.931 signalling port (TCP listen) = 1720
SIP signalling port (UDP listen) = 5060
H.245 control port (TCP src) = 10000 - 10999
Q.931 signalling port (TCP src) = 14000 - 14499
H.245 control port (TCP listen) = 18000 - 18999
RAS port and IRR port (UDP listen) = 22000, 22001
RTP/RTCP port (UDP listen) = 23000 - 24999
```

---

## Related APOS commands & structure

Configure the below parameters appropriate for the network environment.

- IP address of VoIP gateway
- Default router
- E.164 number for VoIP gateway registration
- H.323 ID
- IP address of VoIP Gatekeeper

To configure Gatekeeper Interoperating Application, follow this procedure.

Step	Commands	Description
1	HO(config-ether0.0)# <b>dial-peer voice 0 pots</b>	Create a pots peer to group destination pattern and a specific physical voice interface. The tag number "0" is assigned for the pots peer. (The valid tag number range is "0 ~ 65,535" and typically it starts from "0".)
2	HO(config-dialpeer-pots-0)# <b>destination-pattern 8225683848</b>	Define the full E.164 phone number to be used for the dial peer.
3	HO(config-dialpeer-pots-0)# <b>port 0/0</b>	Associate a POTS dial peer with a specific voice port. (The no. of voice ports and their kinds are different by each device.)
4	HO(config-dialpeer-pots-0)# <b>dial-peer voice 1000 voip</b>	Create a VoIP dial peer for VoIP call setup. The tag number "1000" is assigned for the VoIP peer. (The valid tag number range is "0 ~ 65,535" and typically it starts from "1000".)
5	HO(config-dialpeer-voip-1000)# <b>destination-pattern 8325683848</b>	Assign the called party number for the VoIP peer.
6	HO(config-dialpeer-voip-1000)# <b>session target ras</b>	Send the VoIP call connection message to the gatekeeper.
7	HO(config-dialpeer-voip-1000)# <b>dtmf-relay h245-alphanumeric</b>	Define the DTMF transmission type as "H. 245 Alphanumeric".
8	HO(config-dialpeer-voip-1000)# <b>dial-peer voice 1001 voip</b>	Create a VoIP dial-peer for VoIP call setup.

<b>9</b>	HO(config-dialpeer-voip-1001)# <b>destination-pattern 84T</b>	Assign the called party number stating with "84" for the VoIP dial-peer.
<b>10</b>	HO(config-dialpeer-voip-1001)# <b>session target ras</b>	Send the VoIP call connection message to the gatekeeper.
<b>11</b>	HO(config-dialpeer-voip-1001)# <b>dtmf-relay h245-alphanumeric</b>	Define the DTMF transmission type as "H. 245 Alphanumeric".
<b>12</b>	HO(config-dialpeer-voip-1001)# <b>gateway</b>	Enter the gatekeeper configuration mode.
<b>13</b>	HO(config-gateway)# <b>h323-id addpac</b>	Assign H.323 ID.
<b>14</b>	HO(config-gateway)# <b>gkip 199.168.1.1 1719 128</b>	Assign the IP address of the gatekeeper.
<b>15</b>	HO(config-gateway)# <b>register</b>	Register to the gatekeeper.
<b>16</b>	HO(config-gateway)# <b>voip-interface ether0.0</b> VOIP_INTERFACE_DOWN : (192.168.1.1) VOIP_INTERFACE_UP : (192.168.1.1) Gatekeeper shutdowned. HO(config)#	Assign VoIP interface.
<b>17</b>	HO(config)# <b>exit</b> HO#	Exit from APOS global configuration mode.

# Number Translation Feature

This part provides information about prefixing or digit stripping number translation of called party and calling party telephone numbers at the VoIP gateway.

**NOTE** Number Translation is supported by AddPac Technology's all VoIP products along with VoIP Gateway.

## Network Diagram

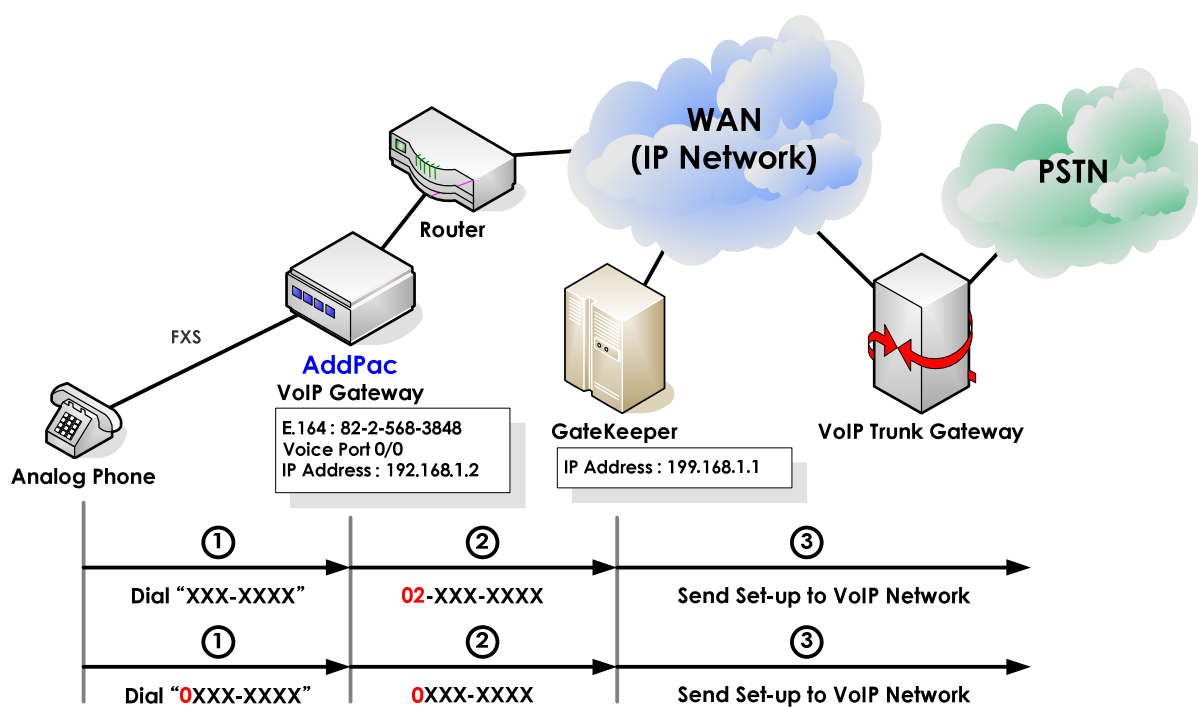

Fig. 4-3 VoIP gateway number translation feature diagram

### APOS command script

```
! Pots peer configuration.
!
dial-peer voice 0 pots
 destination-pattern 8225683848
 port 0/0
!
! Voip peer configuration.
!
dial-peer voice 1000 voip
 destination-pattern T
 session target ras
```

---

```

dtmf-relay h245-alphanumeric
  translate-outgoing called-number 0
!
! Gateway configuration.
!
gateway
  h323-id addpac
  gkip 199.168.1.1 1719 128
  register
!
!
! Translation Rule configuration.
!
translation-rule 0
rule 0      [1-9]T          02%99
!

```

---

## Number Translation Example

```

rule 0 1234T  %01%03%99
  Translated numbers
  1234      → 134
  12345678 → 1345678
  1235678  → 1235678 (the rule is not applied.)
rule 0 T  %04%03%98
  Translated numbers
  1235      → 53
  1235678  → 53
  1245678  → 54
rule 0 T  999%03%04%99
  Translated numbers
  1236      → 99936
  12345678 → 999345678
  1235678  → 99935678
rule 0 [1-3]T  000%99
  Translated numbers
  1234      → 0001234
  2345678  → 0002345678
  4567890  → 4567890 (the rule is not applied.)
rule 0 [1-3]T  %01%02%03%98
  Translated numbers
  1234      → 123
  2345678  → 234
  4567890  → 4567890 (the rule is not applied.)

```

### APOS command script (Configuration Verification)

```

HO(config)# show translation-rule

translation-rule 0
rule 0 [1-9]T 02%99

HO(config)# show translation-rule 0 1234

The translation result is (021234)

HO(config)# show translation-rule 0 021234

The translation result is (021234)!

```

## Related APOS commands & structure

At the above diagram, VoIP gateway prefixes “02” for all the called party number. However, if the called party number starts with “0”, there is no prefixing.

Please note the configuration of translation rules and how the rule is applied to the VoIP peer.

Configure the below parameters appropriate for the network environment.

- E.164 number for registration of VoIP Gateway or VoIP router
- H.323 ID (at gatekeeper interoperating mode)
- IP address of the gatekeeper (at gatekeeper interoperating mode)
- ID number of the gatekeeper (at gatekeeper interoperating mode)
- Number translation rules

To configure the feature, follow this procedure.

Step	Commands	Description
1	BB(config-dialpeer-voip-1000)# <b>translate-outgoing called-number 0</b>	Apply the Translation rule 0 to the called party number of the

---

		dial-peer 1000.
<b>2</b>	BB(config-gateway)# <b>translation-rule 0</b>	
<b>3</b>	BB(config-translation-rule#0)# <b>rule 0 [1-9]T 02%99</b>	Prefix "02" if the number starts with the digit among "1-9" Ex.) 12345678 -> 0212345678 "%99" refers to the rest digits except the first digit.

---

# Call Pickup & Transfer Feature

The call pick-up feature allows the user to answer a call that comes in on a number other than his/her own. Also the users can transfer an established call to other numbers with the call transfer feature.

**NOTE** Call Pickup & Transfer is supported by AddPac Technology's all VoIP products along with VoIP Gateway.

## Network Diagram

The below is the network diagram of Call-pickup feature.

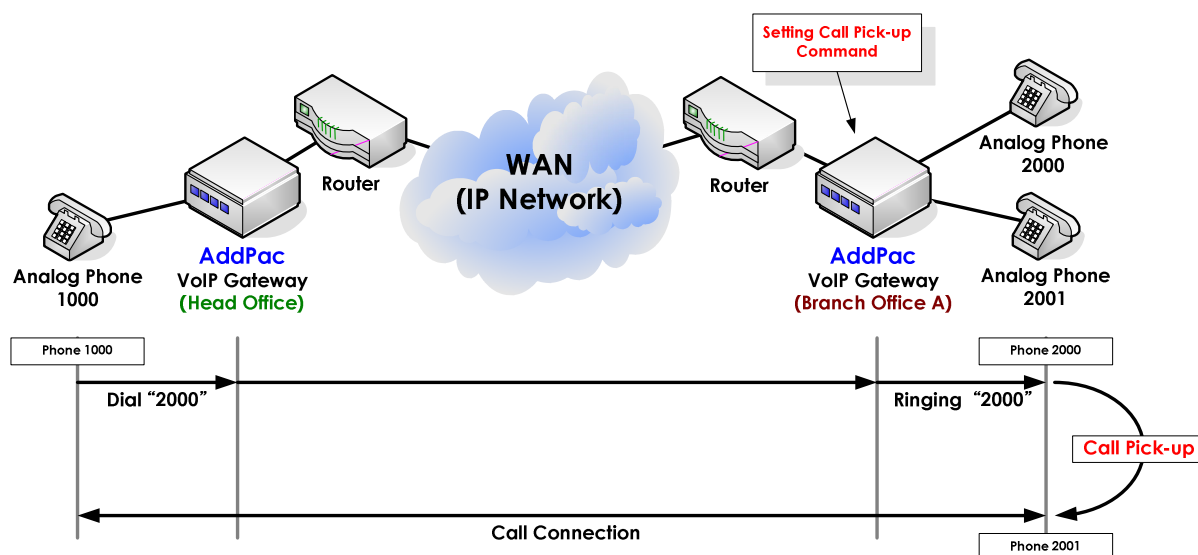

**Fig. 4-4 VoIP gateway Call-pickup feature**

According to the above examples, the user of the telephone 1000 at the head office tries a call to the telephone 2000 at the branch office A. When the user of telephone 2000 is absent, the telephone 2001 picks up the call by pressing special keys “##”.

**NOTE** The special key ( “##” ) used here is an example, and the VoIP Gateway operators are allowed to choose any keys.



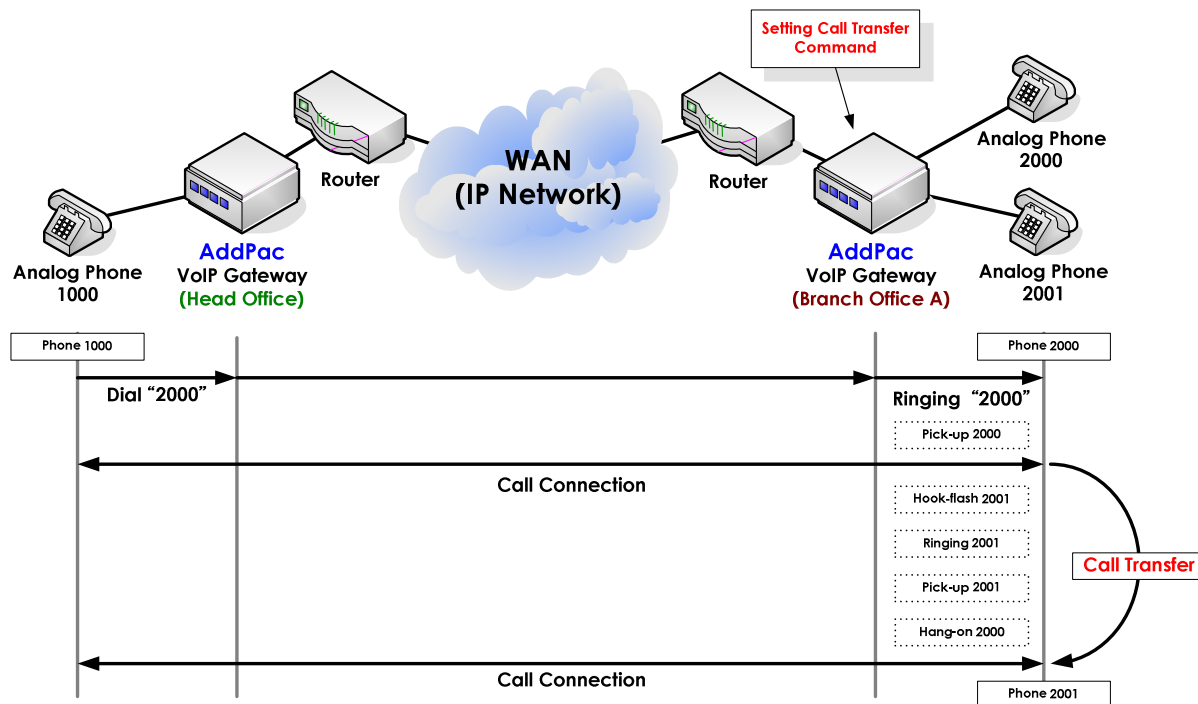

Fig. 4-5 VoIP gateway Call-transfer feature

In the above example, the user of the telephone 1000 at the head office calls to the telephone 2000 at the branch office. The called party picks up the phone and finishes the conversation. When the called party tries to transfer the call to the user of telephone 2001, the called party presses the special key for call transfer ("Hook-flash") and "2001". Then the telephone 2001 rings and with the hook-off of the telephone 2001, the user of telephone 2000 hangs up. Then the call between the telephone 1000 and the telephone 2001 is established.

**NOTE** The special keys can be not changed by the VoIP Gateway operator.

```

APOS command script (Call pick-up & transfer configuration)
!
hostname BB
!
interface ether0.0
  ip address 194.168.1.1 255.255.255.0
!
!
dial-peer voice 0 pots
  destination-pattern 2000
  port 0/0
!
    
```

```
dial-peer voice 1 pots
 destination-pattern 2001
 port 0/1
!
dial-peer voice 1000 voip
 destination-pattern 1...
 session target 192.158.1.2
 dtmf-relay h245-alphanumeric
!
dial-peer call-pickup ##
dial-peer call-transfer h
!
voip-interface ether0.0
!
```

### APOS command script (Call pick-up & transfer configuration Verification)

```
Branch-A# show gateway
```

#### Gatekeeper Registration Information

```
H.323 id = addpac
gatekeeper registration option = enabled
gatekeeper security option = disabled
Gatekeeper registration status :
    not registered.
    last registration reject information from gatekeeper
        ConfigAsNoRegistration (Aug 9 03:02:43)
```

```
Gatekeeper list :
```

#### Local aliases

```
[1] H323ID : addpac
[2] 2000
[3] 2001
```

#### Technical prefixes

#### Gateway Information

```
status = init 1 (waiting for setting IP address on a VoIP interface)
product name = AddPac VoIP
product version = 6.12
endpoint type = gateway
```

```
discovery (send GRQ) = disabled
ARQ option = arq default
LRQ option = no lrq
lightweight IRR = disabled
TTL margin = 20 %
```

```
h323 call start mode = fast
h323 call tunneling mode = enabled
h323 call channel mode = late
h323 response msg = default
system fax mode = t38
system fax rate (bps) = 9600
system T.38 fax redundancy = 0
force to send startH245 = enabled
```

---

```
dialPeer hunt algorithm = longest - preference - random
translate voip incoming called number = -1
translate voip incoming calling number = -1
local ringback tone = normal
end of digit = #
ip address prefix = *
voice confirmed connect on FXO/E&M = disabled
call pickup digits = ##
call transfer = enabled (hookflash)
```

```
number of ports = 1
number of pots peers = 3
number of voip peers = 2
number of number expansions = 0
number of codec classes = 0
number of alternate gatekeepers = 1
number of current calls = 0
```

#### Announcement Option

```
language = korean
element : delayed dial = disabled
element : wrong number = disabled
element : connection fail = disabled
```

#### Timer & Counter parameter value

```
tinit (initial digit timer) = 10 sec.
tring (ring timer) = 30 sec.
t301 (alert -> connect) = 180 sec.
t303 (setup -> alert) = 20 sec.
tras (RAS msg ack timer) = 6 sec.
tttl (RAS Time To Live timer) = 60 sec.
tidt (inter digit timer) = 3 sec.
treg (GK Registration retry timer) = 20 sec.
treg2 (GK Registration retry timer : long period by RRJ) = 120 sec.
tohd (On Hook Delay Time) = 0 sec.
tpoll (polling timer on trunk or polling type connection) = 180 sec.
dtmf duration = 150 msec.
dtmf guard time = 100 msec.
cras (RAS retry counter) = 3
```

#### Remote Call Log (syslog)

```
primary server =
secondary server =
interval = 0 minutes
cdr format type = 0
```

#### Assigned VoIP TCP/UDP ports

```
minimized assign = no
Q.931 signalling port (TCP listen) = 1720
SIP signalling port (UDP listen) = 5060
H.245 control port (TCP src) = 10000 - 10999
Q.931 signalling port (TCP src) = 14000 - 14499
H.245 control port (TCP listen) = 18000 - 18999
RAS port and IRR port (UDP listen) = 22000, 22001
RTP/RTCP port (UDP listen) = 23000 - 24999
```

---

## Related APOS commands & structure

- E.164 number for registration of VoIP Gateway or VoIP router
- H.323 ID (at gatekeeper interoperating mode)
- IP address of the gatekeeper (at gatekeeper interoperating mode)
- ID number of the gatekeeper (at gatekeeper interoperating mode)
- call Transfer configuration
- call pick-up configuration

To configure the feature, follow this procedure.

Step	Commands	Description
1	BB(config-dialpeer-voip-1000)# <b>dial-peer call-pickup ##</b>	Enable the Call pick-up features. ("##" is a special key randomly assigned for the feature.)
2	BB(config)# <b>dial-peer call-transfer h</b>	Enable Call transfer feature. ("h" means "hook-flash")

---

---

# Chapter 5. VoIP Protocol Configuration

---

---

This chapter provides information on configuring VoIP signaling protocols. AddPac Technology's VoIP Gateway supports H.323, SIP and MGCP protocols. H.323 is mainly explained at this chapter. SIP and MGCP related configuration information is also included.

---

**NOTE** H.323, SIP and MGCP VoIP signaling protocols are supported by AddPac Technology's all VoIP products along with VoIP Gateway.

---

## VoIP Protocol

AddPac's VoIP products supports below VoIP signaling protocols.

## H.323 Protocol Application

The APOS configuration examples of the guide are based on H.323 VoIP protocol. For detailed H.323 VoIP signaling protocol configuration, refer to the each related chapter.

---

**NOTE** H.323 VoIP signaling protocol is supported by AddPac Technology's all VoIP products along with VoIP Gateway.

---

## SIP Protocol (Direct Call) Application

VoIP calls with SIP protocol have two kinds of call connection types; direct connection and indirect connection via SIP Proxy Server. The below is the configuration example of Point-to-Point calls in SIP direct call mode.

---

**NOTE** SIP Protocol (Direct Call) application is supported by AddPac Technology's all VoIP products along with VoIP Gateway.

---

### Network Diagram

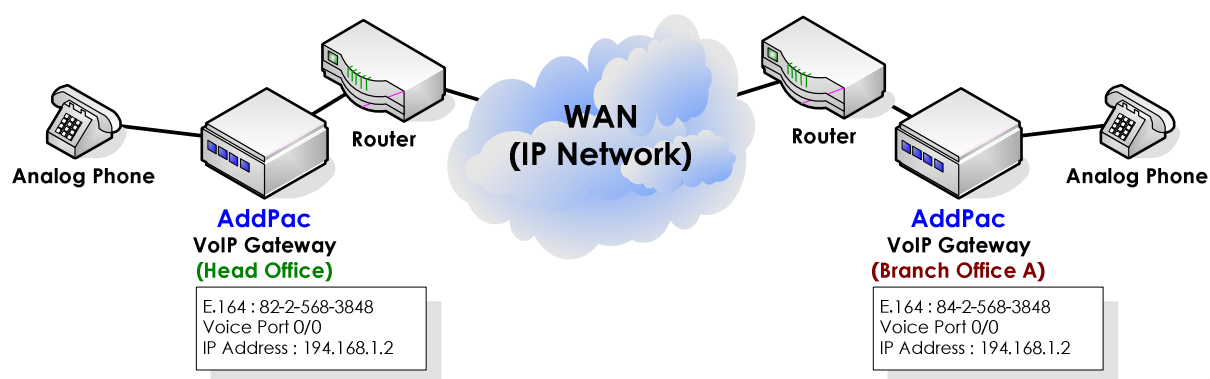

Fig. 5-1 VoIP network diagram of SIP direct call configuration

#### APOS command script (Head office)

```
!
hostname HO
!
interface ether0.0
 ip address 192.168.1.2 255.255.255.0
!
route 0.0.0.0 0.0.0.0 192.168.1.1
!
! Pots peer configuration.
!
dial-peer voice 0 pots
 destination-pattern 8225683848
 port 0/0
!
! Voip peer configuration.
!
dial-peer voice 1000 voip
```

---

```
destination-pattern T
session target 194.168.1.2
  session protocol sip
dtmf-relay h245-alphanumeric
!
voip-interface ether0.0
!
```

---

### APOS command script (Branch A)

```
!
hostname BA
!
interface ether0.0
  ip address 194.168.1.2 255.255.255.0
!
route 0.0.0.0 0.0.0.0 194.168.1.1
!
! Pots peer configuration.
!
dial-peer voice 0 pots
  destination-pattern 8425683848
  port 0/0
!
! Voip peer configuration.
!
dial-peer voice 1000 voip
  destination-pattern T
  session target 192.168.1.2
  session protocol sip
  dtmf-relay h245-alphanumeric
!
voip-interface ether0.0
!
```

---

## Related APOS commands & structure

Configure the below parameters appropriate for the network environment.

- IP address of the VoIP gateway
- Default router
- E.164 for VoIP gateway registration
- IP address of DNS
- IP address of VoIP Peer

To configure the application, follow this procedure.

Step	Commands	Description
1	# <b>config</b> (config)#	Enter APOS global configuration mode.
2	(config)# (config)# <b>sip-ua</b> (config-sip-ua)# ?  no                   set to default configuration register            try registration to sip registrar signalling-port    set SIP signalling port (default 5060) sip-server         Configure a SIP Server Interface sip-username       Set Username of SIP User Agent sip-password       Set Password of SIP User Agent timeout            Set timeout value end                 Go to Top menu exit                Exit from the EXEC	Enter SIP User Agent Configuration mode. Enter "?" to check the possible commands.
3	(config-sip-ua)# <b>exit</b> (config)#	Exit from SIP User Agent Configuration mode.
4	(config)# <b>exit</b> #	Exits from APOS global configuration mode.

Step	Commands	Description
1	HO(config-dialpeer-pots-0)# <b>dial-peer voice</b> <b>1000 voip</b>	Create a VoIP dial peer for VoIP call setup. The tag number "1000" is assigned for the VoIP peer. (The valid tag number range is "0 ~ 65,535" and typically it starts from "1000".)
2	HO(config-dialpeer-voip-1000)# <b>destination-</b> <b>pattern T</b>	
3	HO(config-dialpeer-voip-1000)# <b>session target</b> <b>194.168.1.2</b>	
4	HO(config-dialpeer-voip-1000)# <b>session</b> <b>protocol sip</b>	
5	HO(config-dialpeer-voip-1000)# <b>dtmf-relay</b> <b>h245-alphanumeric</b>	Define the DTMF transmission type as "H. 245 Alphanumeric".



## SIP Protocol (Indirect, Proxy Server) Application

VoIP calls with SIP signaling protocol have two kinds of call connection type; direct connection and indirect connection via SIP Proxy Server. The below is the configuration example of Point-to-point SIP indirect calls made via SIP Proxy Server.

**NOTE** SIP Protocol (Indirect, Proxy Server) application is supported by AddPac Technology's all VoIP products along with VoIP Gateway.

### Network Diagram

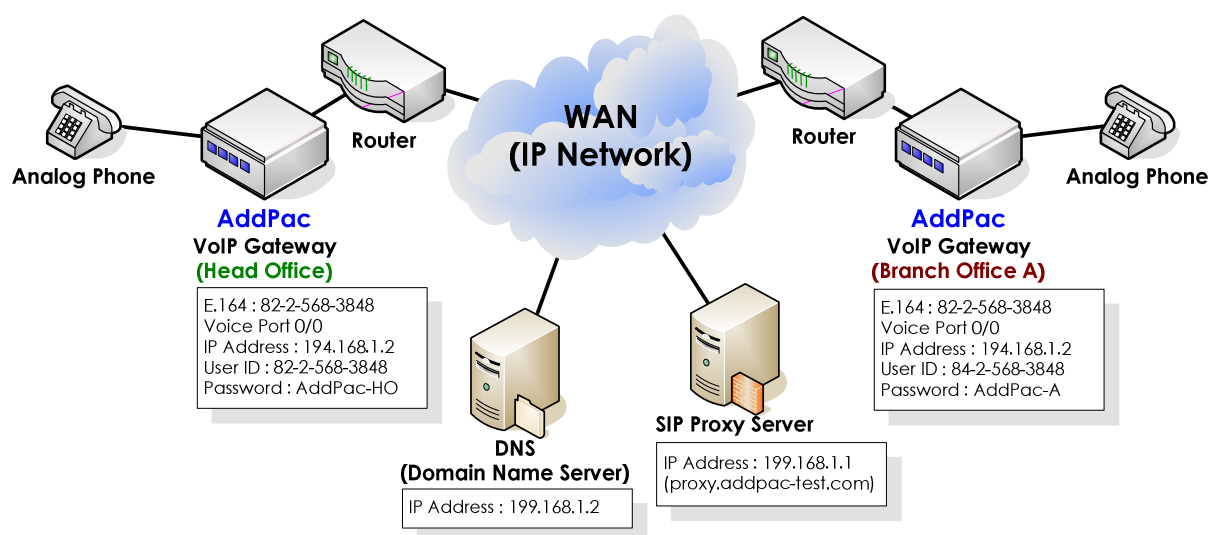

Fig. 5-2 VoIP network diagram of SIP indirect calls via SIP Proxy server

#### APOS command script (Head office)

```
!
hostname HO
!
interface ether0.0
 ip address 192.168.1.2 255.255.255.0
!
route 0.0.0.0 0.0.0.0 192.168.1.1
!
dnshost nameserver 199.168.1.2
!
! Pots peer configuration.
!
dial-peer voice 0 pots
 destination-pattern 8225683848
 port 0/0
!
```

---

```
!  
!  
! Voip peer configuration.  
!  
dial-peer voice 1000 voip  
  destination-pattern T  
  session target sip-server  
  session protocol sip  
dtmf-relay h245-alphanumeric  
!  
!! Gateway configuration.  
!  
!  
! SIP UA configuration.  
!  
sip-ua  
  sip-username 8225683848  
  sip-password AddPac-HO  
  sip-server proxy.addpac-test.com  
  register e164  
!  
voip-interface ether0.0  
!
```

---

#### APOS command script (Branch A)

```
!  
hostname BA  
!  
interface ether0.0  
  ip address 194.168.1.2 255.255.255.0  
!  
route 0.0.0.0 0.0.0.0 194.168.1.1  
!  
dnshost nameserver 199.168.1.2  
!  
! Pots peer configuration.  
!  
dial-peer voice 0 pots  
  destination-pattern 8425683848  
  port 0/0  
!  
!  
!  
! Voip peer configuration.  
!  
dial-peer voice 1000 voip  
  destination-pattern T  
  session target sip-server  
  session protocol sip  
  
  dtmf-relay h245-alphanumeric  
!  
!! Gateway configuration.  
!  
!  
! SIP UA configuration.  
!
```

---

```

sip-ua
  sip-username 8425683848
  sip-password AddPac-A
  sip-server proxy.addpac-test.com
register e164
!
voip-interface ether0.0
!

```

## Related APOS commands & structure

This application is similar to H.323 application using GK, which is typical configuration of commercial VoIP network, or middle and large scale enterprise VoIP network. Each end point SIP terminal requires authentication from SIP Server to establish calls. To use domain name instead of IP address, Domain Name Server (DNS) is required.

The below example uses DNS to establish calls.

Configure the below parameters appropriate for the network environment.

- IP address of VoIP gateway
- Default router
- E.164 for registering gw
- IP address of DNS
- IP address of SIP Proxy Server
- SIP user name
- SIP password

To configure the application, follow this procedure.

Step	Commands	Description
1	HO(config)# <b>dnshost nameserver 199.168.1.2</b>	
2	HO(config-dialpeer-pots-0)# <b>dial-peer voice 1000 voip</b>	Create a VoIP dial peer for VoIP call setup. The tag number "1000" is assigned for the VoIP peer. (The valid tag number range is "0 ~ 65,535")

		and typically it starts from "1000".)
3	HO(config-dialpeer-voip-1000)# <b>destination-pattern T</b>	
4	HO(config-dialpeer-voip-1000)# <b>session target sip-server</b>	
5	HO(config-dialpeer-voip-1000)# <b>session protocol sip</b>	
6	HO(config-dialpeer-voip-1000)# <b>dtmf-relay h245-Alphanumeric</b>	Define the DTMF transmission type as "H. 245 Alphanumeric".
7	HO(config-dialpeer-voip-1000)# <b>sip-ua</b>	
8	HO(config-sip-ua)# <b>sip-username 8225683848</b>	
9	HO(config-sip-ua)# <b>sip-password AddPac-HO</b>	
10	HO(config-sip-ua)# <b>sip-server proxy.addpac-test.com</b>	
11	HO(config-sip-ua)# <b>register e164</b>	Resiger E.164 number

## Username/Password Registration of SIP Dial-Peer

A separate username and password can be assigned for each dial-peer. Until now, the gateway with multiple E.164 numbers is only assigned with one username and password, and the separate authentication of each E.164 is not applicable. However, APOS v 7.0 supports username and password registration function.

That is, if the user assigns e.164 100 at dial-peer 1, e.164 200 at dial-peer 2, and also assigns usernames and passwords for each dial-peer, then the gateway sends Registration Request to SIP server two different times for each dial-peer. Thus separate registration process is possible for each dial-peer.

This newly added command is the sub-command of dial-peer command, and the same command already exists as the sub-command of the sip-ua command. That's why the users are requested to pay attention to the priority. When the user name and password is configured at both dial-peer command and sip-ua command, the sip-ua command is only applied due to its higher priority. Thus the user name and password setting of the dial-peer

command is ignored.

That means, if sip-username and sip-password of sip-ua is assigned, and sip-username and sip-password of dial-peer is also assigned at the same time, APOS gives the higher priority to the global configuration that affects the entire gateway. Therefore, the username and password setting at dial-peer is ignored.

## Related APOS commands & structure

### dial-peer command

```
(config)# dial-peer voice 0 pots
(config-dialpeer-pots-0)#
    user-name          set username of dial peer
    user-password      set password of dial peer
```

```
(config-dialpeer-pots-0)# user-name <string>
(config-dialpeer-pots-0)# user-password <string>
```

### sip-ua command

```
(config)# sip-ua
(config-sip-ua)#
    sip-username      Set Username of SIP User Agent
    sip-password      Set Password of SIP User Agent
```

# MGCP Protocol Application

This chapters provides information on APOS commands of MGCP VoIP protocol. For further details, refer to APOS Operation Guide.

**NOTE** MGCP Protocol application is supported by AddPac Technology's all VoIP products along with VoIP Gateway.

## Network Diagram

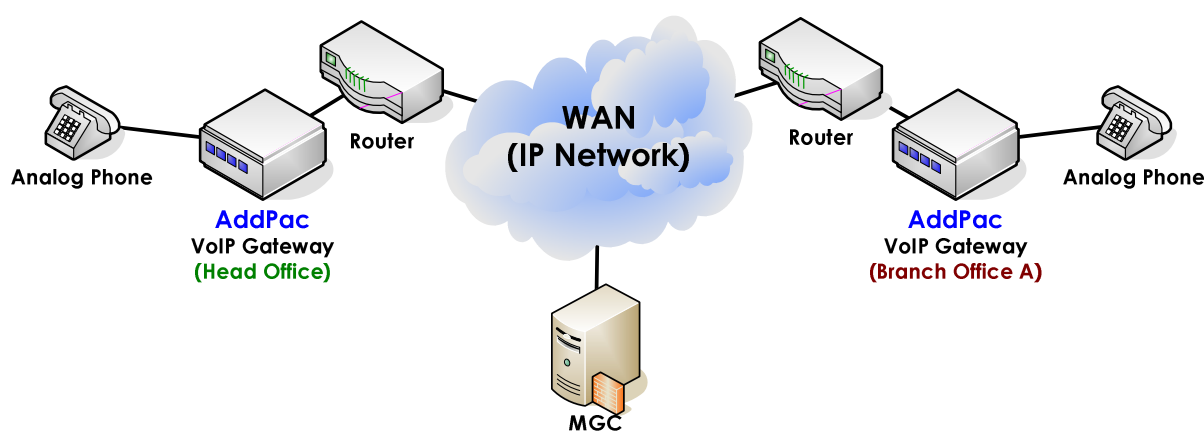

Fig. 5-3 VoIP network diagram based on MGCP protocol

## Main APOS Commands for MGCP Protocol

### Enters MGCP configuration mode

Step	Commands	Description
1	# config (config)#	Enter APOS global configuration mode.
2	(config)# (config)# <b>MGCP</b> (config-MGCP)# ?  no register call-agent default-package dtmf-relay restart-delay timeout end	Enter MGCP Configuration mode. Check the related commands by entering "?".  set to default configuration Enable MGCP Specify address of call-agent Select the Default Package Capability Configure mgcp dtmf-relay Specify the Restart Delay timer value Set timeout value Go to Top menu

	<code>exit</code>	Exit from the EXEC
<b>3</b>	<code>(config-MGCP)# exit</code> <code>(config)#</code>	Exit from MGCP configuration mode.
<b>4</b>	<code>(config)# exit</code> <code>#</code>	Exit from APOS global configuration mode.

## MGCP Register Command

Step	Commands	Description
<b>1</b>	<code># config</code> <code>(config)#</code>	Enter APOS global configuration mode.
<b>2</b>	<code>(config)#</code> <code>(config)# MGCP</code> <code>(config-MGCP)#</code>	Enter MGCP Configuration mode.
<b>3</b>	<code>(config-MGCP)# register ?</code> <code>&lt;0-65536&gt; Enable MGCP with user specified UDP port number</code> <code>&lt;cr&gt;</code> <code>(config-MGCP)#</code> <code>(config-MGCP)# exit</code> <code>(config)#</code> <code>(config)#</code> <code>(config)#</code>	Register command is for MGC registration. It sends RSIP (restart) message to MGC. Also, the local port no. of MG(Media Gateway) can be configured.
<b>4</b>	<code>(config)# exit</code> <code>#</code>	Exit from APOS global configuration mode.

## MGCP Call Agent Command

Step	Commands	Description
<b>1</b>	<code># config</code> <code>(config)#</code>	Enter APOS global configuration mode.
<b>2</b>	<code>(config)#</code> <code>(config)# MGCP</code> <code>(config-MGCP)#</code>	Enter MGCP Configuration mode.
<b>3</b>	<code>(config-MGCP)# call-agent ?</code> <code>alias set Hostname or IP address of the call-agent</code> <code>(config-MGCP)# call-agent 1.1.1.1 ?</code> <code>&lt;0-65536&gt; port number (default 2427)</code> <code>&lt;cr&gt;</code> <code>(config-MGCP)# call-agent 1.1.1.1 2427</code>	Assign IP address or domain name of MGC or Soft Switch. Also, the port no. of MGC can be configured.

---

	<0-254>    priority (default 128)	
	(config-MGCP)# <b>exit</b>	
	(config)#	
	(config)#	
<b>4</b>	(config)# <b>exit</b> #	Exit from APOS global configuration mode.

---

## MGCP Package Command

Step	Commands	Description
1	# config (config)#	Enter APOS global configuration mode.
2	(config)# (config)# <b>MGCP</b> (config-MGCP)# <b>default-package ?</b> as-package        Select the Announcement Server Package dtmf-package     Select the DTMF Package gm-package        Select the Generic Media Package hs-package        Select the Handset Package line-package      Select the Line Package trunk-package    Select the Trunk Package	Configure the default package for the Media Gateway.  Default: Line-package
3	(config-MGCP)# <b>exit</b> (config)#	Exit from MGCP configuration mode.
4	(config)# <b>exit</b> #	Exit from APOS global configuration mode.

---

## MGCP DTMF Relay Command

Step	Commands	Description
1	# config (config)#	Enter APOS global configuration mode.
2	(config)# (config)# <b>MGCP</b> (config-MGCP)#	Enter MGCP Configuration mode.
3	(config-MGCP)# <b>dtmf-relay ?</b> rtp-2833         DTMF relay by RTP payload defined by RFC 2833 out-of-band      DTMF relay by out-of-band signal (config)#	Select DTMF Relay type.

---



<b>4</b>	(config-mgcp)# <b>no dtmf-relay</b> (config)#	Assign DTMF relay as in-band type.
<b>5</b>	(config-mgcp)# <b>dtmf-relay rtp-2833</b> (config)#	Assign DTMF relay according to the RFC-2833 standard.
<b>6</b>	(config-mgcp)# <b>dtmf-relay out-of-band</b> (config)# (config)#	Assign DTMF relay as out-of-band type. DTMF is transmitted with NTFY message.
<b>7</b>	(config)# <b>exit</b> #	Exit from APOS global configuration mode.

## MGCP Restart Relay command

Step	Commands	Description
<b>1</b>	# config (config)#	Enter APOS global configuration mode.
<b>2</b>	(config)# (config)# <b>MGCP</b> (config-MGCP)#	Enter MGCP Configuration mode.
<b>3</b>	(config-MGCP)# <b>restart-delay ?</b> <0 - 500>      Select the Restart Delay timer value (sec) (config-MGCP)# (config-MGCP)# <b>exit</b> (config)# (config)# (config)#	Configure RSIP message transmission delay after executing register command. For examples, if the delay is "10sec", the RSIP message is sent in 10 seconds after executing register command at MG. ( Default: 5sec)
<b>4</b>	(config)# <b>exit</b> #	Exit from APOS global configuration mode.

## MGCP Timeout Command

MGCP Timeout commands are: Tretry, Tmax, Thist. Trtry configures message retransmission time, and the default is 4 sec. Tmax configures the maximum Tretry time. The message retransmission

time should not be longer than Thist time. The default value is 20 sec. The message is retransmitted at every 4 seconds within the Tmax time (20 seconds). Thist configures the max. retransmission time. The default is 30 sec. After Tmax timer is expired, it stands by for 30 seconds.

Step	Commands	Description
1	# <b>config</b> (config)#	Enter APOS global configuration mode..
2	(config)# (config)# <b>MGCP</b> (config-MGCP)# <b>timeout ?</b> tretry set MGCP retry timeout value (msec) thist set MGCP hist timeout value (sec) tmax set MGCP max timeout value (sec)	Configure MGCP Timeout values. Message retry timeout Max. message retransmission time Max. Tretry time
3	(config-MGCP)# <b>exit</b> (config)#	Exits from MGCP configuration mode.
4	(config)# <b>exit</b> #	Exits from APOS global configuration mode.

### MGCP Voice port configuration command

Step	Commands	Description
1	# <b>config</b> (config)#	Enter APOS global configuration mode.
2	(config)# (config)# <b>MGCP</b> (config-MGCP)#	Enter MGCP Configuration mode.
3	(config-MGCP)# <b>dial-peer voice 0 pots</b> (config-dialpeer-pots-0)#	
4	(config-dialpeer-pots-0)# <b>port 0/0</b> (config-dialpeer-pots-0)# <b>application mgcpapp</b> (config-dialpeer-pots-0)#	Assign a voice port operating with MGCP.
5	(config-dialpeer-pots-0)# <b>exit</b> (config)#	Exit from Voice Port Configuration mode.
6	(config)# <b>exit</b> #	Exit from APOS global configuration mode.

## MGCP End-point ID configuration command

The MGCP End-point format is "**aaln/slot-number/port-number@domain-name**". The APOS command for hostname configuration can be used for domain name configuration.

With the domain name, "111.222.333.444", the End-point ID of voice port 0/0 is **aaln/0/0@111.222.333.444**.

Step	Commands	Description
1	# config (config)#	Enter APOS global configuration mode..
2	(config)# (config)# <b>hostname ?</b>  <hostname> Hostname of this system (config-MGCP)#	Inquire for Hasntname command.
3	(config)# <b>hostname 111.222.333.444</b> 111.222.333.444 (config)# 111.222.333.444 (config)# <b>exit</b>	Assign the domain name.
4	111.222.333.444# <b>exit</b> #	Exit from APOS global configuration mode..

---

---

# Chapter 6. Voice Interface Configuration

---

---

This chapter provides information on VoIP Gateway voice interface configuration of gain/tone control and various voice interfaces such as FXS, FXO and E&M.

## Input & Output Gain configuration

This part provides information on APOS commands and parameters commonly used for voice interface configuration. Make sure to consider all the equipment including PBX on the network when configuring input and output gain of the VoIP gateway.

At the calling party's viewpoint, the input gain can be considered as the volume of a microphone. If the voice volume on the called party is too loud, reduce the input gain of the gateway. On the other hands, the out put gain can be considered as the volume of a speakerphone. If the volume of the phone or PBX connected to VoIP gateway is too loud, reduce the output gain.

The default value is "0". However, considering the natural decrease on PSTN, set the value "+3dB" or "+6dB".

---

**NOTE** The default value doesn't consider specific network condition of each user. If the voice volume is too loud or there is echo and noise, decrease the input and output gain to eliminate the background noise.

---

---

**NOTE** This application is supported by AddPac Technology's all VoIP products along with VoIP Gateway.

---

## Network Diagram

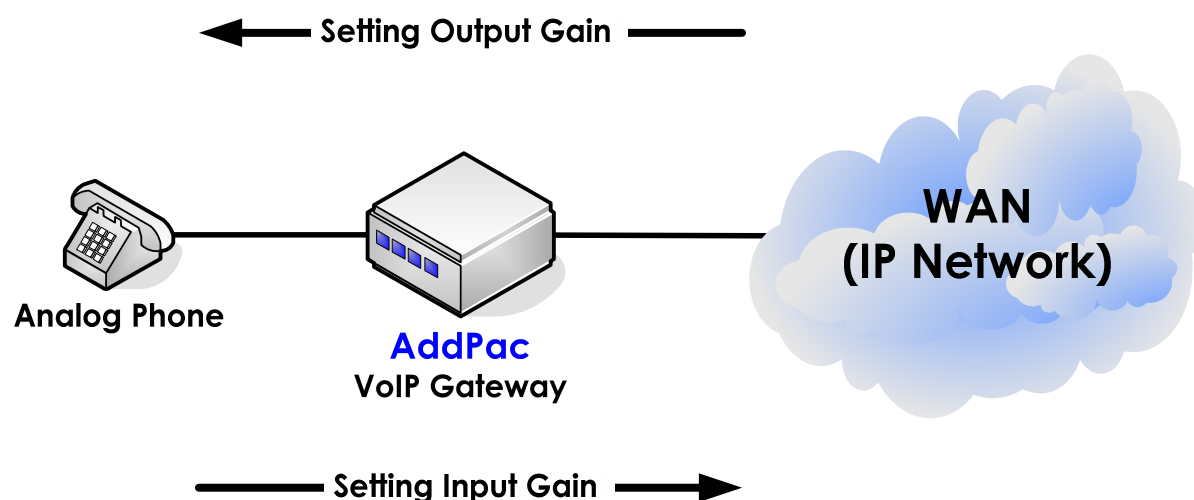

Fig. 6-1 VoIP Gateway Input/Output gain

Input gain increases or decreases the voice volume coming to the VoIP gateway from the voice ports. Also, the out gain increases or decreases the voice volume coming from the IP network to the VOIP gateway.

The default input/output gain value is 0dB. The valid range is "-18dB~ +8dB".

### APOS command script

```
!
hostname H0
!
interface ether0.0
 ip address 192.168.1.1 255.255.255.0
!
!
voice-port 1/0
 input gain 2
 output gain 3
!
```

## Related APOS commands & structure

Configure the below parameters appropriate for the network environment.

- Input and output gain value

To configure the gain, follow this procedure.

Step	Commands	Description
1	HO(config-ether0.0)# <b>voice-port 1/0</b>	Configure the voice port 1/0.
2	HO(config-voice-port-1/0)# <b>input gain 2</b> HO(config-voice-port-1/0)#	Increase the input again by 2 dB.
3	HO(config-voice-port-1/0)# <b>output gain 3</b> HO(config-voice-port-1/0)#	Increase the output gain by 3dB.

# Tone Configuration

Various tones such as dial tone, busy tone, reorder tone, ringback tone, linelock tone and etc can be configured by APOS commands. At this guide, the reorder tone configuration is provided as an example.

**NOTE** This application is supported by AddPac Technology's all VoIP products along with VoIP Gateway.

## Network Diagram

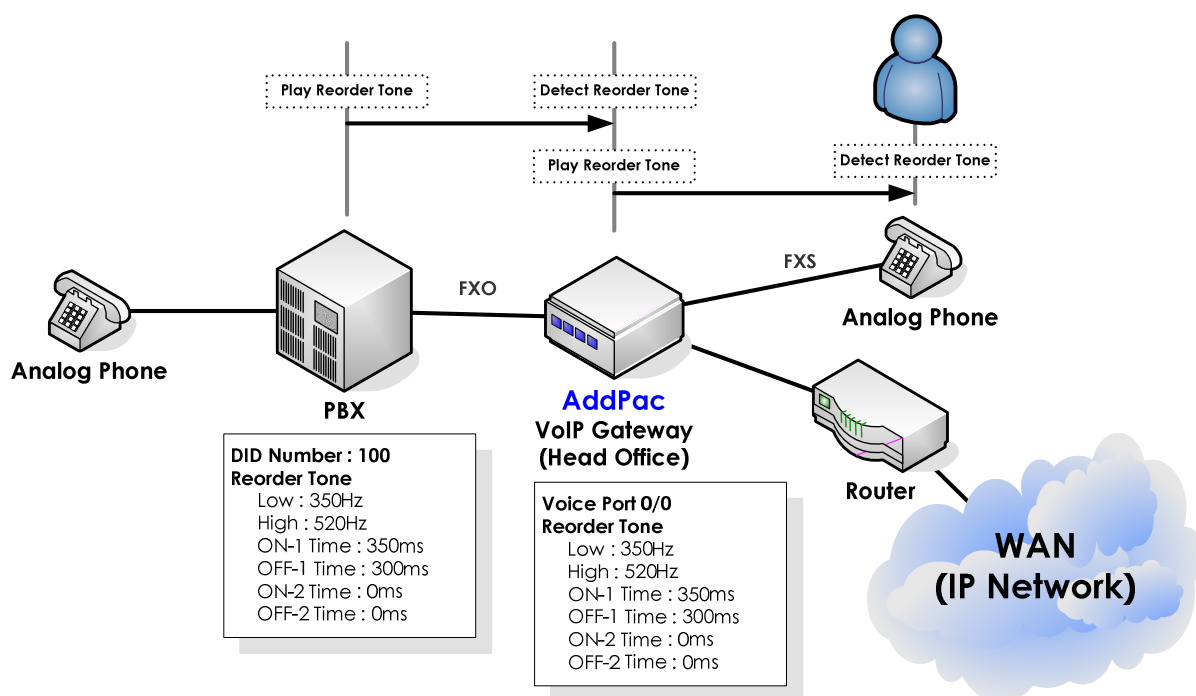

**Fig. 6-2 VoIP gateway tone setting**

The above figure is an APOS configuration example of reorder tone between PBX and a head office. Reorder tone is a tone used to terminate calls between analog ports of PBX or VoIP Gateway. With the wrong tone values, the call cannot be terminated. Generally, PBXs and PSTN follow the tone standard by the government.

However, tone values of some PBXs or the extension lines of PBXs are non-standard, so the call cannot be terminated while interoperating with VoIP GW. In this case, modify the tone values of VoIP GW.

When the reorder tone is set, FXO interface detects the tone, and FXS interface plays the tone. Use the "tone" command and its options for the configuration of various tones.

#### APOS command script

```
!
hostname HO
!
interface ether0.0
 ip address 192.168.1.1 255.255.255.0
!
!
!
dial-peer voice 0 pots
 destination-pattern 5683847
 port 0/0
!
dial-peer voice 1000 voip
 destination-pattern 5683848
 session target 193.158.1.2
 dtmf-relay h245-alphanumeric
!
! Tones
voice class reorder-tone 350 520 350 300 0 0 -12
!
voip-interface ether0.0
!
```

#### APOS command script (Tone Configuration Verification)

```
#
# show tone
Tag   Low(Hz)   High(Hz)   On1 (ms)   Off1 (ms)   On2 (ms)   Off2 (ms)   dBm   Description
-----
-     350       440        10000      0           0          0        -18   Dial tone
-     440       480        1000       2000        0          0        -12   RingBack tone
-     480       620        500        500         0          0        -12   LineBusy tone
-     350       520        350        300         0          0        -12   Reorder tone
-     1400      2060       100        100         0          0         0     LineLock tone
#
```

## Related APOS commands & structure

Configure the below parameters appropriate for the network environment.



- The frequency of reorder tone

To configure polarity inverse, follow this procedure.

Step	Commands	Description
1	HO(config-dialpeer-voip-1000)# <b>voice class</b> <b>reorder-tone 350 520 350 300 0 0 -12</b>	

# E1/T1 Voice Interface Configuration/ ISDN-PRI

This chapter offers information about the common APOS commands for E1/T1 configuration. For more detailed configuration and for parts are not mentioned here, refer to APOS Operation Guide.

The common and basic commands related to E1/T1 ISDN-PRI configuration are mentioned below.

**NOTE** This configuration is applied to AddPac Technology's all VoIP products along with VoIP Gateway which can be equipped with digital E1/T1 voice interface module.

## Network Diagram

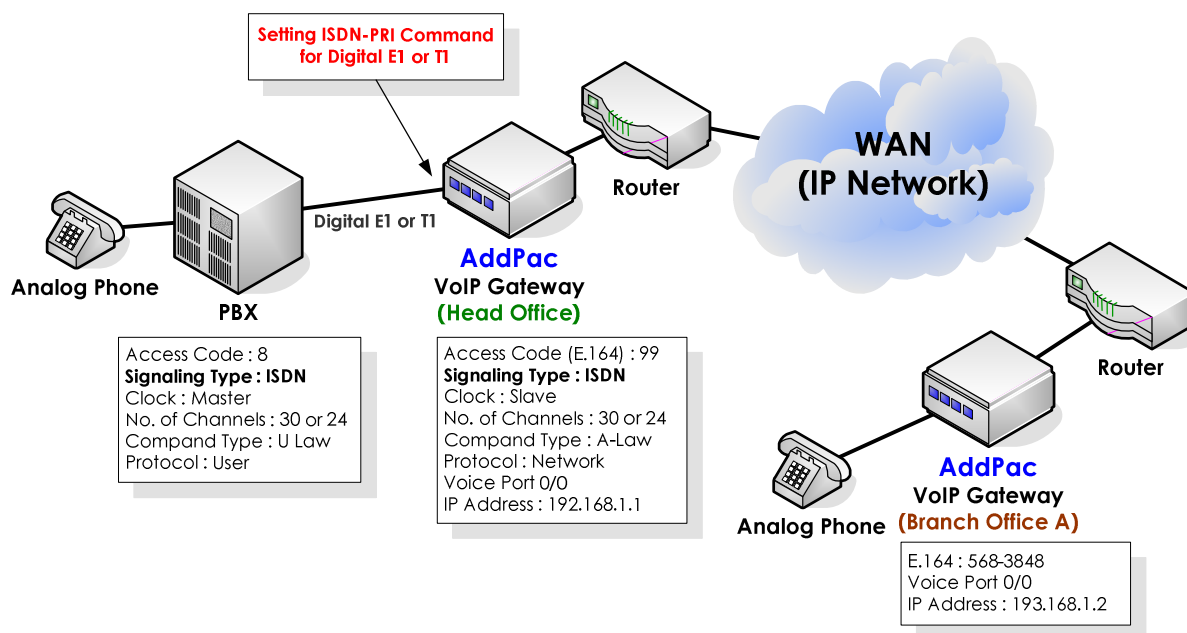

**Fig. 6-3 VoIP gateway digital E1/T1 ISDN-PRI**

The digital E1/T1 voice interface configurations can be divided by the signaling types; ISDN –PRI, R2 & DTMF. At the example, the PBX and VoIP gateway at the head office are operated with ISDN-PRI signaling type. In case of ISDN-PRI, the interface protocol between PBX and PBX or between PBX and VoIP gateway should be a pair of

"network side" and "user". As you can see from the above example, PBX operates as "user side" and the VoIP at the head office operates as "network." Also, the compand-type of PBX and the VoIP GW should be configured same according to the PCM type (A-law or U-law).

The below is the default parameters of digital E1 ISDN-PRI of the VoIP Gateway.

- Signaling type: Un-defined
- Clock: Master
- No. of channels: None
- Compand-type : A-law
- Protocol: network

#### APOS command script

```
!
hostname HO
!
interface ether0.0
 ip address 192.168.1.1 255.255.255.0
!
! PRI controller configuration.
!
controller e1(t1) 0/0
signalling-type isdn
channel-group timeslots 1-31 0
isdn protocol-emulate network
!
voice-port 0/0
! E1(t1)
 compand-type u-law
!
dial-peer voice 0 pots
 destination-pattern 99T
 port 0/0
!
dial-peer voice 1000 voip
 destination-pattern 5683848
 session target 193.158.1.2
 dtmf-relay h245-alphanumeric
!
voip-interface ether0.0
!
```

#### APOS command script (Configuration Verification)

```
HO# show controller 0/0
Controller T1 slot(0)/port(0)
```

---

```

T1 Link is UP
  No Alarm detected.
  Applique type is Channelized T1.
  Framing is SF, Line Code is AMI, Cable Length is Short 110.
  Signalling type is ISDN PRI.
  0 Line Code Violations, 0 Framing Bit Errors
  0 Out Of Frame Errors, 0 Bit Errors
  6 Frames Received, 6 Frames Transmitted
signalling type = isdn
clock source = master
channel group 0 = 1-24
                        1           2           3
allocated timeslots = YYYYYYYYYYYYYYYYYYYYYYYYYYNNNNNNNNNN
outgoing barred channel group =
channel order = descending
b-channel negotiation = exclusive
overlap receiving = enabled
protocol side = user
R2 get calling number = disabled
ISDN virtual connect = disabled
T1 cable length = short 110
T1 framing = sf
T1 line code = ami
T1 CAS type = immediate
ISDN Layer 2 is UP
ISDN Values
  ISDN Layer 2 values
    k      = 7
    N200 = 3
    N201 = 260
    T200 = 1 seconds
    T203 = 10 seconds
  ISDN Layer 3 values
    T301 = 180 seconds
    T302 = 15 seconds
    T303 = 4 seconds
    T305 = 30 seconds
    T306 = 30 seconds
    T308 = 4 seconds
    T310 = 10 seconds
    T313 = 4 seconds
    T316 = 120 seconds
    T309 = 90 seconds
    N303 = 1

```

---

## Related APOS commands & structure

Configure the below parameters appropriate for the network environment.

Signaling-type

No. of Channel-groups  
 Clock type  
 Comband-type  
 Protocol type

To configure the application, follow this procedure.

Step	Commands	Description
1	HO(config-ether0.0)# <b>controller e1(t1) 0/0</b>	
2	HO(config-ether0.0)# <b>signalling-type isdn</b>	
3	HO(config-ether0.0)# <b>channel-group timeslots 1-31</b> 0	
4	HO(config-ether0.0)# <b>isdn protocol-emulate network</b>	
5	HO(config-ether0.0)# <b>voice-port 0/0</b>	Enter Voice Port Configuration mode.
6	HO(config-voice-port-0/0)# <b>comband-type u-law</b>	

# E1/T1 Voice Interface Configuration/ R2 DTMF

The popular E1/T1- R2/DTMF configuration commands are explained at this chapter.

**NOTE** This application is supported by AddPac Technology's all VoIP products along with VoIP Gateway which can be equipped with digital E1/T1 voice interface module.

## Network Diagram

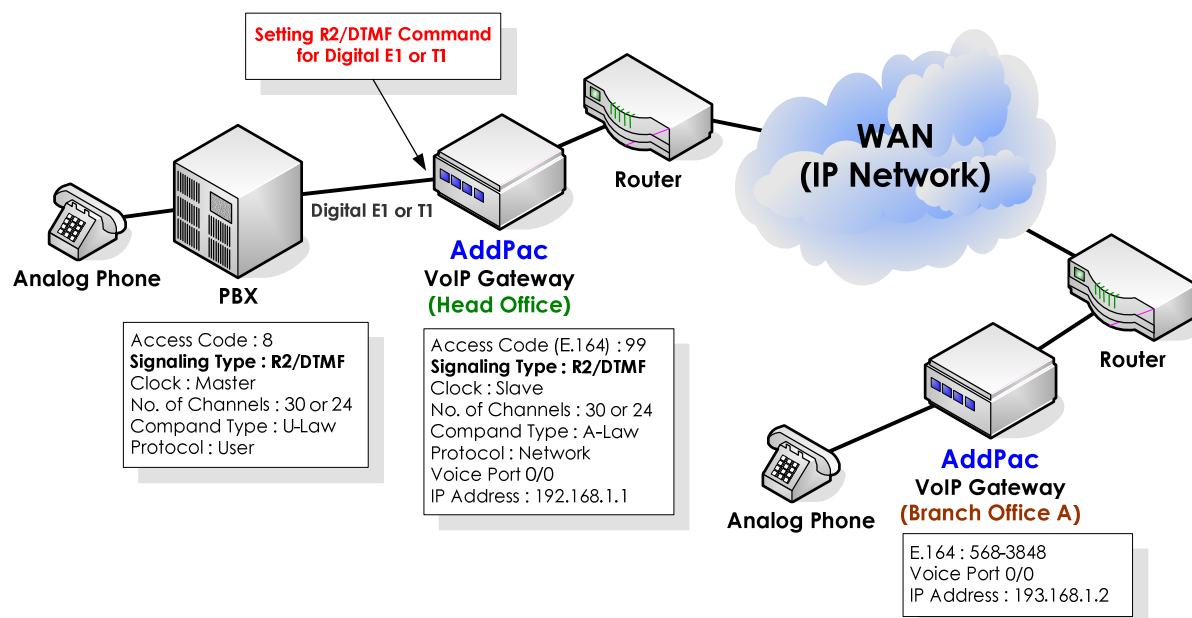

**Fig. 6-4 VoIP gateway digital E1/T1 R2/DTMF**

In the above example, the PBX and VoIP GW at the head office are operated with R2/DTMF signaling type. In case of R2/DTMF, only signal and channel configuration is required, and the preconfigured ISDN-PRI becomes invalid.

Also, the compand-type of PBX and the VoIP GW should be configured same according to the PCM type (A-law or U-law).

The below is the default parameters of digital E1 ISDN-PRI of the VoIP Gateway.

- Signaling type: Un-defined
- No. of channels: None
- Compand-type : A-law

### APOS command script

```

!
hostname HO
!
interface ether0.0
 ip address 192.168.1.1 255.255.255.0
!
! PRI controller configuration.
!
controller e1(t1) 0/0
signalling-type r2/dtmf
Clock slave
channel-group timeslots 1-31 0
!
voice-port 0/0 0
! E1(t1)
 compand-type u-law
!
dial-peer voice 0 pots
 destination-pattern 99T
 port 0/0
!
dial-peer voice 1000 voip
 destination-pattern 5683848
 session target 193.158.1.2
 dtmf-relay h245-alphanumeric
!
voip-interface ether0.0
!

```

### APOS command script (Configuration Verification)

```

HO# show controller 0/0
Controller T1 slot(0)/port(0)
  T1 Link is UP
    No Alarm detected.
    Applique type is Channelized T1.
    Framing is SF, Line Code is AMI, Cable Length is Short 110.
    Signalling type is R2-MFC.
    7967 Line Code Violations, 2 Framing Bit Errors
    1 Out Of Frame Errors, 2 Bit Errors
  signalling type = r2
  clock source = slave
  channel group 0 = 1-24
                        1           2           3
  allocated timeslots = YYYYYYYYYYYYYYYYYYYYYYYYYYNNNNNNNN
  outgoing barred channel group =
  channel order = descending
  b-channel negotiation = exclusive

```

---

```
overlap receiving = enabled
protocol side = network
R2 get calling number = disabled
ISDN virtual connect = disabled
T1 cable length = short 110
T1 framing = sf
T1 line code = ami
T1 CAS type = immediate
```

---

## Related APOS commands & structure

Configure the below parameters appropriate for the network environment.

- Signaling type
- No. of channel groups
- Clock type
- Compand type
- Protocol type

To configure the application, follow this procedure.

Step	Commands	Description
1	HO(config-ether0.0)# <b>controller e1(t1) 0/0</b>	
2	HO(config-ether0.0)# <b>signalling-type r2/dtmf</b>	
3	HO(config-ether0.0)# <b>Clock slave</b>	
4	HO(config-ether0.0)# <b>channel-group timeslots 1-31 0</b>	
5	HO(config-ether0.0)# <b>voice-port 0/0</b>	
6	HO(config)# <b>compand-type u-law</b>	



## FXS/FXO Voice Interface configuration for caller ID

This part is related to FXO/FXO voice interface configuration. Even though this is not a commonly required configuration, it needs to be done at the initial configuration of VoIP gateway. For more detailed information on this configuration, refer to APOS Operation Guide.

The general information on Caller ID is provided below. FXS voice interface only detects caller ID and FXO voice interface generates caller ID.

---

**NOTE** This application is supported by AddPac Technology's all VoIP products along with VoIP Gateway which can be equipped with FXS/FXO voice interface and modules.

---

### Network Diagram

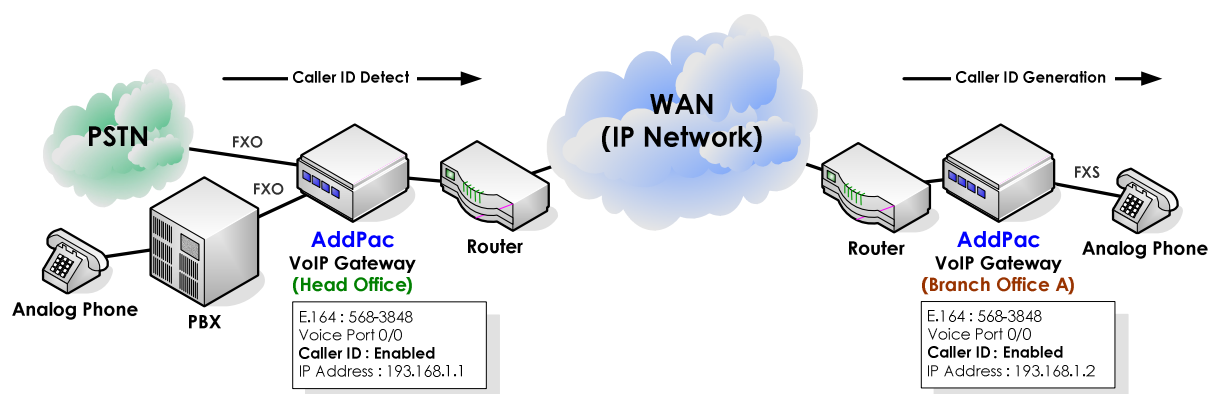

**Fig. 6-5 VoIP gateway caller- ID feature**

This part explains Caller ID detection on FXS analog interface and Caller ID generation of FXO analog interface. At the head office, the FXO port of the VoIP Gateway connected to PBX, detects caller ID and sends it to branch office A. On the other hand, the FXS voice interface generates caller ID according to the received information. The caller ID message is displayed on the end terminal such as telephones.

---

**APOS command script (Head Office)**

---

```
!  
hostname HO  
!  
interface ether0.0  
  ip address 192.168.1.1 255.255.255.0  
!  
!  
voice-port 0/0  
! FXO  
  caller-id enable  
!  
!  
dial-peer voice 0 pots  
  destination-pattern 5683847  
  port 0/0  
!  
dial-peer voice 1000 voip  
  destination-pattern 5683848  
  session target 193.158.1.2  
  dtmf-relay h245-alphanumeric  
!  
voip-interface ether0.0  
!
```

---

---

**APOS command script (Head Office without forward digits)**

---

```
!  
hostname HO  
!  
interface ether0.0  
  ip address 194.168.1.2 255.255.255.0  
!  
!  
voice-port 0/0  
! FXO  
  caller-id enable  
!  
!  
dial-peer voice 0 pots  
  destination-pattern T  
  port 0/0  
!  
dial-peer voice 1000 voip  
  destination-pattern 5678  
  session target 193.168.1.2  
  dtmf-relay h245-alphanumeric  
!  
voip-interface ether0.0  
!
```

---

---

**APOS command script (Branch A)**

---

```
!  
hostname BA  
!
```

---

---

```
interface ether0.0
  ip address 193.168.1.1 255.255.255.0
!
!
!
voice-port 0/0
! FXS
  caller-id enable
!
!
dial-peer voice 0 pots
destination-pattern 5683848
port 1/0
!
dial-peer voice 1000 voip
  destination-pattern 99T
  session target 192.158.1.2
  dtmf-relay h245-alphanumeric
!
voip-interface ether0.0
!
```

---

### APOS command script (Head Office-Configuration Verification)

```
HO# show voice port 0/0
Voice port slot(0)/port(0)
  line type = FXS
  status = Idle
  input gain = 0 db
  output gain = 0 db
  ring frequency = 25 Hz
  ring cadence = 1000 msec on, 2000 msec off
  polarity inverse = disabled
  tie connection = none
  description =
  translate incoming called-number = -1
  translate incoming calling-number = -1
  comfort noise generation = enabled
  dial tone generation = enabled
  echo cancellation = enabled
  announcement = enabled
  low dtmf gain = -8
  high dtmf gain = -5
  caller ID = enabled
  caller ID type = bellcore
  caller ID NAME = enabled
  busyout action = none
  associated call number = -1
```

---

## Related APOS commands & structure

Configure the below parameters appropriate for the network

environment.

None

To configure the application, follow this procedure.

Step	Commands	Description
1	HO(config-ether0.0)# <b>voice-port</b> 0/0	
2	HO(config-voice-port-0/0)# <b>caller-id enable</b>	Enable Caller-ID.
3	HO(config-voice-port-0/0)# <b>dial-peer voice 0 POTS</b>	
4	HO(config-dialpeer-pots-0)# <b>forward-digit from</b> 0	For example, the received number is 1234, the gateway transfers the number to the PBX.
4	HO(config-dialpeer-pots-0)# <b>destination-pattern</b> 1234	
5	HO(config-dialpeer-pots-0)# <b>port</b> 0/0	

# FXS/FXO Voice Interface configuration for polarity-inverse

Polarity-Inverse feature of FXS port initiates inversion signal to PBX and the PBX starts billing when the inversion signal is detected.

**NOTE** This application is supported by AddPac Technology's all VoIP products along with VoIP Gateway which can be equipped with FXS/FXO voice interface and modules.

## Network Diagram

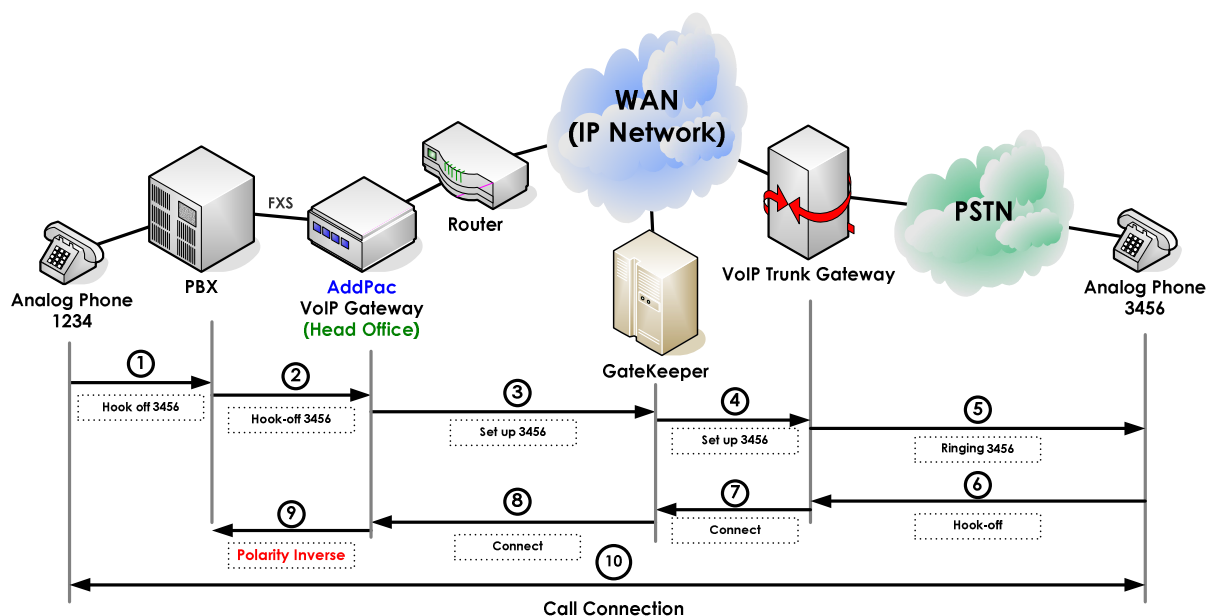

Fig. 6-6 VoIP gateway polarity inverse feature on FXS port

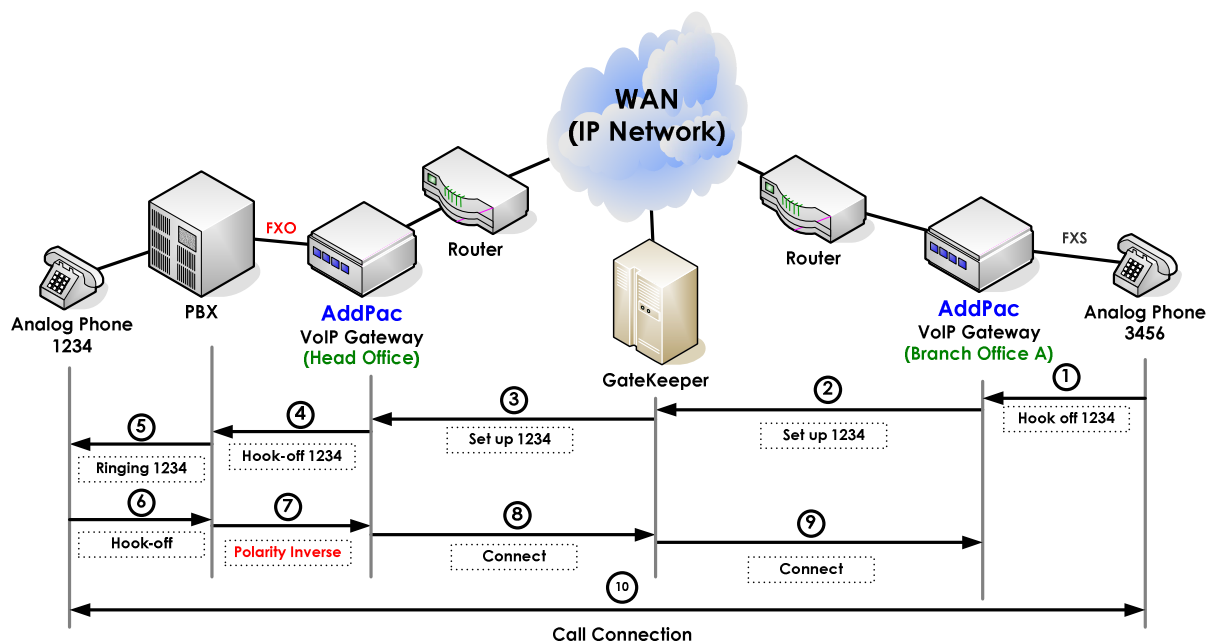

Fig. 6-7 VoIP gateway polarity inverse feature on FXO port

At the above example, PBX requires polarity inversion signal from trunk line to start billing and the inversion signal is sent from the head office. The signal is generated when the called party VoIP gateway receives connect message.

**APOS command script**

```

!
hostname HO
!
interface ether0.0
 ip address 192.168.1.1 255.255.255.0
!
!
voice-port 0/0
! FXO
 polarity-inverse
!
dial-peer voice 0 pots
 destination-pattern 5683847
 port 0/0
!
dial-peer voice 1000 voip
 destination-pattern 5683848
 session target 193.158.1.2
 dtmf-relay h245-alphanumeric
!
voip-interface ether0.0
!
!
    
```

### APOS command script (Configuration Verification)

```

HO# show voice port 0/0
Voice port slot(0)/port(0)
  line type = FXS
  status = Idle
  input gain = 0 db
  output gain = 0 db
  ring frequency = 25 Hz
  ring cadence = 1000 msec on, 2000 msec off
  polarity inverse = enabled
  tie connection = none
  description =
  translate incoming called-number = -1
  translate incoming calling-number = -1
  comfort noise generation = enabled
  dial tone generation = enabled
  echo cancellation = enabled
  announcement = enabled
  low dtmf gain = -8
  high dtmf gain = -5
  caller ID = enabled
  caller ID type = bellcore
  caller ID NAME = enabled
  busyout action = none
  associated call number = -1

```

## Related APOS commands & structure

Configure the below parameters appropriate for the network environment.

None

To configure the application, follow this procedure.

Step	Commands	Description
1	HO(config-ether0.0)# <b>voice-port</b> 0/0	Select the voice port to configure.
2	HO(config-voice-port-0/0)# <b>polarity-inverse</b>	Enable the polarity inverse feature.

# E&M Voice Interface Configuration

This part provides information on general E&M configuration and related commands. For more detailed information, refer to APOS Operation Guide.

**NOTE** For E&M voice interface hardware configuration, refer to Chapter 7. Appendix.

**NOTE** This application is supported by AddPac Technology's all VoIP products along with VoIP Gateway which can be equipped with E&M voice interface modules.

## Network Diagram

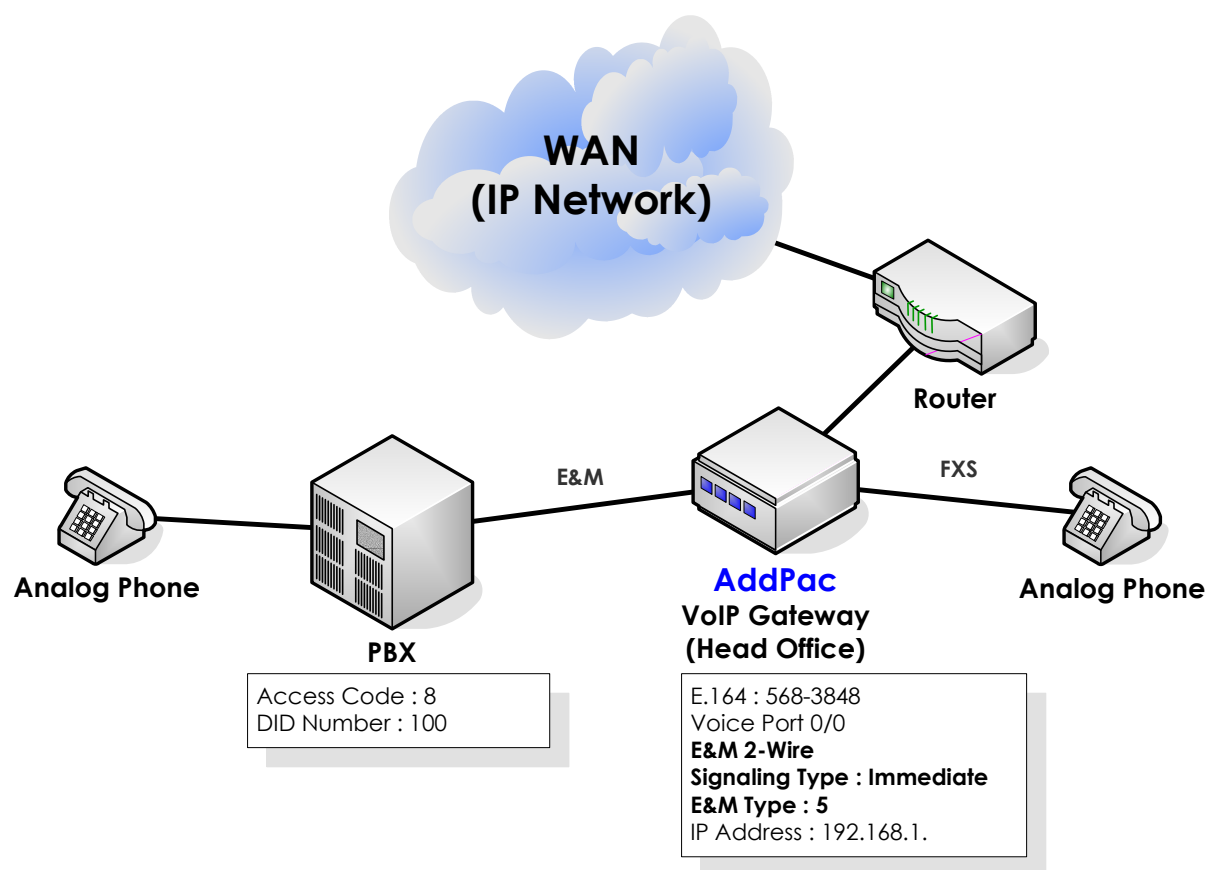

Fig. 6-8 VoIP gateway E&M interface

This part provides information on E&M 2/4-wire configuration



between PBX and VoIP gateway(Head Office). Information for E&M wire type and Dip switch configuration of AddPac's E&M voice interface module, refer to Chapter 7. Appendix.

### APOS command script

```

!
hostname HO
!
interface ether0.0
 ip address 192.168.1.1 255.255.255.0
!
!
voice-port 0/0
! E&M
 operation 2-wire

 signal immediate
 type 5
!
!
dial-peer voice 0 pots
 destination-pattern 5683847
 port 0/0
!
dial-peer voice 1000 voip
 destination-pattern 5683848
 session target 193.158.1.2
 dtmf-relay h245-alphanumeric
!
voip-interface ether0.0
!

```

### APOS command script (Configuration Verification)

```

HO# show voice port 0/0
Voice port slot(0)/port(0)
  line type = E&M
  status = Idle
  input gain = 0 db
  output gain = 0 db
  tie connection = none
  description =
  E&M operation = 2-wire
  E&M signal = immediate
  E&M type = 5
  E&M non-confirmed connect = disabled
  E&M delay duration = 2000 msec
  E&M delay start = 300 msec
  E&M dialout delay = 300 msec
  E&M wait wink = 550 msec
  E&M wink duration = 200 msec
  E&M wink wait = 200 msec
  translate incoming called-number = -1
  translate incoming calling-number = -1
  comfort noise generation = enabled

```

---

```
dial tone generation = enabled
echo cancellation = enabled
announcement = enabled
low dtmf gain = -8
high dtmf gain = -5
busyout action = none
associated call number = -1
```

---

## Related APOS commands & structure

Configure the below parameters appropriate for the network environment.

- E&M Signaling type
- E&M wire type
- E&M type

To configure the application, follow this procedure.

Step	Commands	Description
1	HO(config-ether0.0)# <b>voice-port</b> 0/0	Enter the voice port configuration mode.
2	HO(config-voice-port-0/0)# <b>operation 2-wire</b>	Configure 2-wire E&M voice interface.
3	HO(config-voice-port-0/0)# <b>signal immediate</b>	
4	HO(config-voice-port-0/0)# <b>type 5</b>	

---

---

# Chapter 7. Appendix

---

---

## E&M Voice Interface Dip Switch setting

E&M voice interface is equipped with jumper switches for E&M type selection.

---

**NOTE** E&M voice interface dip switch setting is supported by AddPac Technology's all VoIP products along with VoIP Gateway which can be equipped with E&M voice interface modules.

---

## E&M Voice Interface Module Jumper Switch

Each jumper switch of E&M voice interface module is marked at the below picture. Fourteen (14) jumper switches consist of 7 groups.

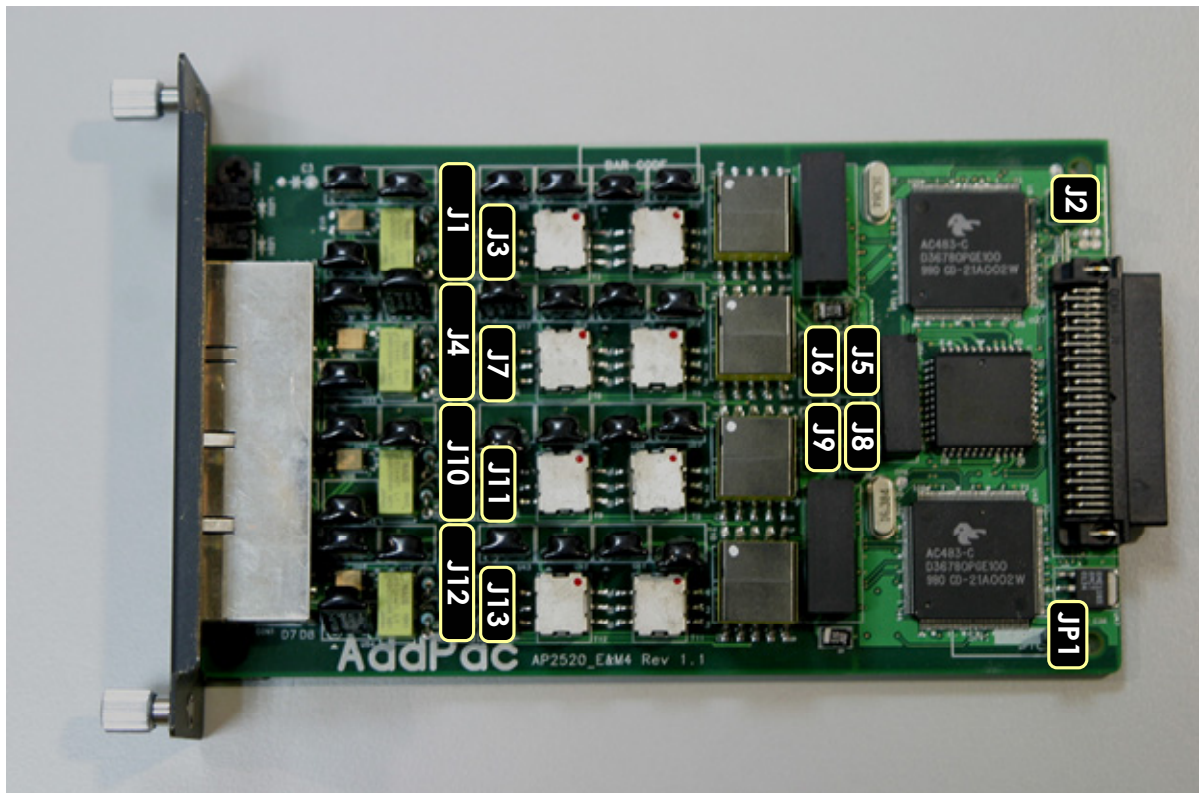

Fig. 7-1 E&M voice interface module jumper switch image

## E&M Voice Interface Jumper Switch Description

E&M voice interface jumper switch group operates with a specific purpose. More detailed descriptions are provided below.

### E&M voice interface groups and purposes

Type	Jumper	Purpose
Wire type	JP1, J3, J5, J6, J7, J8, J9, J11, J13	2/4-wire type jumper switches
Module board ID	J2	E&M voice interface module board ID setting. The setting is fixed at shipment and unable to modify.
E&M type	J1, J4, J10, J12	E&M voice interface type setting. Selectable from 5 types of channels.

### E&M voice interface channels and jumper switches

Channels	Jumper	Description
Channel 0	J1	Supports voice channel line 0 of E&M voice interface module.
Channel 1	J4	Supports voice channel line 1 of E&M voice interface module.
Channel 2	J10	Supports voice channel line 2 of E&M voice interface module.
Channel 3	J12	Supports voice channel line 3 of E&M voice interface module.

E&M channels supported by E&M voice interface jumper switches are provided below.

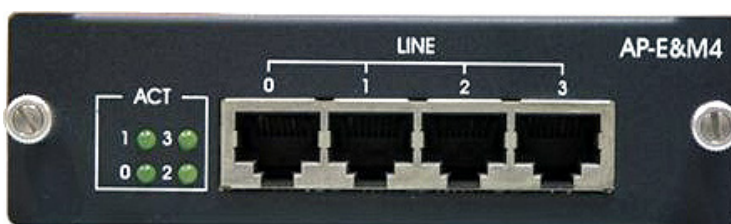

Fig. 7-2 E&M voice interface module front view

# E&M Voice Interface Type and Jumper Setting

## E&M voice interface type and jumper setting

Type	Jumper	Setting	Description																					
Type I	J1, J4, J10, J12	<table border="1"> <tr> <td>B1</td><td>B2</td><td>B3</td><td>B4</td><td>B5</td><td>B6</td><td>B7</td> </tr> <tr> <td></td> <td></td> <td></td> <td></td> <td></td> <td></td> <td></td> </tr> <tr> <td>A1</td><td>A2</td><td>A3</td><td>A4</td><td>A5</td><td>A6</td><td>A7</td> </tr> </table>	B1	B2	B3	B4	B5	B6	B7								A1	A2	A3	A4	A5	A6	A7	Jumper switch setting for E&M voice interface type1. Connect only A3-B3, A5-B5 and leave others open.
B1	B2	B3	B4	B5	B6	B7																		
A1	A2	A3	A4	A5	A6	A7																		
Type II	J1, J4, J10, J12	<table border="1"> <tr> <td>B1</td><td>B2</td><td>B3</td><td>B4</td><td>B5</td><td>B6</td><td>B7</td> </tr> <tr> <td></td> <td></td> <td></td> <td></td> <td></td> <td></td> <td></td> </tr> <tr> <td>A1</td><td>A2</td><td>A3</td><td>A4</td><td>A5</td><td>A6</td><td>A7</td> </tr> </table>	B1	B2	B3	B4	B5	B6	B7								A1	A2	A3	A4	A5	A6	A7	Jumper switch setting for E&M voice interface type2. Connect only A2-B2, A5-B5, A6-B6 and leave others open.
B1	B2	B3	B4	B5	B6	B7																		
A1	A2	A3	A4	A5	A6	A7																		
Type III	J1, J4, J10, J12	<table border="1"> <tr> <td>B1</td><td>B2</td><td>B3</td><td>B4</td><td>B5</td><td>B6</td><td>B7</td> </tr> <tr> <td></td> <td></td> <td></td> <td></td> <td></td> <td></td> <td></td> </tr> <tr> <td>A1</td><td>A2</td><td>A3</td><td>A4</td><td>A5</td><td>A6</td><td>A7</td> </tr> </table>	B1	B2	B3	B4	B5	B6	B7								A1	A2	A3	A4	A5	A6	A7	Jumper switch setting for E&M voice interface type 3. Connect only A1-B1, A3-B3, A5-B5, A6-B6 and leave others open.
B1	B2	B3	B4	B5	B6	B7																		
A1	A2	A3	A4	A5	A6	A7																		
Type IV	J1, J4, J10, J12	<table border="1"> <tr> <td>B1</td><td>B2</td><td>B3</td><td>B4</td><td>B5</td><td>B6</td><td>B7</td> </tr> <tr> <td></td> <td></td> <td></td> <td></td> <td></td> <td></td> <td></td> </tr> <tr> <td>A1</td><td>A2</td><td>A3</td><td>A4</td><td>A5</td><td>A6</td><td>A7</td> </tr> </table>	B1	B2	B3	B4	B5	B6	B7								A1	A2	A3	A4	A5	A6	A7	Jumper switch setting for E&M voice interface type 4. Connect only A1-B1, A2-B2, A3-B3, A4-B4 and leave others open
B1	B2	B3	B4	B5	B6	B7																		
A1	A2	A3	A4	A5	A6	A7																		
Type V	J1, J4, J10, J12	<table border="1"> <tr> <td>B1</td><td>B2</td><td>B3</td><td>B4</td><td>B5</td><td>B6</td><td>B7</td> </tr> <tr> <td></td> <td></td> <td></td> <td></td> <td></td> <td></td> <td></td> </tr> <tr> <td>A1</td><td>A2</td><td>A3</td><td>A4</td><td>A5</td><td>A6</td><td>A7</td> </tr> </table>	B1	B2	B3	B4	B5	B6	B7								A1	A2	A3	A4	A5	A6	A7	Jumper switch setting for E&M voice interface type 5. Connect only A3-B3, A4-B4 and leave others open
B1	B2	B3	B4	B5	B6	B7																		
A1	A2	A3	A4	A5	A6	A7																		

J1, J4, J10, J12 jumper switch points 7 separated (A1~A7, B1~B7) jumper switch groups.

# E&M Voice Interface Wire Type and Jumper Setting

## 2-Wire E&M Voice Interface Jumper Setting

### 2-wire E&M Voice Interface Jumper Setting

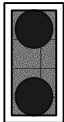
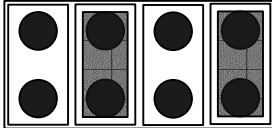
Type	Jumper	Setting	Description
Main jumper	JP1	<b>B1</b>  <b>A1</b>	Main jumper for 2-wire type E&M voice interface setting. Connect A1-B1.
Wire jumper	setting J3, J5, J6, J7 J8, J9, J11, J13	<b>B1 B2 B3 B4</b>  <b>A1 A2 A3 A4</b>	Jumper for 2-wire type E&M voice interface setting. Connect A2-B2, A4-B4. Each jumper switch refers to the 4 difference jumper switch groups.

☞ Wire setting jumper J3/J5 and E&M channel line 0, J6/J7 and E&M channel line 1, J9/J11 and E&M channel line 2, J8/J13 and E&M channel line 3 are separately mapped to each other.

## 4-Wire E&M Voice Interface Jumper Setting

### 4-wire E&M Voice Interface Jumper Setting

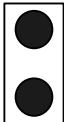
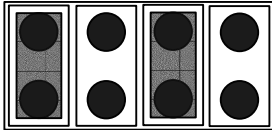
Type	Jumper	Setting	Description
Main jumper	JP1	<b>B1</b>  <b>A1</b>	Main jumper for 4-wire type E&M voice interface setting. Open A1-B1.
Wire jumper	setting J3, J5, J6, J7 J8, J9, J11, J13	<b>B1 B2 B3 B4</b>  <b>A1 A2 A3 A4</b>	Jumper for 4-wire type E&M voice interface setting. Connect A1-B1, A3-B3. Each jumper switch refers to the 4 difference jumper switch groups.

☞ Wire setting jumper J3/J5 and E&M channel line 0, J6/J7 and E&M channel line 1, J9/J11 and E&M channel line 2, J8/J13 and E&M channel line 3 are separately mapped to each other.

## Glossary

Terms	Definition & Description
<b>ADSL</b>	An acronym for Asymmetric Digital Subscriber Line, ADSL is a method of transmitting data over traditional copper telephone lines. Data can be downloaded at speeds of up to 1.544 Megabits per second and uploaded at speeds of 128 Kilobits per second (asymmetric).
<b>AP-VPMS</b>	An acronym for VoIP Plug & Play Management Software. AddPac Technology developed integrated management software for VoIP product remote installation, real-time monitoring, network management on Graphic User Interface (GUI).
<b>API</b>	An acronym for Application Programming Interface, an Interface which is used for accessing an application or a service from a program.
<b>APOS</b>	An acronym for AddPac Internetworking Operation System, AddPac Technology developed operating system for network devices.
<b>ATM</b>	An acronym for Asynchronous Transfer Mode. It an International Cell Relay standard sending various service such as voice, video and data as fixed size (53bytes) cells. With the fixed size cells, the cell processing is mainly done by hardware, so the transmission delay is significantly reduced. ATM is designed for high transmission media such as E3, SONET, T3.
<b>ATM Information Super-highway</b>	Starting from '1993, ATM information Super-highway was established to offer data service and internet service to public offices by the Korean government. Data service includes ATM, Dedicated line, packet switching, Frame relay and Internet service includes Internet compound service and internet service via ATM access lines.
<b>ATM Forum</b>	Establish by Cisco Systems, NET/ADAPTIVE, Northern Telecom, Sprint in '1991 for the development and acceleration of ATM technology standards. It encompasses the standard by ANSI and ITU-T, and further develops the agreed terms of ATM standard.
<b>Authentication</b>	Authentication ensures that digital data transmissions are delivered to the intended receiver. Authentication also assures the receiver of the integrity of the message and its source (where or whom it came from).
<b>BNC Connector</b>	A standard connector connecting IEEE 802.3 10Base-2 coaxial cable to MAU(Media Access Unit).
<b>Boot Loader</b>	The built-in chip on the printed circuit board generating booting command of network equipment.

---

<b>Bps</b>	Bits per second. Refer to: bit rate.
<b>Cable Modem</b>	A modem designed to operate over cable TV lines. Because the coaxial cable used by cable TV provides much greater bandwidth than telephone lines, a cable modem can be used to achieve more bandwidth. Cable network also requires modularization and demutualization process while sending the data.
<b>Call Center</b>	A call center is a central place where customer and other telephone calls are handled by an organization, usually with some amount of computer automation. Typically, a call center has the ability to handle a considerable volume of calls at the same time, to screen calls and forward them to someone qualified to handle them, and to log calls. Call centers are used by mail-order catalog organizations, telemarketing companies, computer product help desks, and any large organization that uses the telephone to sell or service products and services.
<b>Caller ID</b>	A feature that displays the name and/or number of the calling party on the phone's display when an incoming call is received. Virtually all digital phones - as well as many analog phones - have this capability. While typically only the number is received, most phones will display the name, if the number matches an entry in the phone's built-in phone book.
<b>Category 5 cabling</b>	unshielded twisted pair (UTP) cabling. An Ethernet network operating at 10 Mbits/second (10BASE-T) will often tolerate low quality cables, but at 100 Mbits/second (10BASE-Tx) the cable must be rated as Category 5, or Cat 5 or Cat V, by the Electronic Industry Association (EIA).
<b>CBR</b>	Constant Bit Rate. A data transmission that can be represented by a non-varying, or continuous, stream of bits or cell payloads. Applications such as voice circuits generate CBR traffic patterns. CBR is an ATM service type in which the ATM network guarantees to meet the transmitter's bandwidth and Quality of Service requirements
<b>CES</b>	An acronym for Circuit Emulation Service. enables users to multiplex or to concentrate multiple circuit emulation streams for voice and video with packet data on a single, high-speed ATM link without a separate ATM access multiplexer.
<b>Checksum</b>	A computed value which is dependent upon the contents of a packet. This value is sent along with the packet when it is transmitted. The receiving system computes a new checksum based upon the received data and compares this value with the one sent with the packet. If the

---



	two values are the same, the receiver has a high degree of confidence that the data was received correctly.
<b>Coaxial cable</b>	A cable with a single inner conductor with foam insulation and braided shield. There are two types of this cable; 50Ω cable for digital signaling process and 75Ω cable for analog signal process and high speed digital signal process.
<b>CODEC</b>	An acronym for COder-DECoder 1. Built-in circuit device for coding/decoding of analog signal to bit stream with Pulse Code Modulation method. 2. DSP software algorithm for compressing/decompressing voice or audio signal
<b>Console</b>	DTE interface whether the command is delivered to the host.
<b>CoS</b>	Class of Service (CoS) is a way of managing traffic in a network by grouping similar types of traffic (for example, e-mail, streaming video, voice, large document file transfer) together and treating each type as a class with its own level of service priority. Unlike Quality of Service (QoS) traffic management, Class of Service technologies do not guarantee a level of service in terms of bandwidth and delivery time; they offer a "best-effort."
<b>Decryption</b>	The process of converting encrypted data back into its original form, so it can be understood.
<b>DHCP</b>	Dynamic Host Configuration Protocol. A protocol which allows a host to obtain configuration information, such as its IP address and the default router from a server. This simplifies network administration because the software keeps track of IP addresses. With DHCP device can have a different IP address every time it connects to the network
<b>DNS</b>	Domain Name Server, an Internet service that translates domain names into IP addresses.
<b>DS-3</b>	Digital signal level 3, A line capable of delivering 44.7 Mbps (44,700 Kbps) in both directions
<b>DSP</b>	Digital Signal Processor. Dedicated microprocessor for digital signal process.
<b>DTMF</b>	Dual Tone Multi-Frequency. Using two types of voice-band tones for dialing.
<b>E&amp;M</b>	An acronym for receive and transmit or ear and mouth. E&M interface uses a RJ-48 telephone cable to connect remote calls from an IP network to PBX trunk lines (tie lines) for local distribution. It is a signaling technique for two-wire and four-wire telephone and trunk interfaces.
<b>E1</b>	The basic building block for European multi-megabit data rates, with a

---

	bandwidth of 2.048Mbps.
<b>Encryption</b>	the manipulation of a packet's data in order to prevent any but the intended recipient from reading that data.
<b>Ethernet</b>	Broadband LAN standard initiated by Xerox Corporation and co-developed by Intel and DEC. Utilizing CSMA/CD and the various cables of 10Mbps are used. It is similar to IEEE 802.3. Refer to: 10Base-2, 10Base5, 10Base-F, 10Base-T, 10Broad-36, Fast Ethernet, IEEE 802.3.
<b>FAX</b>	Short for "FACSimile." In essence, a fax machine sends an electronic "facsimile" or copy of the document. An optical scanner in the machine scans the document and the resulting bit stream is then sent to the receiving machine via telephone line. The transmission and the reproduction at a distance of still pictures printed matter and similar documented material
<b>Frame</b>	data that is transmitted between network points as a unit complete with addressing and necessary protocol control information. A frame is usually transmitted serial bit by bit and contains a header field and a trailer field that "frame" the data. (Some control frames contain no data.)
<b>Frame-Relay</b>	Switching type Data Link Layer Protocol. Using HDLC capsule, process multi-number of virtual circuits between devices.
<b>FTP</b>	an acronym for File Transfer Protocol, a very common method of transferring one or more files from one computer to another. Defined at RFC 959.
<b>FXO</b>	Foreign Exchange Office. An FXO interface connects to the Public Switched Telephone Network (PSTN) central office and is the interface offered on a standard telephone.
<b>FXS</b>	Foreign Exchange Station. An FXS interface connects directly to a standard telephone and supplies ring, voltage, and dial tone.
<b>G.711</b>	Describes the 64-kbps PCM voice coding technique. In G.711, encoded voice is already in the correct format for digital voice delivery in the PSTN or through PBXs.
<b>G.723.1</b>	Describes a compression technique that can be used for compressing speech or audio signal components at a very low bit rate as part of the H.324 family of standards. This CODEC has two bit rates associated with it: 5.3 and 6.3 kbps. The higher bit rate is based on ML-MLQ technology and provides a somewhat higher quality of sound. The lower bit rate is based on CELP and provides system designers with additional flexibility.
<b>G.726</b>	Describes ADPCM coding at 40, 32, 24 and 16 kbps. ADPCM encoded

---

	voice can be interchanged between packet voice, PSTN, and PBX networks if the PBX networks are configured to support ADPCM. Described in the ITU-T standard in its G-series recommendations.
<b>G.728</b>	Describes a 16 kbps low-delay variation of CELP voice compression. CELP voice coding must be translated into a public telephony format for delivery to or through the PSTN. Described in the ITU-T standard in its G-series recommendations..
<b>Gatekeeper</b>	The component of an H.323 conferencing system that performs call address resolution, admission control, and subnet bandwidth management. H.323 entity on a LAN that provides address translation and control access to the LAN for H.323 terminals and gateways. The gatekeeper can provide other services to the H.323 terminals and gateways, such as bandwidth management and locating gateways. A gatekeeper maintains a registry of devices in the multimedia network. The devices register with the gatekeeper at startup and request admission to a call from the gatekeeper.
<b>H.225</b>	An International Telecommunication Union (ITU-T) standard for H.225.0 session control and packetization. It defines various protocols of RAS, Q.931, RTP and etc.
<b>H.245</b>	An International Telecommunication Union (ITU-T) standard for H.245 end-point control.
<b>H.323</b>	An International Telecommunication Union (ITU-T) standard that describes packet-based video, audio, and data conferencing.
<b>HBD3</b>	Line code type of E1 line.
<b>HDLC</b>	An acronym for High-Level Data Link Control. A transmission protocol for the Data Link Layer. In HDLC, data is organized into a unit (called a frame) and sent across a network to a destination that verifies its successful arrival. Variations of HDLC are also used for the public networks that use the X.25 communications protocol and for frame relay, a protocol used in both and wide area network, public and private.
<b>Hookflash</b>	Short on-hook period usually generated by a telephone-like device during a call to indicate that the telephone is attempting to perform a dial-tone recall from a PBX. Hookflash is often used to perform call transfer.
<b>HTTP</b>	An acronym for Hypertext Transfer Protocol. A file transfer protocol used by web browser or web server for transmitting text or graphic files.
<b>IPSec</b>	Internet Protocol Security protocol, a framework for a set of protocols

---

for security at the network or packet processing layer of network communication. Earlier security approaches have inserted security at the Application layer of the communications model. IPsec is said to be especially useful for implementing virtual private networks and for remote user access through dial-up connection to private networks. A big advantage of IPsec is that security arrangements can be handled without requiring changes to individual user computers. Cisco has been a leader in proposing IPsec as a standard (or combination of standards and technologies) and has included support for it in its network routers.

---

**IPv6**

IPv6 (Internet Protocol Version 6) is the latest level of the Internet Protocol (IP) and is now included as part of IP support in many products including the major computer operating systems. IPv6 has also been called "IPng" (IP Next Generation). Formally, IPv6 is a set of specifications from the Internet Engineering Task Force (IETF). IPv6 was designed as an evolutionary set of improvements to the current IP Version 4. Network hosts and intermediate nodes with either IPv4 or IPv6 can handle packets formatted for either level of the Internet Protocol. Users and service providers can update to IPv6 independently without having to coordinate with each other.

---

**ISP**

An ISP (Internet service provider) is a company that provides individuals and other companies access to the Internet and other related services such as Web site building and virtual hosting. An ISP has the equipment and the telecommunication line access required to have a point-of-presence on the Internet for the geographic area served. The larger ISPs have their own high-speed leased lines so that they are less dependent on the telecommunication providers and can provide better service to their customers. Among the largest national and regional ISPs are AT&T WorldNet, IBM Global Network, MCI, Netcom, UUNet, and PSINet.

---

**ITU-T**

The ITU-T (for Telecommunication Standardization Sector of the International Telecommunications Union) is the primary international body for fostering cooperative standards for telecommunications equipment and systems. It was formerly known as the CCITT. It is located in Geneva, Switzerland

---

**IVR**

Interactive Voice Response (IVR) is a software application that accepts a combination of voice telephone input and touch-tone keypad selection and provides appropriate responses in the form of voice, fax, callback, e-mail and perhaps other media. IVR is usually part of a larger

---

---

	application that includes database access. Common IVR applications include: Bank and stock account balances and transfers.
<b>LAN</b>	A local area network is a group of computers and associated devices that share a common communications line and typically share the resources of a single processor or server within a small geographic area (for example, within an office building). LAN standard defines cable connection and signal processing on Physical Layer and Data Link Layer.
<b>Link</b>	Network communication channels consisting of sending and receiving devices, circuits, transmission path. Usually refer to WAN connection. Referred as Line, or transmission link.
Loopback test	A loopback test is a test in which a signal is sent from a communications device and returned (looped back) to it as a way to determine whether the device is working right or as a way to pin down a failing node in a network.
<b>MAC Address</b>	Standardized data link layer address that is required for every port or device that connects to a LAN. Other devices in the network use these addresses to locate specific ports in the network and to create and update routing tables and data structures. MAC addresses are 6 bytes long and are controlled by the IEEE. Also known as a hardware address, MAC-layer address, and physical address. Compare with network address.
<b>MAN</b>	A data network designed for a town or city. MANs are considered larger than LANs but smaller than WANs. Compare with: LAN, WAN.
<b>MGCP</b>	MGCP, also known as H.248 and Megaco, is a standard protocol for handling the signaling and session management needed during a multimedia conference. The protocol defines a means of communication between a media gateway, which converts data from the format required for a circuit-switched network to that required for a packet-switched network and the media gateway controller. MGCP can be used to set up, maintain, and terminate calls between multiple endpoints. Megaco and H.248 refer to an enhanced version of MGCP
<b>NAT</b>	NAT (Network Address Translation) is the translation of an Internet Protocol address (IP address) used within one network to a different IP address known within another network. One network is designated the inside network and the other is the outside.
<b>NTP</b>	Network Time Protocol (NTP) is a protocol that is used to synchronize computer clock times in a network of computers. In common with

---

	similar protocols, NTP uses Coordinated Universal Time (UTC) to synchronize computer clock times to a millisecond, and sometimes to a fraction of a millisecond.
<b>PABX</b>	Private Automatic Branch Exchange. A telephone switch for use inside a corporation. It connects offices (internal extensions) with each other and provides access (typically by dialing an access number such as 9) to the public telephone network PABX is the preferred term in Europe, PBX is used in the USA.
<b>Packet</b>	Packets contain a source and destination address as well as the actual message. Packets also known as Datagrams.
<b>PBX</b>	A PBX (private branch exchange) is a telephone system within an enterprise that switches calls between enterprise users on local lines while allowing all users to share a certain number of external phone lines.
<b>PING</b>	Packet INternet Groper, a packet (small message) sent to test the validity / availability of an IP address on a network
<b>Point to Point Connection</b>	Basic connection type. In ATM, point to point connection is half duplex connection between two ATM end systems or full duplex connection.
<b>Pont to Multipoint Connection</b>	Basic connection type. In ATM, point to multipoint connection is half duplex connection among one sending end system (root node) and multiple receiving end system. Compare with: point-to-point connection.
<b>POTS</b>	Plain Old Telephone Service. Compare with: PSTN.
<b>PPP</b>	The most popular method for transporting IP packets over a serial link between the user and the ISP. Developed in 1994 by the IETF and superseding the SLIP protocol, PPP establishes the session between the user's computer and the ISP using its own Link Control Protocol (LCP). PPP supports PAP, CHAP and other authentication protocols as well as compression and encryption.
<b>Protocol Stack</b>	Any set of communication protocols, such as TCP/IP, that consists of two or more layers of software and hardware. It's called a stack because each layer builds on the functionality in the layer below
<b>PSTN</b>	Public Switched Telephone Network – term for the entire, world-wide telephone network. Sometimes refers to as POTS.
<b>PVC</b>	Permanent Virtual Circuit or permanent virtual connection. A continuously available communications path that connects two fixed end points.

<b>Q.931 Signaling</b>	ITU-T specification for network layer of ISDN. Q.931 uses out-of-band signaling on the D-channel to control calls.
<b>QoS</b>	This refers to the assumption that data transmission rates, error rates, and other characteristics can be measured, improved, and to some degree, guaranteed in advance. Basically, QoS describes a collective measure of the level of service a provider delivers to its customers or subscribers.
<b>RAM</b>	Random-Access Memory, a non-retentive memory, whose contents get lost after a switch-off or reset. Application programs run in the random access memory and data is stored and processed.
<b>RAS</b>	Registration Admission Status protocol. The communication protocol used to convey registration, admission and status messages between H.323 endpoints and the gatekeeper.
<b>RISC</b>	Reduced Instruction Set Computing
<b>Router</b>	On the Internet, a router is a device or, in some cases, software in a computer, that determines the next network point to which a packet should be forwarded toward its destination. The router is connected to at least two networks and decides which way to send each information packet based on its current understanding of the state of the networks it is connected to. A router is located at any gateway (where one network meets another), including each Internet point-of-presence. A router is often included as part of a network switch. Compare with: gateway. Refer to: relay.
<b>RS-232</b>	Most common Physical Layer interface. Known as EIA/TIA-232.
<b>RTCP</b>	Real-time Control Protocol (RTCP) is a companion protocol of RTP that is used to maintain quality of service. Refer to: RTP(Real-Time Transport Protocol).
<b>RTP</b>	<ol style="list-style-type: none"> <li>1. Routing Table Protocol, VINES routing protocol based on RIP. Distributes network topology, and aids VINES servers in finding neighboring clients, servers, and routers. Uses delay as a routing metric. Refer to: SRTP.</li> <li>2. Rapid Transport Protocol. Provides pacing and error recovery for APPN data as it crosses the APPN network. With RTP, error recovery and flow control are done end-to-end rather than at every node. RTP prevents congestion rather than reacts to it.</li> <li>3. Real-Time Transport Protocol. Commonly used with IP networks. RTP is designed to provide end-to-end network transport functions for applications transmitting real-time data, such as audio, video, or</li> </ol>

	simulation data, over multicast or unicast network services. RTP provides such services as payload type identification, sequence numbering, time-stamping, and delivery monitoring to real-time applications.
<b>SIP</b>	<p>The Session Initiation Protocol (SIP) is an Internet Engineering Task Force (IETF) standard protocol for initiating an interactive user session that involves multimedia elements such as video, voice, chat, gaming, and virtual reality.</p> <p>Like HTTP or SMTP, SIP works in the Application layer of the Open Systems Interconnection (OSI) communications model. The Application layer is the level responsible for ensuring that communication is possible. SIP can establish multimedia sessions or Internet telephony calls, and modify, or terminate them. The protocol can also invite participants to unicast or multicast sessions that do not necessarily involve the initiator. Because the SIP supports name mapping and redirection services, it makes it possible for users to initiate and receive communications and services from any location, and for networks to identify the users whatever they are. SIP is a request-response protocol, dealing with requests from clients and responses from servers. Participants are identified by SIP URLs. Requests can be sent through any transport protocol, such as UDP, SCTP, or TCP. SIP determines the end system to be used for the session, the communication media and media parameters, and the called party's desire to engage in the communication. Once these are assured, SIP establishes call parameters at either end of the communication, and handles call transfer and termination. The Session Initiation Protocol is specified in IETF Request for Comments [RFC] 2543.</p>
<b>SmartViewer</b>	The real-time monitoring, statistical data search and management GUI based software developed by AddPac Technology for AP-GK1000, AP-GK2000, AP-GK3000 models.
<b>SNMP</b>	Simple Network Management Protocol. Network management protocol used almost exclusively in TCP/IP networks. SNMP provides a means to monitor and control network devices, and to manage configurations, statistics collection, performance, and security. Refer to: SGMP, SNMP2.
<b>T1</b>	A TDM physical transmission standard consisting of two twisted wire pairs and related equipment capable of carrying a 1.544 Mbps DS-1 signal. Term often used interchangeably with DS-1. Refer to: AMI, B8ZS, DS-1.
<b>TCP/IP</b>	Transmission Control Protocol/Internet Protocol, The protocol suit



---

	developed by DoD (USA) in 1970s for the worldwide inter-network development. TCP & IP is the most well known protocols of the suite. Refer to: IP, TCAP.
<b>Telco</b>	Telephone Company, referring to the company offering telephone service to customers. Typically, it refers to an individual company such as Bell operating company offering local telephone service, however, sometimes local telephony service providers are included.
<b>Telnet</b>	Standard Terminal Emulation program covered by TCP/IP protocol stack. Used for remote terminal connection. Via Telnet, users can log-in to the system and operate the resources as working on the local system. Defined on RFC 854.
<b>VCI</b>	the address or label of a VC; a value stored in a field in the ATM cell header that identifies an individual virtual channel to which the cell belongs. VCI values may be different for each data link hop of an ATM virtual connection.
<b>VDSL</b>	New DSL technology that accepts bandwidths of up to 27 Mbps over relatively short distances. VDSL, in the process of being standardized, allows symmetric or asymmetric throughputs that are much higher than other xDSL standards (up to 27 Mbps when downloading and 3 Mbps when uploading under asymmetric or 14 Mbps in symmetric), as well as the simultaneous transport of ISDN (Numeris) services but with much shorter ranges that do not exceed 900 m to 1 km. In practice, this technique may require the deployment of optical remotes and the setting up of active equipment in the local loop. Compare with: ADSL, HDSL, SDSL.
<b>VoATM</b>	Voice Over ATM. Voice over ATM enables an ATM switch to carry voice traffic (for example, telephone calls and faxes) over an ATM network. When sending voice traffic over ATM, the voice traffic is encapsulated using AAL1/AAL2 ATM packets.
<b>VoFR</b>	Voice Over Frame Relay. Voice over Frame Relay enables a router to carry voice traffic (for example, telephone calls and faxes) over a Frame Relay network. When sending voice traffic over Frame Relay, the voice traffic is segmented and encapsulated for transit across the Frame Relay network using FRF.12 encapsulation.
<b>VoHDLC</b>	Voice Over HDLC. Voice over HDLC enables a router to carry live voice traffic (for example, telephone calls and faxes) back-to-back to a second router over a serial line.
<b>VoIP</b>	VoIP (Voice delivered using the Internet Protocol) is a term used in IP

---

---

telephony for a set of facilities for managing the delivery of voice information using the Internet Protocol (IP). In general, this means sending voice information in digital form in discrete packets rather than in the traditional circuit-committed protocols of the public switched telephone network (PSTN). A major advantage of VoIP and Internet telephony is that it avoids the tolls charged by ordinary telephone service.

---

**VPN**

Virtual Private Network, VPN allows IP traffic to travel securely over a public TCP/IP network by encrypting all traffic from one network to another. A VPN uses "tunneling" to encrypt all information at the IP level.

---

**WAN**

A network that covers a large geographical area. Typical WAN technologies include point-to-point, X.25 and frame relay. Compare with: LAN, MAN.

---