

Technical Description

■ Overview

Proximity sensor is the non contact detector (sensor) which detects the sensing target when it comes close, not same as the micro switch or the limit switch using the mechanical contact sensing method.

■ Principle and Feature

◎ Inductive proximity sensor

● Principle

When the object (metallic) approaches the high-frequency magnetic field which is produced at the detection coil, induced currents flow in the metal, causing thermal loss and resulting in the reduction or stopping of oscillations. This change in state is detected by an oscillation state sensing circuit which then operates the output circuit.

● Principles of operation

When the proximity sensor is on, the oscillation of the current within 60ms will be increased to certain frequency, and electric field is formed. After that, if the object approaches, the induced current surrounding the sensing object will be increased, and the oscillation of the current will be decreased. When the object is detected completely, the current will be close to 0V. This very little oscillation of the current will be amplified, and will operate the output section.

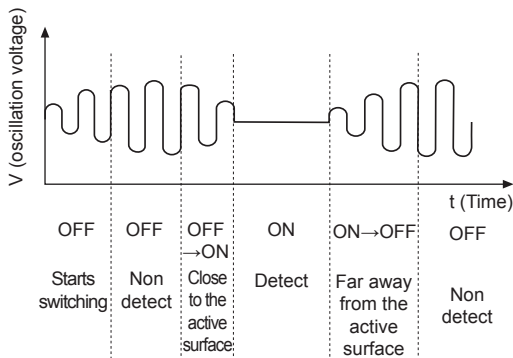

● Configuration

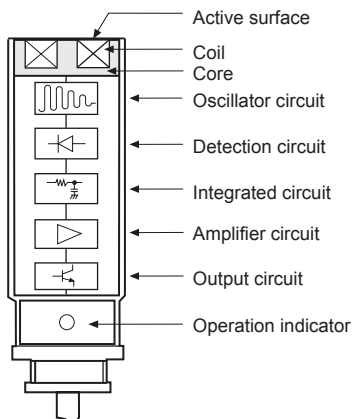

◎ Capacitive proximity sensor

● Principle

As shown below figure, when + current is applied on the pole plate, + charge will be on the pole plate, - charge will be on the ground, and the electric field will be occurred between the pole plate and the ground. When the object approaches to the pole plate, the charges in the object move by the electrostatic induction. - charge will move to the pole plate side, and + charge will move to the other side. This state is called polarization. The object is detected by the strength of the polarization which is strong when the object moves to the pole plate side, and is weak when the object moves far away from the pole plate.

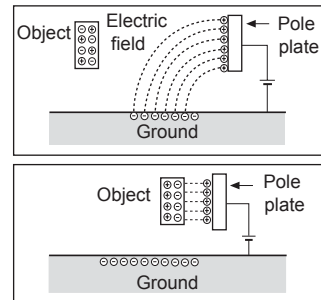

● Principle of operation

Capacitive proximity sensor works contrary method to the inductive proximity sensor. When the sensor power is on, the oscillation of the current is close to 0V. When the object approaches to the sensor, the capacitance will be increased and the oscillation of the current is increased. This output section will be operated by increasing the oscillation.

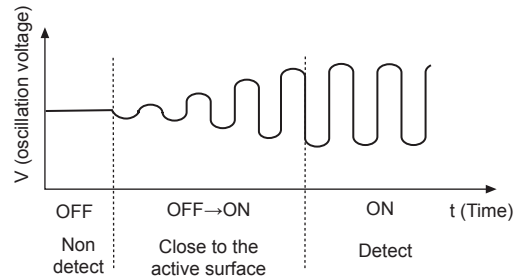

● Configuration

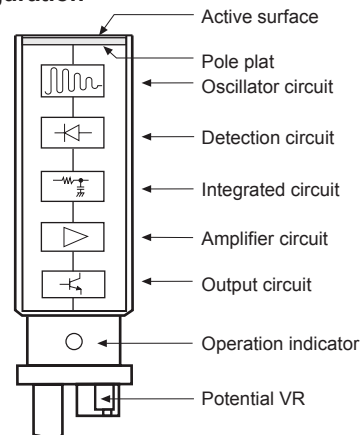

■ Glossary

◎ Standard sensing target

It is the standard of shape, size, and material for each model to measure the standard performance.

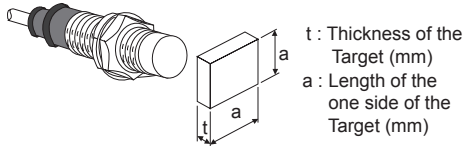

◎ Sensing distance (Sn)

It is the distance between the active surface and the surface of the sensing target, when the output works by approaching the sensing target to the active surface. The specification of sensing distance (Sn) for each series is measured by standard sensing target.

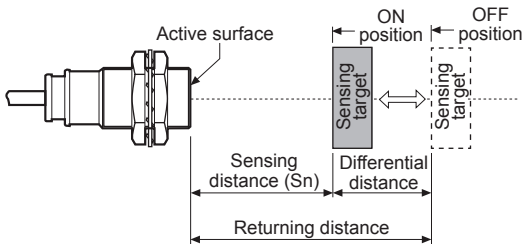

◎ Differential distance (Hysteresis)

The hysteresis is the difference between the operation distance, when the sensor first operates with the standard sensing target approaching from the active surface direction, and the returning distance, when the sensor first stops operating with the standard sensing target receding. This hysteresis prevents chattering of the output due to vibration, etc., of the sensing target.

◎ Setting distance

It is the sensing range for which the sensor can stably detect the standard sensing target even if there is an ambient temperature drift and/or supply voltage fluctuation. Normally, it is 70% of the maximum operation distance.

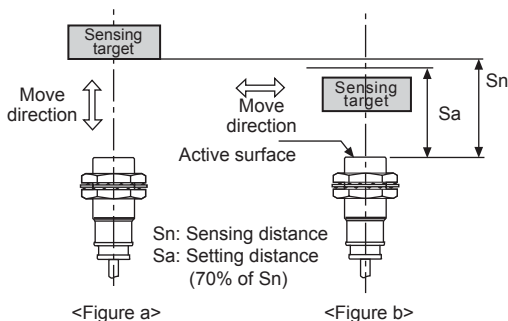

- After verifying the sensing distance like <Figure a>, please move the target within the stable sensing range like <Figure b>.

◎ Response frequency

The number of times per second at which sensing can be done without malfunction, when approach the standard sensing target to the sensor. It shows Hz.

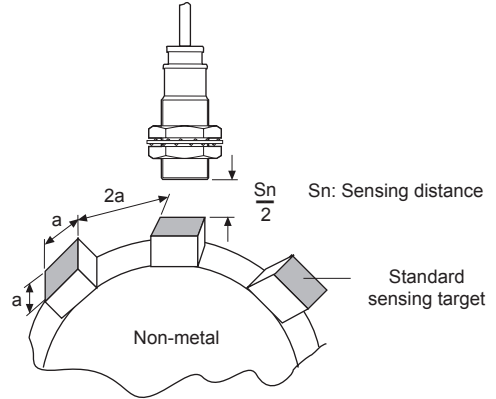

< Response frequency measurement method >

$$\text{Response frequency (f)} = \frac{1}{T} \quad [\text{Hz}]$$

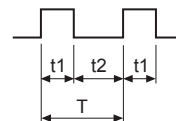

◎ Relative dielectric constant

It is the ratio of between the dielectric constant of the material (ϵ) and the dielectric constant of vacuum (ϵ_0).

$$\epsilon_s = \frac{\epsilon}{\epsilon_0}$$

As the relative dielectric constant is big, the sensing distance is long. And each material has its own value of the relative dielectric constant. The value of the relative dielectric constant for solid is bigger than liquid. There are the relative dielectric constants for typical materials.

Air	1	Polystyrene	1.2
Paper	2.3	PVC	3
Wood	6 to 8	Glass	5
Alcohol	25.8	Water	80

◎ Capacitance

It is the amount of the accumulated charge (Q), when apply voltage at the insulated conductors. As the accumulated charge (Q) is big, the sensing distance becomes long.

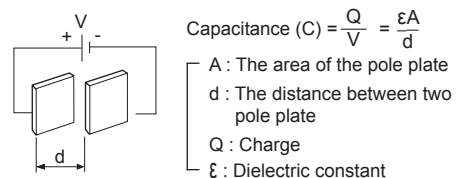

As shown above formula, the capacitance (C) will be increased as the amount of charge (Q) is increased. There are the methods to increase the capacitance, increase the area of the pole plate, use the material that the relative dielectric constant is big or narrow the distance between two pole plates.

(A) Photoelectric Sensors

(B) Fiber Optic Sensors

(C) Door/Area Sensors

(D) Proximity Sensors

(E) Pressure Sensors

(F) Rotary Encoders

(G) Connectors/ Connector Cables/ Sensor Distribution Boxes/Sockets

(H) Temperature Controllers

(I) SSRs / Power Controllers

(J) Counters

(K) Timers

(L) Panel Meters

(M) Tacho / Speed / Pulse Meters

(N) Display Units

(O) Sensor Controllers

(P) Switching Mode Power Supplies

(Q) Stepper Motors & Drivers & Controllers

(R) Graphic/ Logic Panels

(S) Field Network Devices

(T) Software

Technical Description

Mount Sensor

Flush type mounting (shield type)

The most area of the proximity sensor is surrounded by metal except the active surface to prevent the effect of the approaching metal from side. Even though the sensing distance is shorter than non-flush type, the active surface of the sensor can be mounted at the same level of the metal enclosure like below figure.

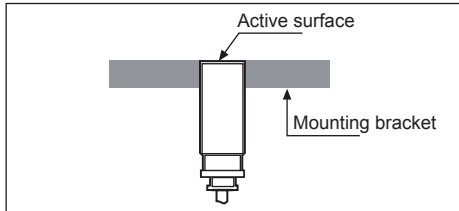

Non-flush type mounting (non-shield type)

The sensor is affected easily by approaching metal from side because the side of the active surface was not shield by metal. The sensing distance is longer than the flush type, but when mount the sensor, please mount on the concave side, and keep the distance three times longer than the diameter of the sensor like below figure.

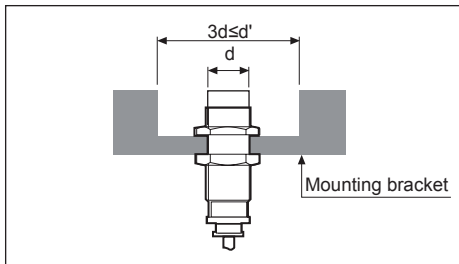

Parallel mounting

When several proximity sensors are mounted close together, there is the effect of mutual interference. Therefore please keep the distance which is two times longer than the diameter of the sensor for flush type, and three times longer than the diameter of the sensor for the non-flush type.

(Non-flush type)

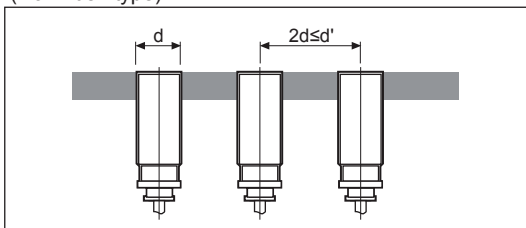

(Flush type)

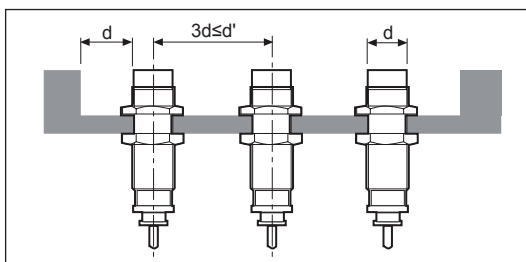

Face to face mounting

When proximity sensors are mounted in face to face, malfunction of sensor may be caused due to mutual interference. Therefore, please keep the distance which is six times longer than the sensing distance.

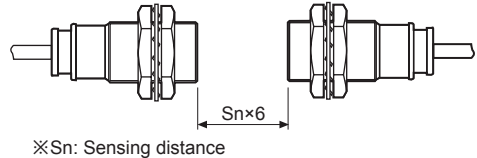

Tightly mounting

When proximity sensors are mounted tightly, malfunction of sensor may be caused due to mutual interference. Therefore, please use differential frequency for the application like below picture. Differential frequency type is only for PSN17 series.

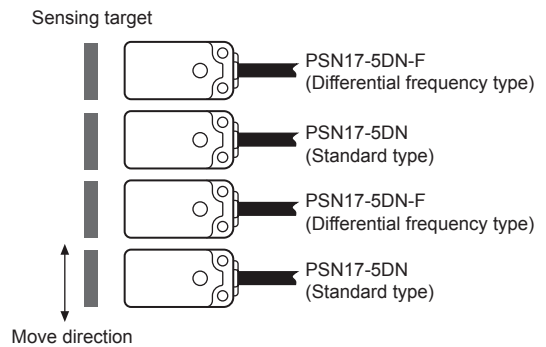

Connection for DC Type

DC 2-wire type

Load connection

If DC 2-wire type is connected without load, the inner device of DC 2-wire type can get damage. Please connect the load before apply power. The load can be connected any power line.

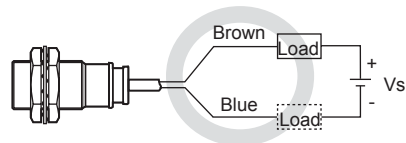
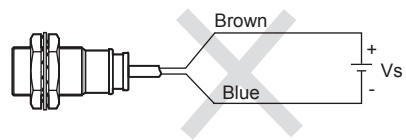

Technical Description

● To connect DC 2-wire type sensor with PLC (Programmable Logic Controller)

DC 2-wire type of proximity sensor can be connected with PLC when input specification of PLC and proximity sensor specification comply with the conditions shown below.

- 1) When ON voltage of PLC and residual voltage of sensor meet following formula.
 $V_{on} \leq V_S - V_R$
- 2) When OFF voltage of PLC and a leakage current of sensor meet following formula.
 $I_{off} \geq I_L$
- 3) When ON current of PLC and control output current of sensor meet following formula.
 $I_{out (min)} \leq I_{on}$

[Note]

- V_{on} : ON voltage of PLC
- V_S : Source voltage
- V_R : Residual voltage of proximity sensor
- I_{off} : OFF current of PLC
- I_L : A leakage current of proximity sensor
- $I_{out (min)}$: The min. value of proximity sensor's control output
- I_{on} : ON current of PLC

- E.g.) PLC input specification - ON voltage: over 15VDC
 ON current: over 4.3mA
 OFF current: under 1.5mA
 Proximity sensor - PRT18-5DO, source voltage is 24VDC
- 1) $V_{on} (15V) \leq V_S (24V) - V_R (3.5V) = 20.5V$: OK
 - 2) $I_{off} (1.5mA) \geq I_L (0.6mA)$: OK
 - 3) $I_{out (min)} (2mA) \leq I_{on} (4.3mA)$: OK

● Connect DC 2-wire type sensor with PLC (Programmable Logic Controller)

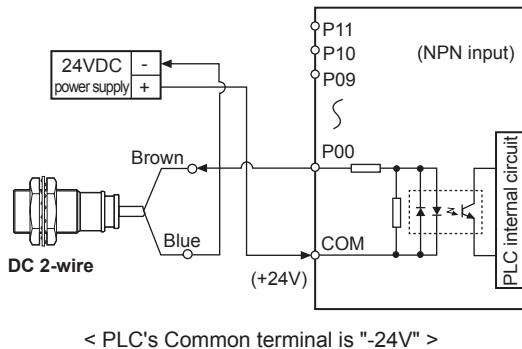
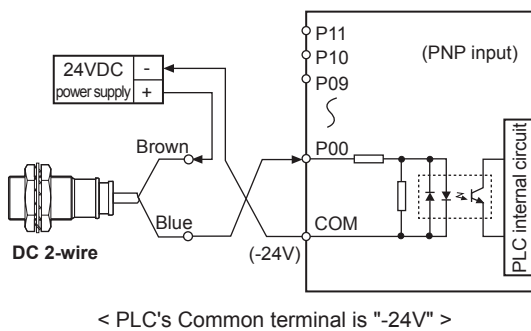

● AND (series) connection

When it is connected in series, all proximity sensors have to be in working to make loads operated. The residual voltage which is related with the number of the sensor should not influence both operating voltage of proximity sensors and driving voltage of a load, and which condition should be considered to choose how many sensors to be connected in series.

To connect sensors in series, choose the number of proximity sensors within the amount that meets formula below.

$$V_S - (n \times V_R) \geq \text{Operating voltage of load.}$$

$$\left[\begin{array}{l} V_S : \text{Source voltage} \quad V_R : \text{Residual voltage} \\ n : \text{The number of connected sensors} \end{array} \right]$$

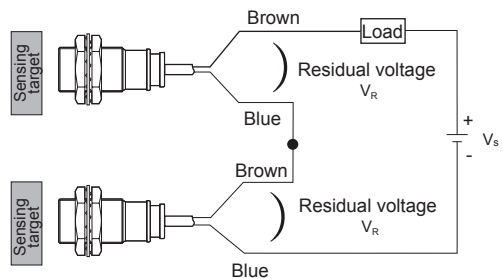

● OR (parallel) connection

When it is connected in parallel, it works even only one sensor is on operation. A little current flows as a leakage current because proximity sensor operates internal circuit even when it is OFF. Because a number of sensors connected in parallel increase the amount of leakage current, load could run when proximity sensor is in OFF status.

Thus, the leakage current which is related with the number of the sensor should not influence the returning current of load, and which condition should be considered to choose how many sensors to be connected in parallel.

To connect several sensors in parallel, choose the number of proximity sensors within the amount that meets the formula below.

$$n \times I_L \leq \text{The returning current of load}$$

$$\left[\begin{array}{l} n : \text{The number of connected sensors} \\ I_L : \text{The leakage current of sensor} \end{array} \right]$$

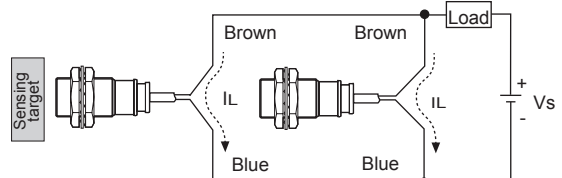

E.g.) When load is relay (24VDC), and connecting PRT18-5DO in parallel,

- The returning current of load : Max. 3.7mA
 - The leakage current of PRT18-5DO : Max. 0.6mA
- Six sensors can be connected in parallel in Max.

(A)	Photoelectric Sensors
(B)	Fiber Optic Sensors
(C)	Door/Area Sensors
(D)	Proximity Sensors
(E)	Pressure Sensors
(F)	Rotary Encoders
(G)	Connectors/ Connector Cables/ Sensor Distribution Boxes/Sockets
(H)	Temperature Controllers
(I)	SSRs / Power Controllers
(J)	Counters
(K)	Timers
(L)	Panel Meters
(M)	Tacho / Speed / Pulse Meters
(N)	Display Units
(O)	Sensor Controllers
(P)	Switching Mode Power Supplies
(Q)	Stepper Motors & Drivers & Controllers
(R)	Graphic/ Logic Panels
(S)	Field Network Devices
(T)	Software

Technical Description

◎ DC 3-wire type

● Load connection

In DC 3-wire type of proximity sensor, there are two types of output, NPN and PNP, and they can either open or close power relay, solenoid, electric counter, PLC, etc.

※In case of using inductive load (relay, motor, magnet, etc.), connect surge absorber diode in parallel with load. Use diode, of which withstand voltage is threefold over power supply.)

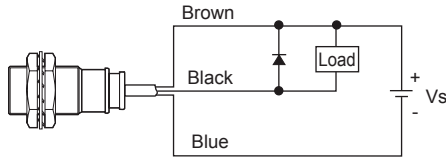

(A circuit using NPN type sensor)

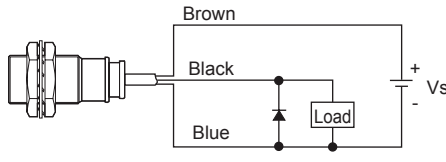

(A circuit using PNP type sensor)

● Connection with PLC (Programmable Logic Controller)

When connecting DC 3-wire type of proximity sensor with PLC, applicable sensor is chosen differently depend on common terminal status.

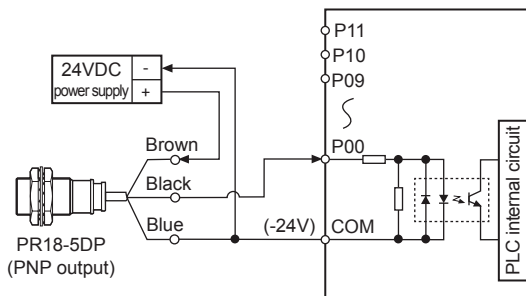

< PLC's Common terminal is "-24V" >

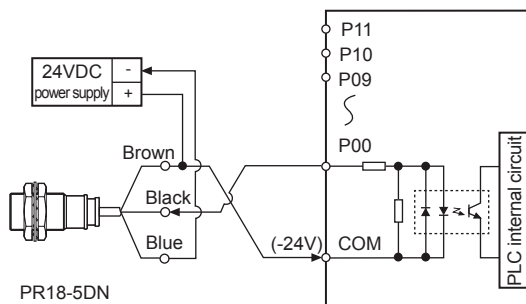

< PLC's Common terminal is "+24V" >

● AND (series) connection

When it is connected in series, all proximity sensors have to be in working to make loads operated. The residual voltage which is related with the number of the sensor should not influence both operating voltage of proximity sensors and driving voltage of a load, and which condition should be considered to choose how many sensors to be connected in series. PNP output type sensor and NPN output type sensor cannot be used in a same circuit.

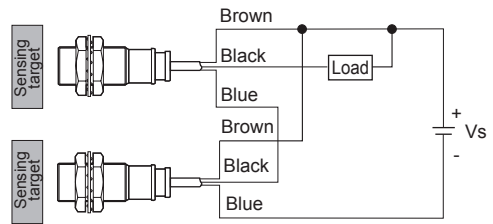

(Series connection of NPN output type sensors)

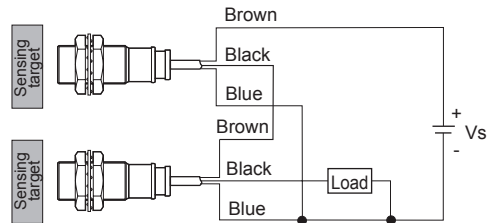

(Series connection of PNP output type sensors)

● OR (parallel) connection

When it is connected in parallel, it works even one sensor is on operation.

The leakage current which is related with the number of the sensor should not influence the returning current of load, and which condition should be considered to choose how many sensors to be connected in parallel. PNP output type sensor and NPN output type sensor cannot be used in a same circuit.

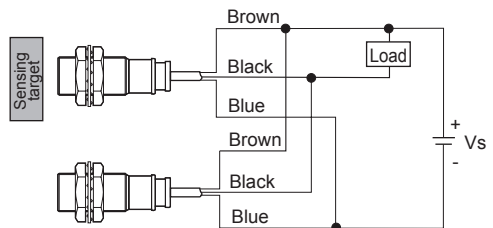

(Parallel connection of NPN output type sensors)

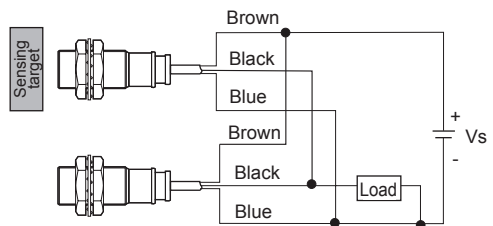

(Parallel connection of PNP output type sensors)

■ Connection for AC Type

◎ Load connection

When using AC 2-wire type sensor, load have to be wired in circuit, otherwise internal element gets burn when power is supplied. Load could be connected any side of power wire.

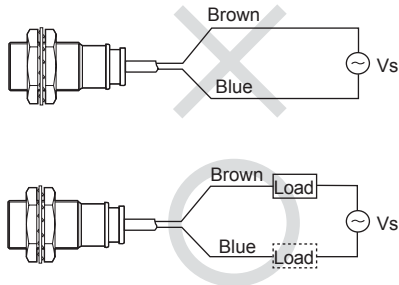

● When operating current of load is not enough

When operating current of load is under 5mA, use bleeder resistance so that current flowing through load can be increased to over 5mA.

Use the formula below to calculate the value of bleeder resistance and allowable current.

$$R \leq \frac{V_s}{I} (\Omega) \quad P > \frac{V_s^2}{R} (W)$$

* I : Operating current of load
P: Allowable voltage

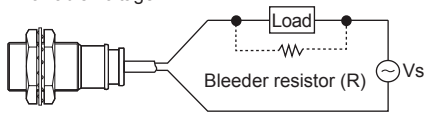

Use load of over 20kΩ 3W for 110VAC power, over 39kΩ 10W for 220VAC.

※When having thermogenic problem, use load that has larger value of watt.

◎ AND (series) connection

In principle AC type of proximity sensor cannot be used in series connection. To use it in series connection, put relay or bleeder resistance in circuit.

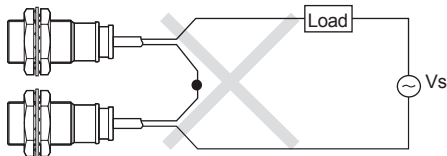

(Figure 1) The wrong way of series connection

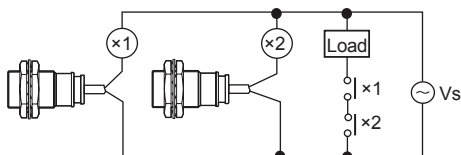

(Figure 2) The right way of series connection

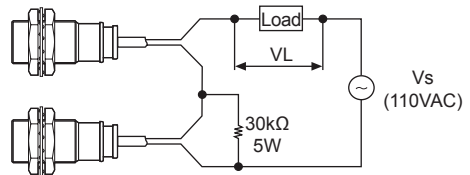

(Figure 3) Bleeder resistance connection method

※Bleeder resistance is not needed when power voltage is 220VAC.

● Load power voltage check

When connecting in series, operating voltage, V_L , is calculated as subtraction of power source voltage and residual voltage of proximity sensor. Thus, it would follow a formula ; $V_L = \text{power source voltage} - (\text{residual voltage of proximity sensor} \times \text{the number of sensor})$

E.g.) $V_s = 110\text{VAC}$, operating voltage of load
 $V_L = 110 - (10 \times 2) = 90\text{V}$, so load that works with 90VAC must be used.

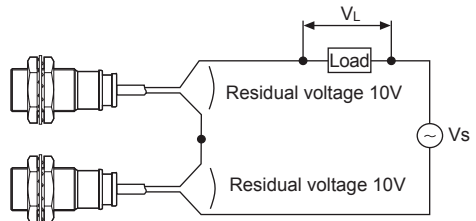

◎ OR (parallel) connection

More than two sensors cannot be connected in a same circuit to operate load. Even though parallel connection is possible when those sensors are not being operated at a same time, because leaking current is increased by n times, returning faulty of load can occur. (n: the number of connected sensors)

Thus, connect relay in parallel so that load can work properly.

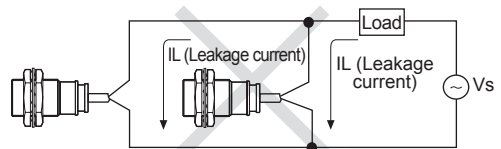

(Figure 4) The wrong way of parallel connection

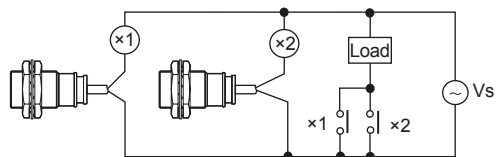

(Figure 5) The right way of parallel connection

(A)	Photoelectric Sensors
(B)	Fiber Optic Sensors
(C)	Door/Area Sensors
(D)	Proximity Sensors
(E)	Pressure Sensors
(F)	Rotary Encoders
(G)	Connectors/ Connector Cables/ Sensor Distribution Boxes/Sockets
(H)	Temperature Controllers
(I)	SSRs / Power Controllers
(J)	Counters
(K)	Timers
(L)	Panel Meters
(M)	Tacho / Speed / Pulse Meters
(N)	Display Units
(O)	Sensor Controllers
(P)	Switching Mode Power Supplies
(Q)	Stepper Motors & Drivers & Controllers
(R)	Graphic/ Logic Panels
(S)	Field Network Devices
(T)	Software

Proper Usage

Proper Usage

To using proximity sensors, please refer to the below instructions.

Power supply

DC type proximity sensor

Power of DC type proximity sensor should be used the rectified power by insulation transformer and ripple should be within 10%.

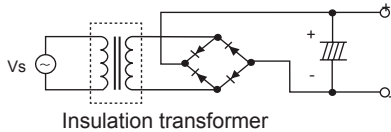

AC type proximity sensor

Supply power should be sine wave. Square wave of AC power may cause return error, etc.

Load

When wiring proximity sensor, be sure that the load should not be short by wrong connection of power, wrong wiring.

- DC 2-wire has polarity and be sure that the power polarity is properly connected.

Load connection can be connected to any direction.

Do not supply the power without loads, or inner element is damaged.

- DC 3-wire has built-in load short protection circuit but this protection circuit operates only for normal operation. Be sure that shorted output line with + power line or unproper polarity.
- AC 2-wire power is AC and there is no polarity. Load connection method is same as DC 2-wire method. Do not supply the power without loads, or inner element is damaged.

Wiring

Do not use the same conduit with cord of proximity sensor and electric power line or power line. Also avoid the same conduction, or it may cause malfunction.

It is possible to extend cable with over 0.3mm² and max. 200m.

If fast response is required and using extended cable, it may cause distortion phenomenon of output wave and it does not operate properly.

Sensing distance by material of sensing object

Material of the standard sensing object is magnetic metal (iron). Be sure that sensing distance of nonmagnetic metal (aluminum, etc) for a sensing object is shorten extremely.

Material	Sensing distance
Iron	100%
Stainless	Approx. 65%
Brass	Approx. 40%
Aluminum	Approx. 30%
Copper	Approx. 28%

Sensing distance by size of sensing object

If a sensing object is smaller than the standard sensing object, the sensing distance is shorten. If a sensing object is bigger than the standard sensing object, the sensing distance is constant. The below figure is characteristics data by changing one side of sensing distance per a (mm) based on 1mm thickness of square metal plate as a sensing object. E.g.) For PR30-10DN

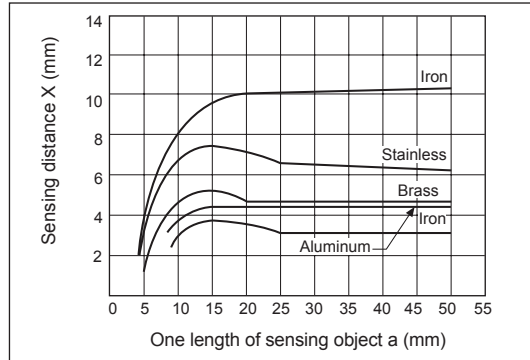

Sensing distance of thickness of sensing object

Thickness of standard sensing object is 1mm. If the thickness is over 1mm and sensing distance does not have any variation.

Even though material of a sensing object is nonmagnetic metal (aluminum, copper, etc) and the thickness is around 0.01mm, the sensing object has the same sensing distance as magnetic metal's. If a sensing object which is ultra thin by film, etc or has no conductive cannot be detected.

E.g.) Proximity sensor: PR18-8DN, Sensing object: Aluminum

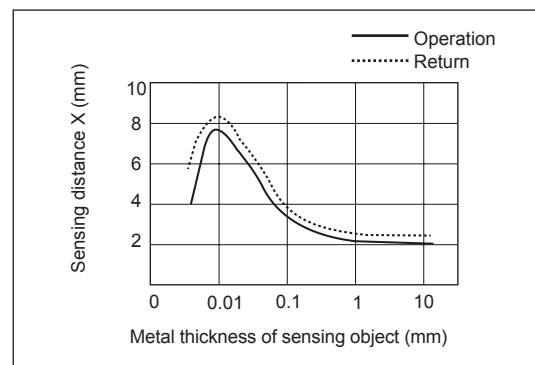

◎ Sensing distance by plate of sensing object

Refer to the below table for changing sensing distance by the plate of sensing objects.

- Effect by plate (examples of standards) (unit: %)

Applied metal	Iron	Brass
Thickness of plated type		
Not plated	100	100
Zn 5 to 15 μ m	90 to 120	95 to 105
Cd5 to 15 μ m	100 to 110	95 to 100
Ag 5 to 15 μ m	60 to 90	85 to 100
Cu 10 to 20 μ m	70 to 95	95 to 105
Cu 5 to 15 μ m	—	95 to 105
Cu 5 to 10 μ m + Ni (10 to 20 μ m)	70 to 95	—
Cu (5 to 15 μ m) + Ni (10 μ)+Cr (0.3 μ m)	75 to 95	—

※ Reference: % of not plated sensing object

◎ The characteristic of spatter-resistance type

The hot arc from arc welding machine is adhesive even with metals or plastics. Therefore, normal proximity sensor might have malfunction even though there are no sensing object if the arcs are put on the sensing surface. The arcs are not adhered on the sensing part of the spatter-resistance type proximity sensor as the part is coated with teflon against thermal resistance. Also, the protection cover sold optionally has the same function.

◎ Protection cover

If a proximity sensor is installed at the place where there are lots of arc when welding arc, use the protection cover to prevent a proximity sensor.

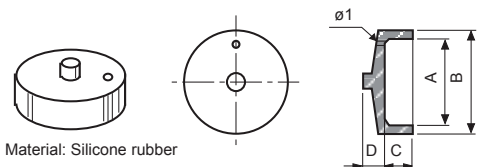

Item	Model	P90-M12	P90-M18	P90-M30
A		ϕ 11	ϕ 17	ϕ 28.5
B		ϕ 14	ϕ 21	ϕ 33
C		5.0	6.0	8.0
D		1.0	3.0	6.0
Applied sensor		M12	M18	M30

※Only for Flush (shield) type

◎ Fixing bracket for cylindrical proximity sensor

If fixing holes are not made for cylindrical proximity sensor, use a cylindrical fixing bracket as below.

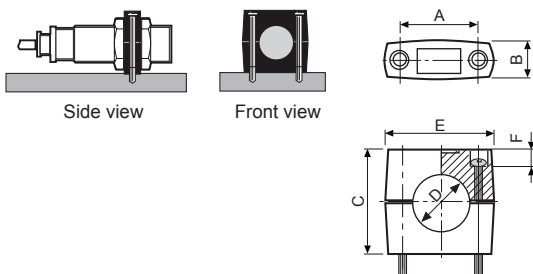

Item	Model	P90-R12	P90-R18	P90-R30
A		24 \pm 0.2	32 \pm 0.2	45 \pm 0.2
B		Max. 11.5	Max. 16	Max. 16
C		20	30	50
D		ϕ 12	ϕ 18	ϕ 30
E		Max. 34.4	Max. 47	Max. 60
F		6.0	10	10
Fixing bolt		M4 \times 20	M5 \times 30	M5 \times 50
Applied sensor		M12	M18	M30

※For Non-flush (non-shield) type, be sure effect by ambient material.

◎ Other causes

- When AC 2-wire proximity sensor is supplied to the power with noise, the inner circuit may be broken.

● Surge protection (AC 2-wire)

If there are machines (motor, welding, etc), which causes big surge around this unit, please install Varistor or absorber to source of surge, even though there is built-in surge absorber in this unit.

● Effect by leakage current (residual voltage)

DC 2-wire and AC 2-wire proximity sensor consumes a few of current to operate the circuit even though the power is OFF. This is called as leakage current. It may cause return error of load because there is small voltage (load residual voltage) at load. Please check that this voltage is below the return voltage of load (leakage current is below than return current of load)

-Refer to "● When operating current of load is not enough" of page D-149.

● Load with large inrush current (DC 2-wire, AC 2-wire)

When using load with big inrush current (lamp, motor, etc.), large inrush current flows due to low initial resistance value and it returns to steady state current by high resistance value after certain time. In this case, too large current flows at initial power and it may cause damage to inner circuit of proximity sensor. Use additional relay or current-limit resistance (R) to protect proximity sensor.

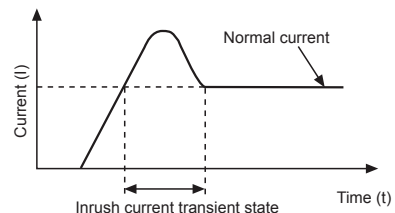
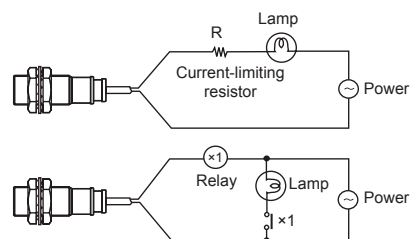

(A)	Photoelectric Sensors
(B)	Fiber Optic Sensors
(C)	Door/Area Sensors
(D)	Proximity Sensors
(E)	Pressure Sensors
(F)	Rotary Encoders
(G)	Connectors/ Connector Cables/ Sensor Distribution Boxes/Sockets
(H)	Temperature Controllers
(I)	SSRs / Power Controllers
(J)	Counters
(K)	Timers
(L)	Panel Meters
(M)	Tacho / Speed / Pulse Meters
(N)	Display Units
(O)	Sensor Controllers
(P)	Switching Mode Power Supplies
(Q)	Stepper Motors & Drivers & Controllers
(R)	Graphic/ Logic Panels
(S)	Field Network Devices
(T)	Software

Proper Usage

- Do not put overload to tighten nuts. Please use the washer for tightening.

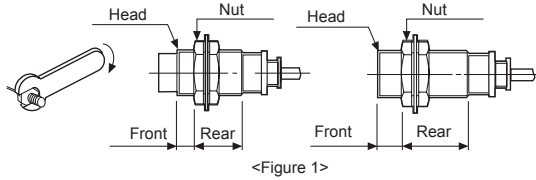

<Figure 1>

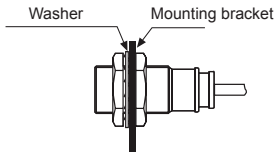

<Figure 2>

※Allowable tightening torque of nuts may be different by the distance from the head. For allowable tightening torque and the range of front and rear parts, refer to the below table. (front part is the range from head to size of the below table and rear part is including the nuts as the <Figure 1>. please apply the tightening torque of the front part when the nut on the front is located in the front part.)

※Allowable strength tightening (torque) denotes a torque value when using a provided washer as the <Figure 2>.

<Allowable strength tightening for nut>

Model	Strength	Front part		Rear part
		Size	Torque	Torque
PR08 Series	Flush	7mm	40kgf-cm (3.92N·m)	90kgf-cm (8.82N·m)
	Non-flush	5mm		
PR12/ PRD12 Series	Flush	13mm	65kgf-cm (6.37N·m)	120kgf-cm (11.76N·m)
	Non-flush	7mm		
PR18 / PRD18 Series	Flush	—	150kgf-cm (14.7N·m)	
	Non-flush	—		
PR30 / PRD30 Series	Flush	26mm	500kgf-cm (49N·m)	800kgf-cm (78.4N·m)
	Non-flush	12mm		

※ (1kgf-cm = 0.098N-m)

- Wrong wiring damages inner circuit. Check the wiring connection before supplying the power.
- Check the voltage range due not over the rated specifications for power input.
- Do not operate proximity sensor when supplying the power after 60ms, muting time of proximity sensor, or it may cause malfunction.
- Do not connect capacitive load directly to the unit which does not built-in short protection circuit for output. If it is over the rated load current, short protection circuit operates and if it is below the rated load current, it is cleared automatically.
- Turn OFF the power for wiring.
- Wire must be as short as possible in order to avoid noise.
- Be sure that for the plated sensing object, the sensing distance is varied by plating materials.
- If material dust sticks at the sensing part, it may cause malfunction.

- If the neck of wiring is move during operation, it may cause damage to wire. Make big bending radius.

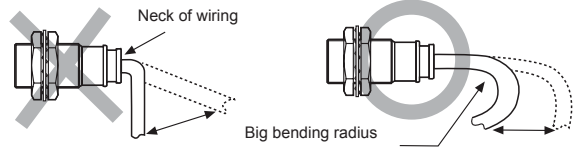

◎ Maintenance

For long-term using proximity sensor, check the below items.

- Installation environment for sensing target and proximity sensor, untightening of nut and distortion
- Untightening of wiring and connection, wrong connection, and disconnection
- Attached or accumulated metal dust at sensing part
- Setting distance
- Ambient environment and temperature

◎ Environment

To maintain stable operation, reliability and long life cycle, do not use this unit out of the rated temperature or outside. Proximity sensor has IP67 protection structure but use the cover not to touch water or cutting oil, etc. Do not use this unit at the place where there is chemicals such as acetic acid, strong alkaline, or chromate, etc.

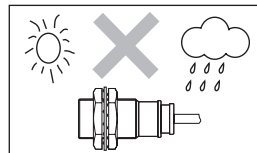

Do not use this unit outdoors.

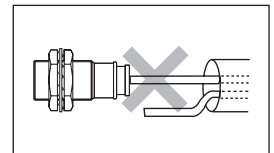

Do not use the same conduit with electric power line or power line, or it may cause malfunction.

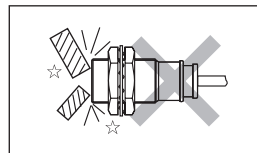

Sensing target should not hit the sensing side of proximity sensor.

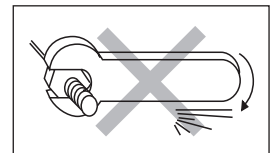

Do not put overload to tighten a nut.



Be sure to the strong chemicals such as acid or alkaline.

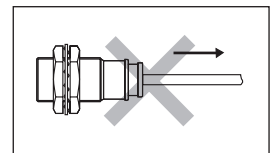

Do not pull over the cable with excessive load.

Protection Structure

- IEC (International Electrotechnical Commission)

IP

6



IEC (International Electrotechnical Commission) Standard (IEC 60529)

Protection against ingress of water.

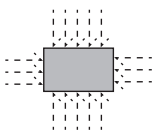
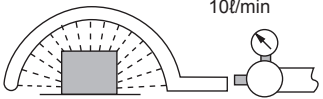
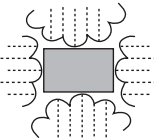
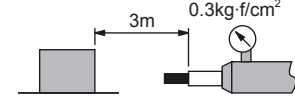
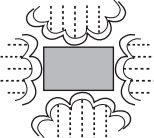
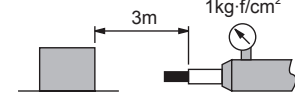
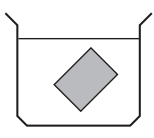
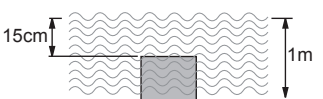
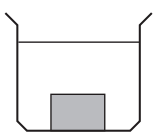
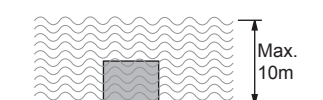
Code	Level of protection	Test method outline
4	 <p>No harmful effect of water spray from all direction</p>	<p>Splashing water from all direction for 10 min</p>  <p>10ℓ/min</p>
5	 <p>No harmful effect of water splash from all direction</p>	<p>Splashing water from all direction for 3 min</p>  <p>3m 0.3kg-f/cm²</p> <p>Diameter of discharging nozzle: Ø6.3</p>
6	 <p>No harmful effect of strong water jets from all direction</p>	<p>Splashing water from all direction for 3 min</p>  <p>3m 1kg-f/cm²</p> <p>Diameter of discharging nozzle: Ø12.5</p>
7	 <p>No harmful effect of water dip in certain level of pressure and length of time</p>	<p>Dip into 1m depth water for 30 min</p>  <p>15cm 1m</p>
8	 <p>No harmful effect against water sink</p>	<p>Dip into 10m depth water continually</p>  <p>Max. 10m</p>

Protection against solid object

Code	Level of protection	Test method outline
6	Dust tight	No ingress of dust; complete protection against contact

International Protection

(A) Photoelectric Sensors

(B) Fiber Optic Sensors

(C) Door/Area Sensors

(D) Proximity Sensors

(E) Pressure Sensors

(F) Rotary Encoders

(G) Connectors/ Connector Cables/ Sensor Distribution Boxes/Sockets

(H) Temperature Controllers

(I) SSRs / Power Controllers

(J) Counters

(K) Timers

(L) Panel Meters

(M) Tacho / Speed / Pulse Meters

(N) Display Units

(O) Sensor Controllers

(P) Switching Mode Power Supplies

(Q) Stepper Motors & Drivers & Controllers

(R) Graphic/ Logic Panels

(S) Field Network Devices

(T) Software