

# KRN50 Series

## Features

- 50mm thermal transfer method of paper recorder
- Data logger function for recording without paper
- Supports RS485 communication and dedicated communication port to set or monitor parameters in real-time by PC/PLC
- Multi-input with high accuracy 0.2% level (RTD, TC, Voltage, Current (shunt))
- 2-channel simultaneous recording in graphic mode and digital mode
- High visibility and easy setting by LCD dot matrix
- Supports various option I/O function
- Small size (W96×H96×L100mm), light weight



Please read "Caution for your safety" in operation manual before using this unit.

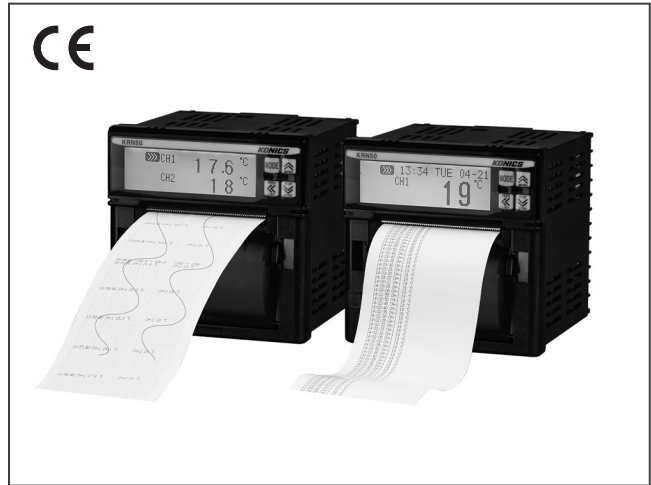

## Manual

- For more information and instructions, refer to the user manual and the user manual for communication. Visit our web site ([www.autonics.com](http://www.autonics.com)) to download the manuals.
- The user manual includes product specifications, functions, and operations.

## Integrated device management program (DAQMaster)

DAQMaster is the comprehensive device management program to set parameters and manage monitoring data. Visit our website ([www.autonics.com](http://www.autonics.com)) to download user manual and integrated device management program.

< Computer specification for using software >

Item	Minimum requirements
System	IBM PC compatible computer with Intel Pentium III or above
Operating system	Microsoft Windows 98/NT/XP/Vista/7/8/10
Memory	256MB or more
Hard disk	More than 1GB of free hard disk space
VGA	1024×768 or higher resolution display
Others	RS-232 serial port (9-pin), USB port

< DAQMaster screen >

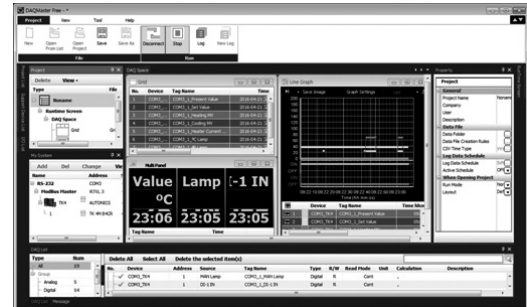

## Ordering information

Item	Value	Description
KRN50 - 2 0 0 4 - 4 0	0	100-240VAC 50/60Hz
	1	24VDC
Option output	0	None
	4	RS485 communication output
Alarm output	0	None
	2	Alarm output 2EA <sup>※1</sup>
CH2 control output	4	Alarm output 4EA <sup>※2</sup>
	0	None
CH1 control output	0	None
Number of input channels	1	1-channel
	2	2-channel
Item	KRN50	Thermal Line Recorder (50mm)

※ 1. When selecting this for 2CH model, two alarm outputs for CH1 are available. In other words, you cannot set one for CH1 and one for CH2.

※ 2. It is selectable only for 2CH model.

# 50mm Small Hybrid Recorder

## Connections

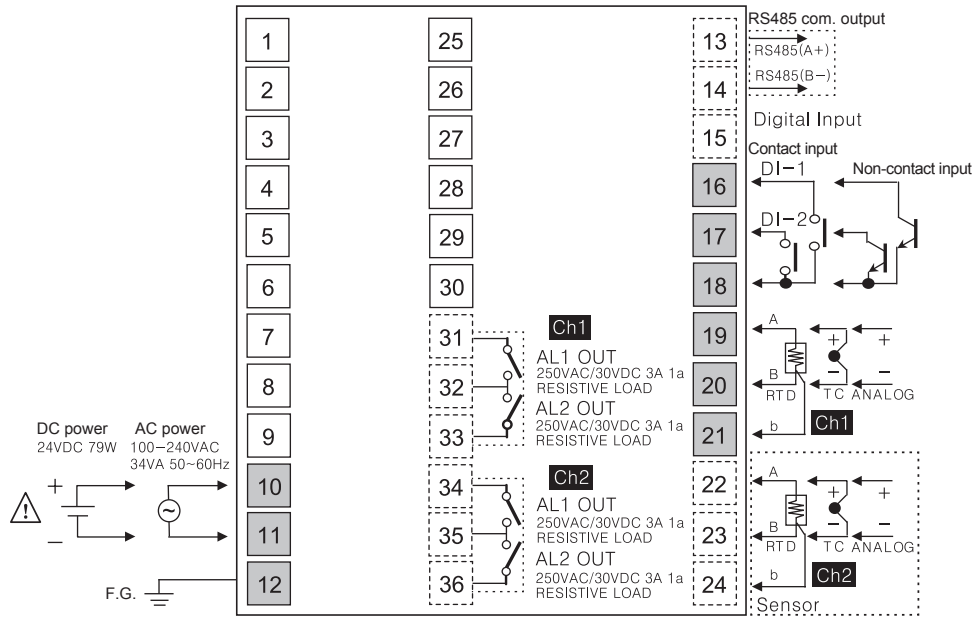

- ※ Shaded terminals are for the standard model. (power terminal, CH1 input terminal, DI input terminal)
- ※ Dot line terminals are for the option model. (CH2 input terminal, alarm output terminal, communication output terminal)
- ※ The DC power model does not have F.G.
- ※ When using 2-wire RTD, short B and b terminals.
- ※ For current input, connect external 50Ω B class (0.1%) high-accuracy resistor.

## Dimensions

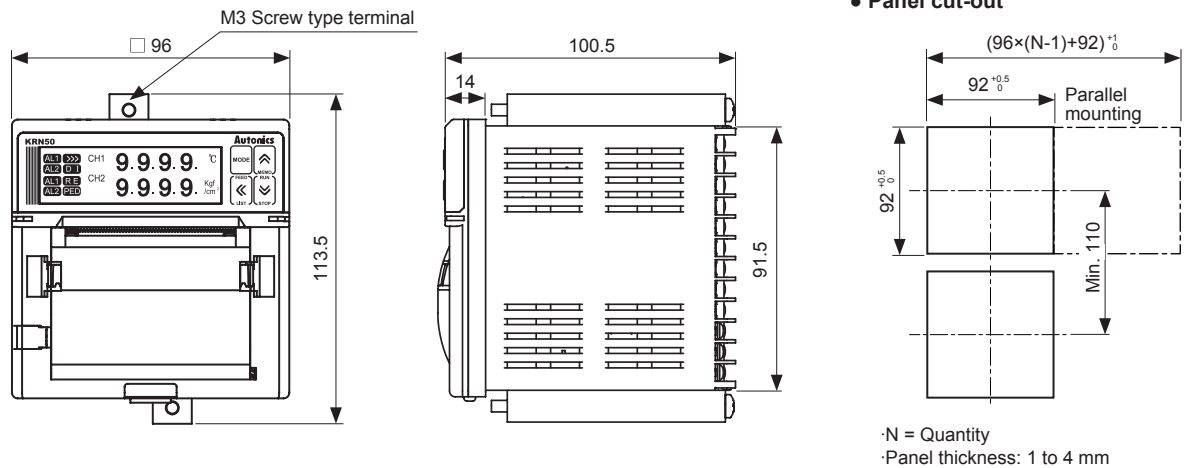

A. Recorders

B. Indicators

C. Converters

D. Controllers

E. Thyristor power controllers

F. Pressure transmitters

G. Temperature transmitters

H. Accessories

KRN1000

KRN100

KRN50

# KRN50 Series

## Specifications

Series	KRN50	
Power supply	AC voltage	100-240VAC 50/60Hz
	DC voltage	24VDC
Allowable voltage range	AC voltage	85 to 110% of rated voltage
	DC voltage	90 to 110% of rated voltage
Power consumption	AC voltage	Max. 34VA
	DC voltage	Max. 79W
Display method	LCD Dot matrix Display (resolution 128×32 Dot)	
Input type	RTD	JPt100Ω, DPt100Ω, DPt50Ω, Cu100Ω, Cu50Ω (5 types)
	TC	K, J, E, T, B, R, S, N, C, G, L, U, PLII (13 types)
	Analog	· Voltage: -50.0-50.0mV, -199.0-200.0mV, -1.000-1.000V, -1.00-10.00V (4 types) · Current: 0.00-20.00mA, 4.00-20.00mA (2 types) ※ For current input, connect external 50Ω B class (0.1%) high-accuracy resistor
Event input	Contact	Input ON: Max. 1kΩ, OFF: Min. 100kΩ
	Non-contact	Input ON: Residual voltage max. 1V, OFF: Leakage current max. 0.05mA
	Outflow current	Approx. 0.3mA
Display accuracy*1	RTD	At room temperature (25±5°C): ±0.2% F.S. ±1-digit Out of room temperature: ±0.3% F.S. ±1-digit (TC-K2 has same accuracy within -200 to 1350°C ofTC-K1.)
	TC	
	Analog	
Record accuracy	±0.5%F.S.	
Alarm output	CH1 (AL1, AL2), CH2 (AL1, AL2) Relay output (250VAC/30VDC 3A 1 a)	
Alarm output hysteresis	ON/OFF interval setting for alarm output: 1 to 999-digit variable	
Communication output	RS485 communication output (Modbus RTU protocol)	
Set method	Setting by front keys	
Sampling cycle	500ms/channel×2 channels = 1000ms	
Dielectric strength	2300VAC 50/60Hz for 1 min (charging terminal of the other polarity)	
Vibration	0.75mm amplitude at frequency of 10 to 55Hz (for 1 min) in each X, Y, Z direction for 1 hour	
Relay life cycle	Mechanical: Over 5,000,000 operations, Electrical: Over 100,000 operations	
Insulation resistance	Over 100MΩ (at 500VDC megger)	
Noise immunity	Square shaped noise by noise simulator (pulse width 1μs)±2kV	
Print	Method	Direct thermal line print
	Resolution	8-dot/mm
	Dots	384-dot/Line
	Life cycle	50km
Record	Graphic mode	· Record speed (recording paper speed): 10, 30, 60, 120, 240, 480, 960mm/hour · Memo cycle: 30s, 1m, 5m, 10m, 15m, 30m, 1h, 2h, 3h, 4h, 8h, 16h, 24h
	Digital mode	TEXT mode record cycle: 00m 05s to 99m 59s
	Paper	Thermal Direct Receipt Paper (57mm×16m)
	Paper supply method	Clamshell type
	Language	Korean, English
Environment	Ambient temperature	0 to 50°C, storage: -20 to 60°C
	Ambient humidity	35 to 85%RH, storage: 35 to 85%RH
Approval	CE	
Weight*2	Approx. 700g (approx. 470g)	

※ 1. ○ At room temperature (25±5°C)

- Thermocouple J (-200≤T≤100): (±0.2% F.S. or ±2.7°C2.0°C, select the higher one) ±1-digit
- Thermocouple R,S,C,G (0≤T≤100): (±0.2% F.S. or ±5.2°C2.0°C, select the higher one) ±1-digit
- Thermocouple U, T (-200≤T≤100): (±0.2% F.S. or ±3.5°C2.0°C, select the higher one) ±1-digit
- Thermocouple U, T (-100≤T≤400): (±0.2% F.S. or ±2.5°C2.0°C, select the higher one) ±1-digit
- Thermocouple B type, below 400°C: There is no accuracy standards.
- All thermocouples, below -100°C: (±0.4 F.S.) ±1-digit

※ 2. The weight includes packaging. The weight in parentheses is for unit only.

※ Environment resistance is rated at no freezing or condensation.

# 50mm Small Hybrid Recorder

## Input type and range

Input type		Dot	Display	Input range (°C)	Input range (°F)
Thermocouple	K(CA)	1	TC-K1	-200 to 1350	-328 to 2462
		0.1	TC-K2	-199.9 to 999.9	-199.9 to 999.9
	J(IC)	1	TC-J1	-200 to 800	-328 to 1472
		0.1	TC-J2	-199.9 to 800.0	-199.9 to 999.9
	E(CR)	1	TC-E1	-200 to 800	-328 to 1472
		0.1	TC-E2	-199.9 to 800.0	-199.9 to 999.9
	T(CC)	1	TC-T1	-200 to 400	-328 to 752
		0.1	TC-T2	-199.9 to 400.0	-199.9 to 752.0
	B(PR)	1	TC-B	100 to 1800	212 to 3272
	R(PR)	1	TC-R	0 to 1750	32 to 3182
	S(PR)	1	TC-S	0 to 1750	32 to 3182
	N(NN)	1	TC-N	-200 to 1300	-328 to 2372
	C(TT) ※1	1	TC-C	0 to 2300	32 to 4172
	G(TT) ※2	1	TC-G	0 to 2300	32 to 4172
	L(IC)	1	TC-L1	-200 to 900	-328 to 1652
0.1		TC-L2	-199.9 to 900.0	-199.9 to 999.9	
U(CC)	1	TC-U1	-200 to 400	-328 to 752	
	0.1	TC-U2	-199.9 to 400.0	-199.9 to 752.0	
Platinel II	1	TC-P	0 to 1390	32 to 2534	
RTD	Cu50Ω	0.1	CU50	-199.9 to 200.0	-199.9 to 392.0
	Cu100Ω	0.1	CU100	-199.9 to 200.0	-199.9 to 392.0
	JPt100Ω	1	JPT1	-200 to 600	-328 to 1112
		0.1	JPT2	-199.9 to 600.0	-199.9 to 999.9
	DPt50Ω	0.1	DPT50	-199.9 to 600.0	-199.9 to 999.9
	DPt100Ω	1	DPT1	-200 to 600	-328 to 1112
0.1		DPT2	-199.9 to 600.0	-199.9 to 999.9	
Analog	Voltage	-50.0 - 50.0mV	50mV	-1999 to 9999 (display range depends on the decimal point position)	
		-199.9 - 200.0mV	200mV		
		-1.000 - 1.000V	1V		
		-1.00 - 10.00V	10V		
	Current (shunt)	0 - 20mA	0-20		
		4 - 20mA	4-20		

※ 1. C(TT): Same as existing W5(TT) type sensor.

※ 2. G(TT): Same as existing W(TT) type sensor.

## Sold Separately

### ◎ Communication converter

● **SCM-US48I**  
(USB to RS485 converter)

CE



● **SCM-38I**  
(RS232C to RS485 converter)

CE



● **SCM-US**  
(USB to Serial converter)

CE



A. Recorders

B. Indicators

C. Converters

D. Controllers

E. Thyristor power controllers

F. Pressure transmitters

G. Temperature transmitters

H. Accessories

KRN1000

KRN100

KRN50

# KRN50 Series

## Part descriptions

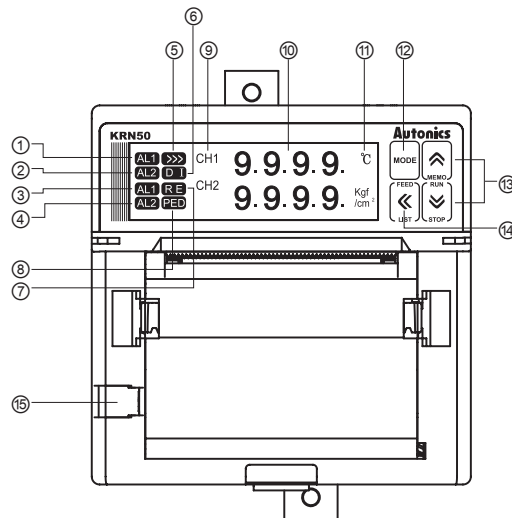

- ① CH 1 alarm (AL1) output indicator: Turns ON when AL1 of input channel 1 operates.
- ② CH 1 alarm (AL2) output indicator: Turns ON when AL2 of input channel 1 operates.
- ③ CH 2 alarm (AL1) output indicator: Turns ON when AL1 of input channel 2 operates.
- ④ CH 2 alarm (AL2) output indicator: Turns ON when AL2 of input channel 2 operates.
- ⑤ Recording start (▶▶▶)/Recording stop (■) indicator: ▶▶▶ turns ON when start recording (RUN). ■ turns ON when stopping recording (STOP).
- ⑥ Digital input indicator: Turns ON when setting digital input.
- ⑦ Recording reservation (RE) indicator: RE turns ON when recording reservation operates.
- ⑧ Recording paper status (PED) indicator: PED turns ON if running out of recording paper during recording (RUN).
- ⑨ Channel (CH) display part: Displays input channel of currently displayed PV on the PV display part.
- ⑩ PV display part: In RUN mode, displays PV of the current channel.  
In setting mode, displays parameters and mode setting values.
- ⑪ Unit display part: Unit of relevant channel is indicated.
- ⑫ MODE key: Used to enter setting mode and changing SV mode.
- ⑬ ◀, ▶ key: Used to move parameters or increase/decrease digits.  
- ◀ key: Digital memo key, ▶ key: Recording Run/Stop key
- ⑭ ⏪ key: Used to move parameters to upper group or move digits  
- Paper feeding key (STOP), printing parameter setting information key (RUN)
- ⑮ PC loading port: It is a PC loading port for serial communication to set or monitor parameters by PC.  
Used to connect SCM-US (USB to Serial converter, sold separately).

## Functions

### Input unit and Scale of temperature sensor

#### Ⓞ Temperature unit setting by input type [ CH □ Temp Unit ]

You can set the temperature unit as Celsius (°C), or Fahrenheit (°F) for each input temperature sensor.

When changing temperature unit for temperature sensor input (Celsius[ °C ] ↔ Fahrenheit[ °F ]) current PV is also changed by the conversion calculation.

For analog input type, this parameter [ CH □ Temp Unit ] is not displayed.

When changing temperature unit, the related bias value is initialized as 0. The other parameter values except bias maintains the existing values.

- Set range: °C / °F
- Factory default: °C (unit: -)

#### Ⓞ Graph high/low-limit scale value

For temperature sensor input type (TC, RTD), this function is to set the scale value of the recorded graph on recording paper. You can set the recording range to record the specified section detailed with curve of graph.

When the input exceeds the graph high/low limit scale range, it is recorded on the empty space of recording paper of at the left/right side of graph (approx. 1mm).

At the starting point of digital memo recording, even though input exceeds graph high/low limit scale range, the input within high/low limit input range is recorded as its actual value.

# 50mm Small Hybrid Recorder

## ◎ Graph low-limit scale value [ CH □ Lo Graph ]

This function is to set low limit scale value of graph within input range of each input type.

- Set range:  
Min. range by each sensor input type to Graph high limit scale value[ CH □ Hi Graph ]- F.S. 5%
- Factory default: -200 (unit: digit)
- ✗ For analog input type, this parameter is not displayed.

## ◎ Graph high-limit scale value [ CH □ Hi Graph ]

This function is to set high limit scale value of graph within input range of each input type.

- Set range:  
Graph low limit scale value[ CH □ Lo Graph ] + F.S. 5% to Max. range by each sensor input type
- Factory default: 1350 (unit: digit)
- ✗ For analog input type, this parameter is not displayed.

## ■ User input range

For analog input type, this function is to set input range. Set low limit input value[ CH □ Lo Range ] and high limit input value [ CH □ Hi Range ] to limit the input range.

- Set range  
Low limit input value: Min. input range to High limit input value -5% F.S.  
High limit input value: Low limit input +5% F.S. to Max. input range
- Factory default  
Low limit input value: Min. input range  
High limit input value: Max. input range

## ■ Input correction [ CH □ In Bias ]

This function is to correct the error occurring from TC, RTD or analog input out of allowable error range of this unit.

This is also available to correct error when a sensor cannot contact the subject position by calculating the error temperature.

Variable temperature sensors have accuracy level. Because high accuracy type is expensive, standard thermocouples are generally used. By executing this function, you can get more accurate temperature from standard thermocouples.

When executing input correction function, you should measure the error from a sensor accurately. If the measured error is not correct, error may be greater.

Set input correction value to each channel. [ CH1 In Bias, CH2 In Bias ]

When changing temperature unit (°C ↔ °F) for temperature sensor input type (TC or RTD), or input type, correction value is initialized as 0.

- Set range: -999 to 999
- Factory default: 0000 (unit: digit)

## ■ Display scale

For analog input, this function is to set (-1999 to 9999) for particular high/low limit value in order to display high/low limit value of measurement input. If measurement inputs are 'a' and 'b' and particular values are 'A' and 'B', it will display a=A, b=B as below graphs.

- Set range:  
Low limit scale, High limit scale: within F.S. range
- Factory default:  
Low limit scale: 0.0, High limit scale: 100.0

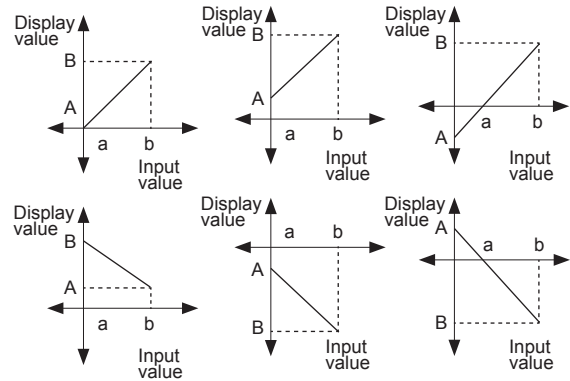

Display scale function is able to change display value for max./min. measured input by setting high limit scale [ Hi Scale ] and low limit scale [ Lo Scale ].

Ex) Set high/low scale value (input range is 0 to 10V)

- Lo Scale = 0.00
- Hi Scale = 5.00, 10.00, 15.00, -10.00

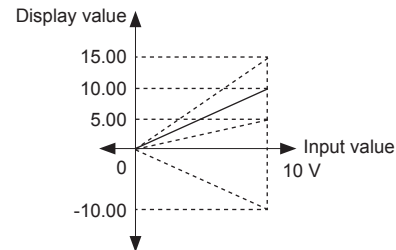

- Lo Scale = 10.00, Hi Scale = -10.00

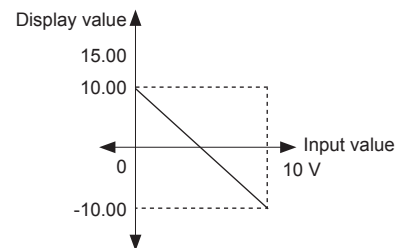

- Lo Scale = -5.00, Hi Scale = 5.00

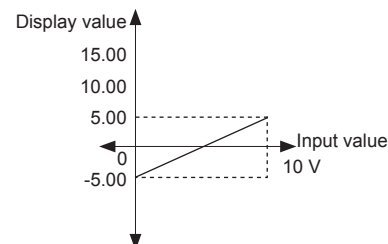

✗ When changing input type, high/low scale is changed as factory default.

A. Recorders

B. Indicators

C. Converters

D. Controllers

E. Thyristor power controllers

F. Pressure transmitters

G. Temperature transmitters

H. Accessories

KRN1000

KRN100

KRN50

# KRN50 Series

## ◎ Scale decimal point [ CH□ Sc Point ]

It is able to change decimal point position for high/low limit scale value. It changes decimal point position of display value (PV and SV, etc).

- Set range: 0 / 0.0 / 0.00 / 0.000
- Factory default: 0.0 (unit: -)

## ◎ Display unit [ CH□ Dp Unit ]

This function is to set unit for recording and displaying. This parameter is displayed only for analog input type at [ CH□ In Type ] parameter.

Even though changing analog input unit, PV is not converted different with temperature unit changing.

- Set range:  
°C, °F, %, ppm, V, mV, mA, Pa, kPa, pH, psi, kgf/cm<sup>2</sup>, m<sup>3</sup>/h, mmHg, mmH<sub>2</sub>O, us0 to us9
- Factory default: % (unit: -)

## ■ Alarm output [ Alarm Setup ]

Alarm output operates too high or low temperature/scale value of the subject during displaying temperature/scale value. When occurring alarm output by each channel, the related alarm indicators (CH1 = AL1, AL2 CH2 = AL1, AL2) turn ON.

If alarm output occurs during recording, it records that time, PV, and alarm information (AL HI =↑, AL LO =↓, SBA = B, P.End = P) on recording paper.

To divide HI and LO marks of AL1 and AL2, AL1 marks (↑↓) and AL2 marks (↑↓).

### ◎ Alarm operation [ CH□AL□ Type ]

Mode	Name	Record	Operation	Description
Off	No alarm	—	—	—
PV.Hi	High limit alarm	AL1=↑ AL2=↑		PV ≥ high limit alarm temperature (AL1.H) , alarm output is ON
PV.Lo	Low limit alarm	AL1=↓ AL2=↓		PV ≤ low limit alarm temperature (AL1.L) , alarm is ON
SBA	Sensor break alarm	AL1=B AL2=B	—	When input is not connected or disconnected during recording, alarm output is ON. You can check the input break using external alarm output contact by buzzer or others.
P.End	Paper end alarm	AL1=P AL2=P	—	If running out of recording paper during recording, alarm output is ON. (measured value is saved at system memory) When recording paper is replaced, alarm is cleared automatically (standard alarm) and P is printed on recording paper when printing back up data.

- Factory default: CH AL1 Type(PV.Hi), CH AL2 Type(PV.Lo)

### ◎ Alarm option [ CH□AL□ Opt ]

Option	Name	Description
None	Standard alarm	If it is an alarm condition, alarm output is ON. Unless an alarm condition, alarm output is OFF.
Latch	Alarm latch	If it is an alarm condition, alarm output is ON. An ON condition is latched. (Holding the alarm output)
StBy	Standby sequence	First alarm condition is ignored. From the second alarm condition, standard alarm operates. When power is ON and it is not an alarm condition, standard alarm operates.
La+St	Alarm latch and standby sequence	If it is an alarm condition, it operates both alarm latch and standby sequence. When power is ON and it is an alarm condition, it is ignored. From the second alarm condition, alarm latch operates.

- Factory default: None (unit: -)

### ◎ Alarm temperature setting [ CH□AL□ Lo ], [ CH□AL□ Hi ]

Set alarm value for each alarm output operation, if current value is the alarm value, alarm output is ON.

According to the alarm output operation mode [ CH□AL□Type ] setting, [ CH□AL□Lo ], [ CH□AL□Hi ] parameters of the channel is displayed.

※When selecting high limit alarm [ PV.Hi ], only [ CH□AL□High ] is displayed.

※When selecting low limit alarm [ PV.Lo ], only [ CH□AL□Low ] is displayed.

※When changing Input Type Setup[ CH□In Type ], [ CH□AL□High ] or [ CH□AL□Low ] value is changed within the input range of [ CH□In Type ].

※For temperature input type (TC or RTD), if burn occurs by sensor open when alarm temperature is set as [ CH□AL□Low ], the alarm operates.

- Set range: Within input type and range
- Factory default: [ CH□AL□Lo ]: Low limit scale value / [ CH□AL□Hi ]: High limit scale value (unit: °C/°F)

# 50mm Small Hybrid Recorder

## ◎ Alarm output hysteresis [ CH □ Alarm Hys ]

"H" of alarm output operation mode is hysteresis. Set ON and OFF interval of alarm output.

- Set range: 001 to 999 (decimal point position is same with that of input decimal point)
- Factory default: 001 (unit: digit)

## ◎ Example of alarm output

### ● High limit alarm [ PV.Hi ]

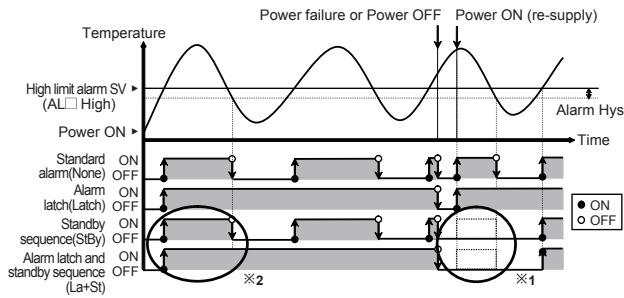

### ● Low limit alarm [ PV.Lo ]

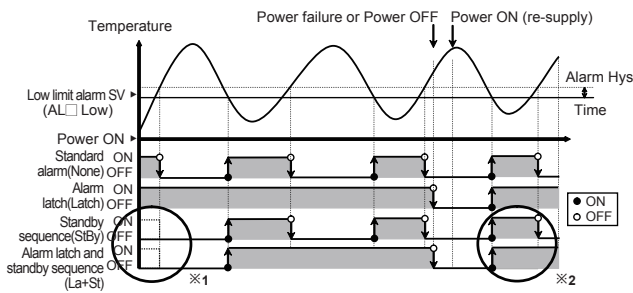

### ※ Standby sequence

When power is ON and it is alarm condition, this condition is ignored. From the second alarm condition, standard alarm operates. (Refer to ※1. of the above graph.)

When power is ON and it is not an alarm condition, standard alarm operates from the first condition. (Refer to ※2. of the above graph.)

- Conditions of re-applied standby sequence after occurring standby sequence:

Power ON, changing alarm value, or alarm clear forced

### ※ Alarm latch

If it is an alarm condition, alarm output is ON even though it is out of alarm range. (Holding the alarm output)

- Conditions of clear alarm latch:

To clear alarm latch, press the + keys for 3 sec when PV is below alarm value. For alarm latch by sensor break alarm (SBA) and no paper alarm (P.End), press the + keys for 3 sec to clear the alarm.

※ When changing alarm output operation mode [ CH □ AL □ Type ], alarm values [ CH □ AL □ High, Low ] are initialized as max./min. value automatically.

※ When changing alarm output option, the alarm value maintains the existing value.

## ■ Record mode [ Rec Mode ]

There are two modes; graph mode and digital mode to record current PV on recording paper.

- Set range: Graph / Digital
- Factory default: Graph (unit: -)

## ◎ Graph mode [ Graph Mode ]

Graph mode records PV with graph of curve on recording paper.

It records current date (year-month-day), high/low limit scale value of each channel by every 1 hour.

Depending on the set digital memo period [ Memo Period ], it records current time (hh:mm:ss) and PV of each channel periodically.

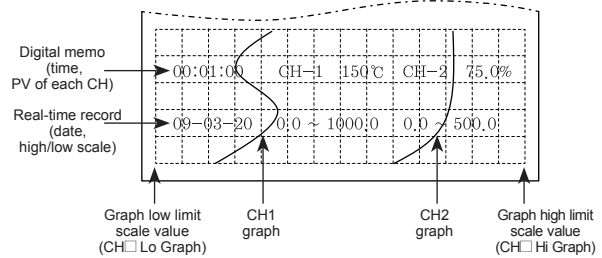

## ◎ Digital mode [ Digital Mode ]

Digital mode records PV with numerical value on recording paper. It records current time (hh:mm:ss) and PV of each channel periodically by the set print/record period [ Rec Period ].

For digital model, it records current date (year-month-day), high/low limit scale value of each channel by every 24 hours.

It records current PV by digital memo function through the front key ( key for 3 sec), DI input terminal (DI-2, 1sec) or communication.

00:02:00	CH-1	110°C	CH-2	75.0%
00:03:00	CH-1	110°C	CH-2	75.0%
00:01:00	CH-1	150°C	CH-2	75.0%
09-03-20	0 ~	1000	0 ~	500
23:59:00	CH-1	150°C	CH-2	72.0%
23:58:00	CH-1	120°C	CH-2	70.0%
23:57:00	CH-1	80°C	CH-2	58.0%

A. Recorders

B. Indicators

C. Converters

D. Controllers

E. Thyristor power controllers

F. Pressure transmitters

G. Temperature transmitters

H. Accessories

KRN1000

KRN100

KRN50



# KRN50 Series

## ■ Reservation record [ Reservation ]

Set the reservation record time in advance and it starts to record at the set record start time (RUN) and stops to record at the set record stop time (STOP).

•Ex) Record Setup                      Record Mode: Digital  
    Record Speed: 5sec  
    Reservation Setup      Start Time: 12:00  
    Stop Time: 12:02  
    (Record Start)12:00:00 → 12:00:05 .....  
    12:01:55 → 12:02:00(Record Stop)

To using reservation record function, set [ Reservation ] as 「On」 and record start time (Start Time) and record stop time (Stop time) parameters are displayed. It records during the set time.

When returning to RUN mode after setting reservation record, it stops recording and the Recording reservation (RE) indicator turns ON in display part.

When power is re-supplied by power failure during recording by reservation, if the time is within the reservation, it records continuously. Or not, it stops recording.

When setting [ Reservation ] as 「Off」 and record start time (Start Time) and record stop time (Stop Time) parameters are not displayed.

- Set range: Off (not using reservation record function)  
    On (using reservation record function)
- Factory default: Off

## ■ External digital input terminal

### ◎ DI-1 function [ Digital Input 1 ] : Record start (RUN)

This function is to operate record start (RUN) by external digital input terminals (16, 18).

When setting [ Digital Input1 ] as 「Run」, it operates recording at the set time of print/record period [ Rec Period ] on recording paper while external digital input terminal is short.

When starting DI-1 function at first, it records the current date and time as below.

- Korean: 현재시간 2009년03월19일 12시30분00초
- English: DATE 03-19-2009 12:30:00

When setting [ Digital Input1 ] as 「Off」, it does not operate any other function.

- Set range: Off / Run
- Factory default: Off (unit: -)

### ◎ DI-2 function [ Digital Input 2 ]: Digital memo

This function is to operate digital memo by external digital input terminals (17, 18).

When setting [ Digital Input2 ] as 「Memo」, it operates recording. It records current PV of each channel and current time (hh:mm:ss) when one signal is input to the external digital input terminal.

It is same memo function with by the front key (  key, 3sec).

When setting [ Digital Input2 ] as 「Off」, it does not operate any other function.

- Set range: Off / Memo
- Factory default: Off (unit: -)

## ■ Data save and re-recording when running out of recording paper

This recorder saves the measured data in inner memory and records it at recording paper after supplying the power. When running out of recording paper (P.End), this recorder cannot record the data but saves it.

After replacing recording paper, the message for whether record the un-recorded data at the display part.

Select All or Part and the recorder records the un-recorded data which is from the time of running out of recording paper. After recording this, normal recording continues.

Record previous data  
in memory ?  
All Part Cancel

- All (all of unrecorded data): Records/Prints the whole range data from the time of paper end to current time
- Part (part of unrecorded data): Records/Prints the set part (start time/stop time) data of the after time of paper end.
- Cancel (ignores not recording): Not record/print the saved data in memory and returns to RUN mode.
- Set range: All / Part / Cancel (unit: -)
- Factory default: Cancel

When running out of recording paper during recording (RUN) state, recording (RUN) state changes stop recording (STOP) state automatically.

## ■ Parameter setting information print [ List Print ]

This function is to record the parameter setting information on recording paper.

Press the  key for over 3 sec during recording, and it stops recording PV. After recording setting information of each menu, it records PV again.

- Recorded parameter:  
     tag name, input type, display unit, input range,  
     display range, alarm operation mode, alarm value,  
     communication

When starting record, depending on the setting of [RUN On State ] parameter, it records parameter setting information.

<p style="text-align: center;">현재시간 09년03월10일 12시10분10초</p> <p style="text-align: center;">※ 파라메타설정 ※</p> <table style="width: 100%; border-collapse: collapse;"> <tr> <td style="width: 33%;"></td> <td style="width: 33%;">채널 1</td> <td style="width: 33%;">채널 2</td> </tr> <tr> <td>채널명칭</td> <td>TEMP</td> <td>HUMI</td> </tr> <tr> <td>입력사양</td> <td>TC-K1</td> <td>mA</td> </tr> <tr> <td>표시단위</td> <td>℃</td> <td>%</td> </tr> <tr> <td>입력범위</td> <td>-200~1350</td> <td>4~20</td> </tr> <tr> <td>기록범위</td> <td>0~400</td> <td>0~1000</td> </tr> <tr> <td>경보1모드</td> <td>HIGH</td> <td>HIGH</td> </tr> <tr> <td>경보설정값</td> <td>300</td> <td>900</td> </tr> <tr> <td>경보2모드</td> <td>LOW</td> <td>LOW</td> </tr> <tr> <td>경보설정값</td> <td>150</td> <td>700</td> </tr> <tr> <td>통신기능</td> <td>RS485</td> <td>Modbus RTU</td> </tr> </table> <p style="font-size: small;">소형기록계 KRN50 www.autonics.com A/S : 032-820-2356-7</p>		채널 1	채널 2	채널명칭	TEMP	HUMI	입력사양	TC-K1	mA	표시단위	℃	%	입력범위	-200~1350	4~20	기록범위	0~400	0~1000	경보1모드	HIGH	HIGH	경보설정값	300	900	경보2모드	LOW	LOW	경보설정값	150	700	통신기능	RS485	Modbus RTU	<p style="text-align: center;">DATE 03-10-2009 12:10:10</p> <p style="text-align: center;">※ SETUP PARAMETER ※</p> <table style="width: 100%; border-collapse: collapse;"> <tr> <td style="width: 33%;"></td> <td style="width: 33%;">CH 1</td> <td style="width: 33%;">CH 2</td> </tr> <tr> <td>TAG NAME</td> <td>TEMP</td> <td>HUMI</td> </tr> <tr> <td>INPUT</td> <td>TC-K1</td> <td>mA</td> </tr> <tr> <td>UNIT</td> <td>℃</td> <td>%</td> </tr> <tr> <td>RANGE</td> <td>-200~1350</td> <td>4~20</td> </tr> <tr> <td>SCALE</td> <td>0~400</td> <td>0~1000</td> </tr> <tr> <td>ALARM 1</td> <td>HIGH</td> <td>HIGH</td> </tr> <tr> <td>VALUE</td> <td>300</td> <td>900</td> </tr> <tr> <td>ALARM 2</td> <td>LOW</td> <td>LOW</td> </tr> <tr> <td>VALUE</td> <td>150</td> <td>700</td> </tr> <tr> <td>INTERFACE</td> <td>RS485</td> <td>Modbus RTU</td> </tr> </table> <p style="font-size: small;">Recorder KRN50 www.autonics.com A/S : 82-32-820-2356-7</p>		CH 1	CH 2	TAG NAME	TEMP	HUMI	INPUT	TC-K1	mA	UNIT	℃	%	RANGE	-200~1350	4~20	SCALE	0~400	0~1000	ALARM 1	HIGH	HIGH	VALUE	300	900	ALARM 2	LOW	LOW	VALUE	150	700	INTERFACE	RS485	Modbus RTU
	채널 1	채널 2																																																																	
채널명칭	TEMP	HUMI																																																																	
입력사양	TC-K1	mA																																																																	
표시단위	℃	%																																																																	
입력범위	-200~1350	4~20																																																																	
기록범위	0~400	0~1000																																																																	
경보1모드	HIGH	HIGH																																																																	
경보설정값	300	900																																																																	
경보2모드	LOW	LOW																																																																	
경보설정값	150	700																																																																	
통신기능	RS485	Modbus RTU																																																																	
	CH 1	CH 2																																																																	
TAG NAME	TEMP	HUMI																																																																	
INPUT	TC-K1	mA																																																																	
UNIT	℃	%																																																																	
RANGE	-200~1350	4~20																																																																	
SCALE	0~400	0~1000																																																																	
ALARM 1	HIGH	HIGH																																																																	
VALUE	300	900																																																																	
ALARM 2	LOW	LOW																																																																	
VALUE	150	700																																																																	
INTERFACE	RS485	Modbus RTU																																																																	

<Korean>

<English>

# 50mm Small Hybrid Recorder

## Backup data recording [ Rec Backup ]

It is similar with data logger and it saves record data in inner memory.

Based on the saved back up data in inner memory, you can select whole range or part range of data to print.

When entering [ Rec BackUp ] parameter, it displays the fixed backup start time (Start) and current save time (Stop) to select the desired time within the saved time range as below.

```
Start: 03/09 12:01
Stop: 03/09 12:10
Graph Digital Cancel
```

In the screen, the current save time (Stop) is displayed as fixed to select the desired time range within the saved time range but in the product, this time is updated continuously.

After entering the parameter, change (Stop) to current time or re-entering the parameter and (Stop) displays the current time to print backup data of current time.

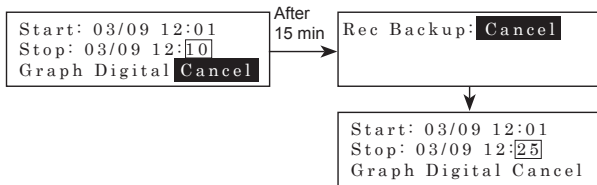

Data storage space of this product is 18138EA (for 1CH) and the save time is different by record mode as the below tables .

Backup data record supports graph mode and digital mode. To print the backup data which is the different mode from the saved record mode (ex: saved record mode: digital mode, to-be-printed record mode: graph mode), it prints the data by the record time (for digital mode) or cycle (for graph mode).

When the saved record mode of backup data is digital mode, the backup data save time is different by record time. (ex: record time of digital mode: 5 min, backup data save interval: 5 min, time changing of stop time: every 5min)

If the total record backup time is not over as below table, start time is fixed and only stop time is updated.

If the total record backup time is over as below table, from that time, both start time and stop time are updated.

- Set range: Cancel / Yes (unit: -)
- Factory default: Cancel

Graph Mode Rec Speed	Interval of saving time for 1 data	Total record backup time	
		2CH mode	1CH mode
960mm/h	0.5 sec	11542x0.5 sec = Approx. 1 hour 30 min	18138x0.5 sec = Approx. 2 hours 30 min
480mm/h	1 sec	Approx. 3 hours	Approx. 5 hours
240mm/h	2 sec	Approx. 6 hours	Approx. 10 hours
120mm/h	4 sec	Approx. 12 hours	Approx. 20 hours
60mm/h	8 sec	Approx. 24 hours	Approx. 40 hours
30mm/h	16 sec	Approx. 48 hours	Approx. 80 hours
10mm/h	48 sec	Approx. 6 days (153 hours)	Approx. 10 days (241 hours)

Digital Mode Rec Speed	Interval of saving time for 1 data	Total record backup time	
		2CH mode	1CH mode
5 sec	5 sec	11542x5 sec = Approx. 16 hours	18138x5 sec = Approx. 25 hours
1 min	60 sec	Approx. 8 days	Approx. 12 days
to	to	to	to
60 min	3600 sec	Approx. 480 days	Approx. 755 days
to	to	to	to
99 min 59 sec	6000 sec	Approx. 800 days	Approx. 1259 days

## Lock [ Setting Lock ]

It limits to check parameter set value and to change it.

Parameter	OFF	Loc1	Loc2	Loc3
Alarm Setup Reservation Setup	●	●	●	◐
Input Setup Record Setup Option Setup RS485 Setup	●	●	◐	○
Date/Time Setup Record Backup_Data Environment Setup	●	◐	○	○

- : Enable to check/set, ◐: Enable to check, disable to set,
- : Disable to check

Even though setting as 「Loc1」, 「Loc2」, 「Loc3」, [ Setting Lock ] parameter is displayed and you can change the setting.

- Factory default: Off (unit: -)

A. Recorders

B. Indicators

C. Converters

D. Controllers

E. Thyristor  
power  
controllers

F. Pressure  
transmitters

G. Temperature  
transmitters

H. Accessories

KRN1000

KRN100

KRN50

# KRN50 Series

## ■ Error

This product displays error messages when error occurs.

Message	Description
HHHH	<p>When input value is higher than the rated range, flashes in 0.5 sec. (automatically cleared when input value is within the rated range)</p> <p>• <b>Analog input</b></p> <p>Within <math>\pm 10\%</math> of input range F.S., LCD screen displays only PV and it records PV and HH or LL at the same time on recording paper as the 'a' of below figure. Over <math>\pm 10\%</math> of input range F.S., LCD screen and recording paper display HHHH, HH or LLLL, LL as the 'b' of below figure.</p> <p>For scale value, when Hi, Lo scale value is Hi &lt; Lo, it displays in reverse.</p> <p>For 0-20mA input, when Hi scale is set as 0, Lo scale is set 100 and input value is out of 20mA, it displays LLLL, not HHHH. <b>(HHHH, LLLL are not displayed in analog input 1V.)</b></p> <p>• <b>TC, RTD input</b></p> <p>Set Hi, Lo Graph values within the temperature range of each temperature sensor. When PV is over Hi, Lo Graph value, LCD screen displays only PV and it records PV and HH or LL at the same time on recording paper as the 'c' of below figure.</p> <p>Set Hi, Lo Graph values same as the temperature range of each temperature sensor.</p> <p>When PV is over Hi, Lo Graph value, LCD screen and recording paper display HHHH or LLLL as the 'd' of below figure.</p>
LLLL	<p>When input value is lower than the rated range, flashes in 0.5 sec. (automatically cleared when input value is within the rated range)</p> <p>In case of analog input, it flashes over 10%. <b>(HHHH, LLLL are not displayed in analog input 1V.)</b></p>
BURN	<p>Flashes when input is disconnected except 10V input. When input is connected, it cleared automatically.</p>
Time Set!!	<p>Displayed by wrong time setting for record backup and re-record of P.End or same start and stop time for reservation record.</p> <p>Press the <b>MODE</b> key to clear it and it returns to existing settings.</p>
Over range!!	<p>Displayed when setting value is over high/low limit value during setting Hi, Lo Graph and range in Input Type Setup.</p> <p>Press the <b>MODE</b> key to clear it and it returns to existing settings.</p>
Hi < Lo!!	<p>Displayed if setting value is Hi&lt;Lo or it is not within the rated range during setting Hi, Lo Graph and range in Input Type Setup. (ex: For TC-K1 of -200 to 1350°C, the range of high limit scale value is low limit scale value+F.S. 5% to max. input range of each input sensor 1350 to -122.5°C. In this case, SV is -123°C and Hi &lt; Lo!! error displays.) Press the <b>MODE</b> key to clear it and it returns to existing settings.</p>

When the related channel generates error operation, the corresponding message is recorded at the recording time of the channel.

As the below figure, HH and LL message displays when alarm does not occurs.

a	→	08:15:00	CH-1	5V	HH	CH-2	5V	HH
b	→	08:25:00	CH-1	HHHH°C	HH	CH-2	HHHH°C	HH
c	→	08:15:00	CH-1	170°C	LL	CH-2	170°C	LL
d	→	08:30:00	CH-1	LLLL°C	LL	CH-2	LLLL°C	LL

## ■ Communication

This function is to set or monitor parameters from external upper system (PC, PLC, etc) or transmit data to external devices by communication.

Communication is available by terminals or the front PC loading port. (refer to the connections for connecting terminals.)

You cannot use communications by terminals and the front front PC loading port at the same time. When connecting the front PC loading port with communication device, communication by terminals (transmission function of master) is blocked automatically.

### ◎ Interface

Comm. protocol	Modbus RTU
Connection type	RS485
Application standard	Compliance with EIA RS485
Max. connections	31units (address: 01 to 99)
Comm. synchronous method	Asynchronous
Comm. method	Two-wire half duplex
Comm. distance	Within max. 1 Km
Comm. speed	1200, 2400, 4800, 9600, 19200, 38400, 57600 bps
Comm. respond wait time	0.05 to 0.99sec
Start bit	1-bit (fixed)
Data bit	8-bit (fixed)
Parity bit	None, Odd, Even
Stop bit	1 or 2-bit

### ◎ Communication address [ Address ]

- Set range: 01 to 99
- Factory default: 01 (unit: -)

### ◎ Communication speed (Bit Per Second) [ Baud Rate ]

- Set range: 1200, 2400, 4800, 9600, 19200, 38400, 57600
- Factory default: 9600 (unit: bps)

### ◎ Parity Bit [ Parity Bit ]

- Set range: None, Even, Odd
- Factory default: None

### ◎ Stop Bit [ Stop Bit ]

- Set range: 1, 2
- Factory default: 2 (unit: Bit)

### ◎ Communication response wait time [ Resp Time ]

- Set range: 0.05 to 0.99
- Factory default: 0.05 (unit: sec)

# 50mm Small Hybrid Recorder

## ◎ Communication write enable/disable [ Com Write ]

This function is to enable or disable to change/write SV of the saved parameter by communication (PC/PLC). Reading of parameters is available.

- Enable: Enables to change/write SV of each parameter
- Disable: Disables to change/write SV of each parameter
- Set range: Enable / Disable
- Factory default: Enable (unit: -)

## ◎ Application of system organization

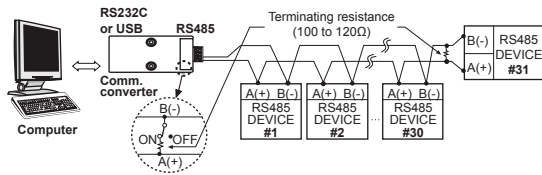

※ Only for RS485 communication output model.

※ It is recommended to use Autonics communication converter; SCM-US48I (USB to RS485 converter, sold separately), SCM-38I (RS232C to RS485 converter, sold separately), SCM-US (USB to Serial converter, sold separately). Please use twisted pair wire for RS485 communication.

## ■ Image download

### ◎ User unit download

You can download the desired unit as 16×16 size image (through DAQMaster, the integrated device management program). Select the user unit in setting mode.

### ◎ User logo download

User logo is recorded at the dotted box (384×80 size) of the below figure. You can download the desired logo as 384×80 size image (through DAQMaster, the integrated device management program) and check this when printing the list.

* SETUP PARAMETER *			* SETUP PARAMETER *		
TAG NAME	TEMP	HUMI	TAG NAME	TEMP	HUMI
CH 1			CH 1		
CH 2			CH 2		
INPUT	TC-K1	mA	INPUT	TC-K1	mA
UNIT	℃	%	UNIT	℃	%
RANGE	-200~1350	4~20	RANGE	-200~1350	4~20
SCALE	0~400	0~1000	SCALE	0~400	0~1000
ALARM 1	HIGH	HIGH	ALARM 1	HIGH	HIGH
VALUE	300	900	VALUE	300	900
ALARM 2	LOW	LOW	ALARM 2	LOW	LOW
VALUE	150	700	VALUE	150	700
INTERFACE	RS485	Modbus RTU	INTERFACE	RS485	Modbus RTU

<Before input>

<After input>

※ Be sure that downloading the user logo of 384×80 size may cause the problem due to increased current consumption and this image may not be printed normally. Please refrain from the image which has lots of dots. It is recommended to download the image which consists of characters as above.

### ◎ LCD booting image download

You can download the desired booting image to display on LCD screen (approx. 3 sec) when supplying the power.

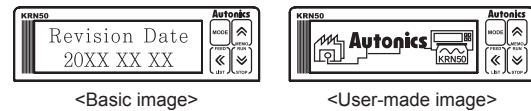

- To download the image, use DAQMaster, the integrated device management program. (When initializing boot image download function of DAQMaster, the booting logo image changes as the left basic image.)
- Basic boot image displays program revision date as fixed.
- Image size should be 128×32 size.

※ For more functions, refer to the user manual of KRN50.

A. Recorders

B. Indicators

C. Converters

D. Controllers

E. Thyristor power controllers

F. Pressure transmitters

G. Temperature transmitters

H. Accessories

KRN1000

KRN100

KRN50

# KRN50 Series

## Parameters

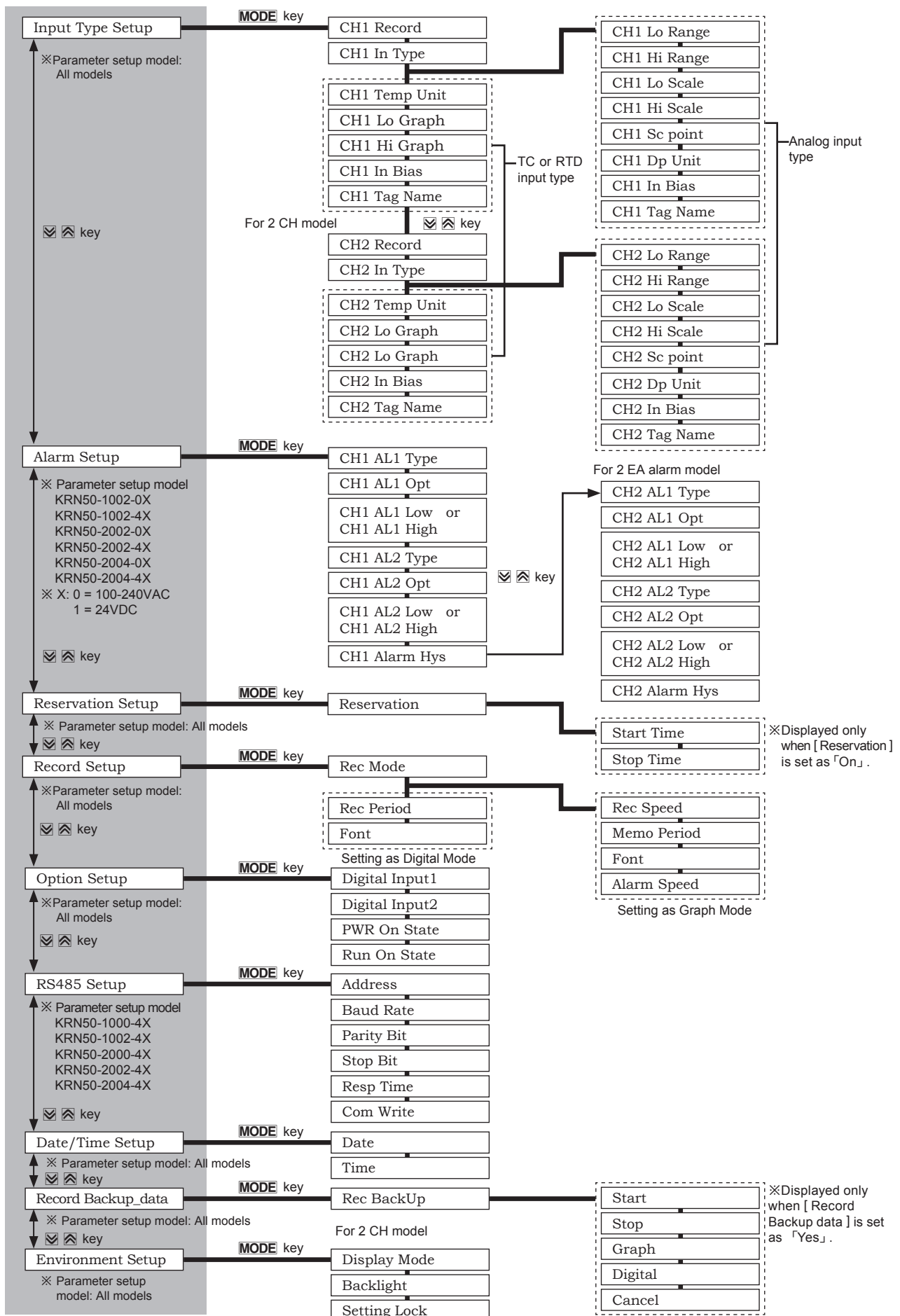

# 50mm Small Hybrid Recorder

## Factory default

### Input type setup group [ Input Type Setup ]

Parameter	Default	Parameter	Default	Parameter	Default	Parameter	Default
CH1 Record	On	CH1 Lo Scale <sup>※2</sup>	000.0	CH2 Record <sup>※3</sup>	On	CH2 Lo Scale <sup>※3</sup>	000.0
CH1 In Type	TC.K1	CH1 Hi Scale <sup>※2</sup>	100.0	CH2 In Type <sup>※3</sup>	TC.K1	CH2 Hi Scale <sup>※3</sup>	100.0
CH1 Temp Unit <sup>※1</sup>	℃	CH1 Hi Scale Decimal Point <sup>※2</sup>	0.0	CH2 Temp Unit <sup>※3</sup>	℃	CH2 Hi Scale Decimal Point <sup>※3</sup>	0.0
CH1 Lo Graph <sup>※1</sup>	-200	CH1 DP Unit <sup>※2</sup>	%	CH2 Lo Graph <sup>※3</sup>	-200	CH2 DP Unit <sup>※3</sup>	%
CH1 Hi Graph <sup>※1</sup>	1350	CH1 In Bias	0000	CH2 Hi Graph <sup>※3</sup>	1350	CH2 In Bias <sup>※3</sup>	0000
CH1 Lo Range <sup>※2</sup>	—	CH1 Tag Name	CH-1	CH2 Lo Range <sup>※3</sup>	—	CH2 Tag Name <sup>※3</sup>	CH-2
CH1 Hi Range <sup>※2</sup>	—			CH2 Hi Range <sup>※3</sup>	—		

※ 1. Displayed only when input type (In Type) is temperature sensor (TC or RTD).

※ 2. Displayed only when input type (In Type) is analog (voltage/current).

※ 3. Displayed only for 2-channel model

### Alarm output setup group [ Alarm Setup ]

Parameter	Default	Parameter	Default	Parameter	Default	Parameter	Default
CH1 AL1 Type	PV.Hi	CH1 AL2 Opt	None	CH2 AL1 Type <sup>※2</sup>	PV.Hi	CH2 AL2 Opt <sup>※2</sup>	None
CH1 AL1 Opt	None	CH1 AL2 Low <sup>※1</sup>	-200	CH2 AL1 Opt <sup>※2</sup>	None	CH2 AL2 Low <sup>※1,※2</sup>	-200
CH1 AL1 Low <sup>※1</sup>	-200	CH1 AL2 High <sup>※1</sup>	1350	CH2 AL1 Low <sup>※1,※2</sup>	-200	CH2 AL2 High <sup>※1,※2</sup>	1350
CH1 AL1 High <sup>※1</sup>	1350	CH1 Alarm Hys	001	CH2 AL1 High	1350	CH2 Alarm Hys <sup>※2</sup>	001
CH1 AL2 Type	PV.Lo			CH2 AL2 Type <sup>※2</sup>	PV.Lo		

※ These parameters are displayed only for alarm output model.

※ 1. These are related with the setting of alarm output operation mode (AL□ Type) .

· CH□AL□ Type (Off, SBA or P.End): CH□AL□ Low, CH□AL□ High parameters are not displayed.

· CH□AL□ Type (PV.Hi): CH□AL□ High parameter is not displayed.

· CH□AL□ Type (PV.Lo): CH□AL□ Low parameter is not displayed.

※ 2. Displayed only for 2-channel model.

### Reservation record setup group [ Reservation Setup ]

Parameter	Default	Parameter	Default	Parameter	Default
Reservation <sup>※1</sup>	Off	Start Time	00:00	Stop Time <sup>※1</sup>	00:01

※ 1. Displayed only when (Reservation) is set as 「On」 .

### Record mode setup group [ Record Setup ]

Parameter	Default	Parameter	Default	Parameter	Default
Rec Mode	Graph	Memo Period <sup>※1</sup>	30min	Font	English
Rec Speed <sup>※1</sup>	10mm/h	Rec Period <sup>※2</sup>	01m00s	Alarm Speed	10mm/h

※ 1. Displayed only when (Rec Mode) is set as 「Graph」 .

※ 2. Displayed only when (Rec Mode) is set as 「Digital」 .

### Option setup group [ Option Setup ]

Parameter	Default	Parameter	Default	Parameter	Default	Parameter	Default
Digital Input 1	Off	Digital Input 2	Off	PWR On State	Run	Run On State	List

### RS485 communication setup group [ RS485 Setup ] (Read Only)

Parameter	Default	Parameter	Default	Parameter	Default
Address	01	Parity bit	None	Response Time	0.05s
Baud Rate	9600bps	Stop Bit	2	Com Write	Enable

### Environment setup group [ Environment Setup ]

Parameter	Default	Parameter	Default	Parameter	Default
Display Mode	2CH	Backlight	Temp	Setting Lock	Off

A. Recorders

B. Indicators

C. Converters

D. Controllers

E. Thyristor  
power  
controllers

F. Pressure  
transmitters

G. Temperature  
transmitters

H. Accessories

KRN1000

KRN100

KRN50

## Proper usage

- Do not use the unit outdoors. Failure to follow this instruction may result in electric shock or shorten the life cycle of the unit.
- When connecting the power input or measuring input, power cable should be over AWG20(0.50mm<sup>2</sup>). Make sure to tighten the terminal screw bolt above 0.74 N·m to 0.90 N·m. Use the unit within the rated specifications. Failure to follow this instruction may result in fire or shorten the life cycle of the unit.
- Do not use loads beyond the rated switching capacity of the relay contact. Failure to follow this instruction failure, contact melt, contact failure, relay broken, or fire, etc.
- When connecting magnet contact as load of relay contact output, connect surge absorber on coil part of contact. Failure to follow this instruction may result in malfunction.
- Do not use water or oil-based detergent when cleaning the unit. Use dry cloth to clean the unit. Failure to follow this instruction may result in electric shock or fire.
- Do not use the unit where flammable or explosive gas, humidity, direct sunlight, vibration, or impact may be present. Failure to follow this instruction may result in fire or explosion.
- Keep dust and wire residue from flowing into the unit. Failure to follow this instruction may result in fire or malfunction.
- Check the polarity of the power contact before wiring the unit. Failure to follow this instruction may result in fire or explosion.
- Check the polarity of the terminal when connecting a temperature sensor to the unit. Failure to follow this instruction may result in cause malfunction.
- Check the connection diagram of this manual before supplying power. Failure to follow this instruction may result in fire.
- Do not touch terminal during dielectric or insulation resistance test. Failure to follow this instruction may result in electric shock.
- Use insulation transformer and noise filter power for too much noise from the power. Attach noise filter on the grounded panel, etc. Use short cables for noise filter output part and power terminal of the unit. Failure to follow this instruction may result in product damage, malfunction by surge, etc.

# 50mm Small Hybrid Recorder

## MEMO

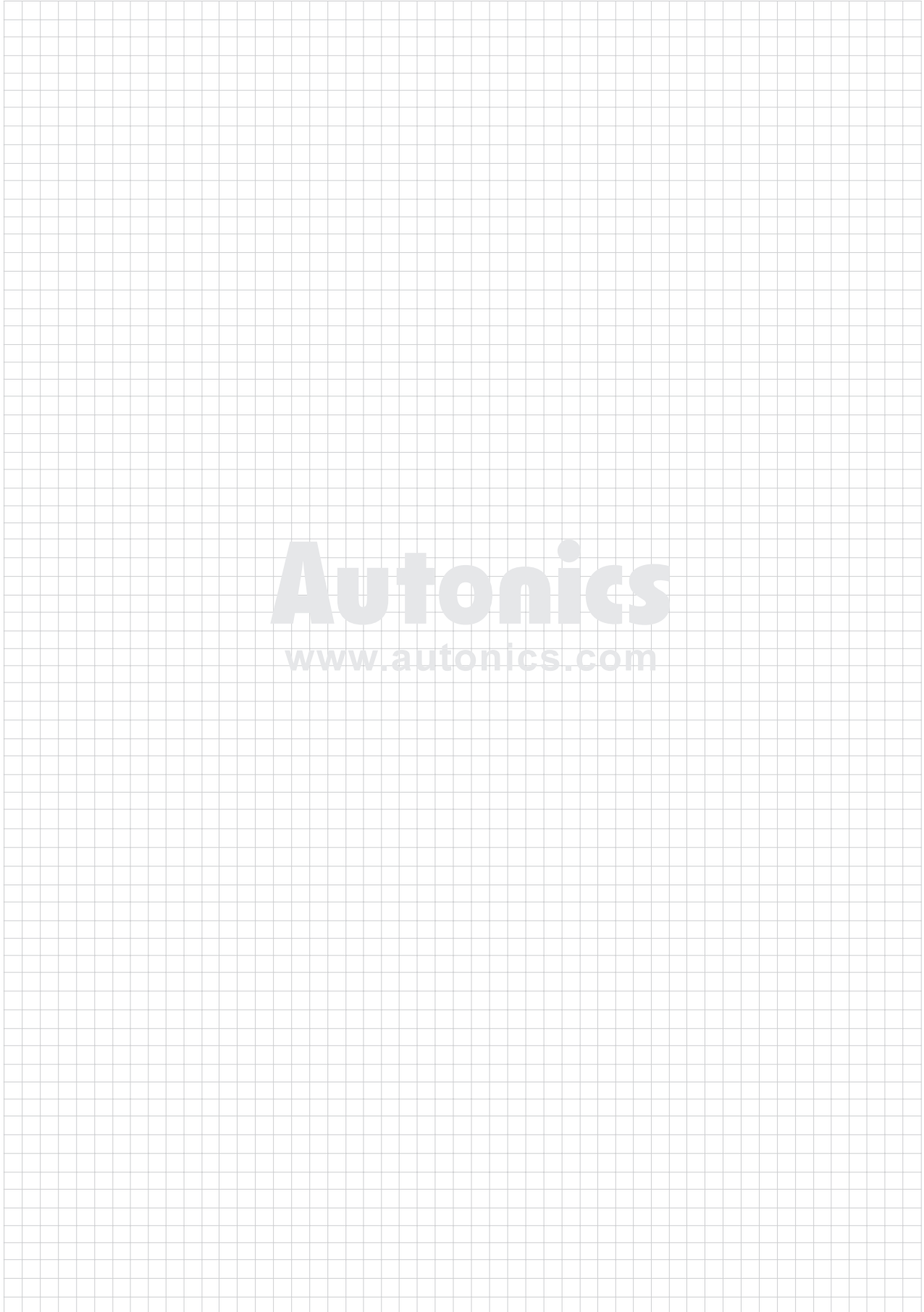

A. Recorders

B. Indicators

C. Converters

D. Controllers

E. Thyristor  
power  
controllers

F. Pressure  
transmitters

G. Temperature  
transmitters

H. Accessories

KRN1000

KRN100

KRN50