

# Autonics

## 100mm Hybrid Recorder

# KRN100 SERIES

## INSTRUCTION MANUAL

Thank you for choosing our Autonics product.  
Please read the following safety considerations before use.

### ■ Safety Considerations

※Please observe all safety considerations for safe and proper product operation to avoid hazards.

※Safety considerations are categorized as follows.

**Warning** Failure to follow these instructions may result in serious injury or death.

**Caution** Failure to follow these instructions may result in personal injury or product damage.

※The symbols used on the product and instruction manual represent the following

▲ symbol represents caution due to special circumstances in which hazards may occur.

### ▲ Warning

1. **Fail-safe device must be installed when using the unit with machinery that may cause serious injury or substantial economic loss.** (e.g. nuclear power control, medical equipment, ships, vehicles, railways, aircraft, combustion apparatus, safety equipment, crime/disaster prevention devices, etc.)

Failure to follow this instruction may result in personal injury, fire, or economic loss.

2. **The unit must be installed on a device panel before use.**

Failure to follow this instruction may result in electric shock.

3. **Do not connect, repair, or inspect the unit while connected to a power source.**

Failure to follow this instruction may result in electric shock.

4. **Do not disassemble or modify the unit. Please contact us if necessary.**

Failure to follow this instruction may result in electric shock or fire.

5. **Check the terminal numbers before connecting the power source.**

Failure to follow this instruction may result in fire.

### ▲ Caution

1. **Do not use the unit outdoors.**

Failure to follow this instruction may result in shortening the life cycle of the unit, or electric shock.

2. **Use the unit within the rated specifications.**

Failure to follow this instruction may result in shortening the life cycle of the unit, or fire.

3. **Do not use water or oil-based detergent when cleaning the unit. Use dry cloth to clean the unit.**

Failure to follow this instruction may result in electric shock or fire.

4. **Do not use the unit where flammable or explosive gas, humidity, direct sunlight, radiant heat, vibration, or impact may be present.**

Failure to follow this instruction may result in fire or explosion.

5. **Keep dust and wire residue from flowing into the unit.**

Failure to follow this instruction may result in fire or product damage.

6. **Check the polarity of the power contact before wiring the unit.**

Failure to follow this instruction may result in fire or explosion.

※Please read "Safety Considerations" in KRN100 user manual before using.

### ■ Specifications

Series	KRN100	
Power voltage	100-240VAC 50/60Hz	
Allowable voltage range	85 to 110% of rated voltage	
Power consumption	Max. 55VA	
Screen	LCD type	STN Graphic LCD
	Resolution	320×120 Pixel
	Adjusting brightness	4-level (OFF/Min/Standard/Max)
	Backlight	White LED, 2-level (Temp/Always)
Input channels	2 / 4 / 6 / 8 / 10 / 12-channel (2-channel/card)	
Universal input	Temperature sensor (RTD, thermocouple), analog (voltage, current)	
Sampling period	1 to 4-channel: 25ms/125ms/250ms, 5 to 12-channel: 125ms/250ms (inner sampling period is operation unit time for average movement filter and alarm output function.) ※Min. sampling period for TC-R, U, S, T sensor is 50ms.	
Recording speed in graph mode	10, 20, 40, 60, 120, 240mm/H	
Recording speed accuracy	F.S. ±0.5%	
Storage cycle	1 to 3600 sec (storage interval time to inner log file is 1 sec)	
Inner memory	512MB	
USB memory	User purchased, recognizes max. 32GB, enables to use cable up to 1.5m	
Dielectric voltage	2500VAC 50/60Hz for 1 min (power terminal and case) ※Excludes USB Device and Ethernet	
Vibration strength (for convey and storage) and operating vibration	Vibration strength: 10 to 60Hz 4.9m/s <sup>2</sup> (each X, Y, Z axis for 1 hour) Operating vibration: 10 to 60Hz 1m/s <sup>2</sup> (each X, Y, Z axis for 10 min)	
Insulated resistance	Min. 20MΩ (at 500VDC megger)	
Noise	±2kV the square wave noise (pulse width 1μs) by the noise simulator	
Time accuracy	Within ±2 min/year (enables to use up to 2100 year)	
Mechanism	Ink cartridge	Enables to normal print with going and returning printing max. 5 times within 7 days after opening the unit
	Ink dry time	Max. 15 minutes
Protection	IP40 (for front panel)	
Recording paper	113mm×9m	
Environment	Ambient temperature	0 to 50°C, storage: -20 to 60°C (without ink cartridge)
	Ambient humidity	35 to 85%RH, storage: 35 to 85%RH
Approval	CE, RoHS	
Weight※1	Approx. 2.4 to 2.7kg (approx. 1.7 to 2.0kg)	

※1: The weight includes packaging. The weight in parentheses is for unit only.

※Environment resistance is rated at no freezing or condensation.

### ■ Dimensions

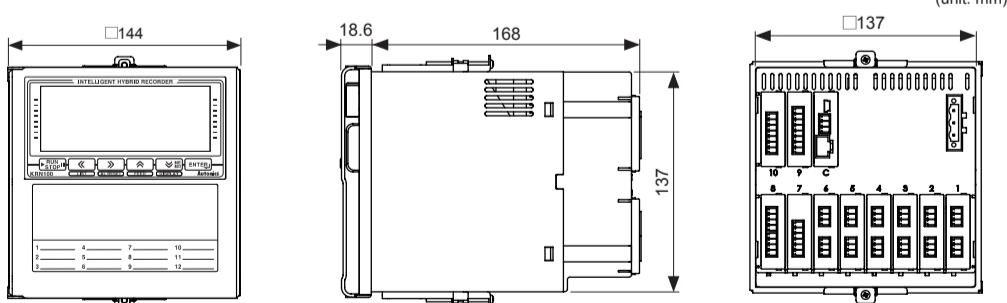

#### ● Panel cut-out

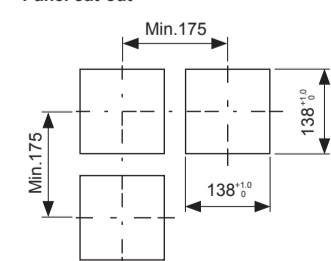

※Use a steel plate which is 2 to 8mm thickness.

※The above specifications are subject to change and some models may be discontinued without notice.

### ■ Connections

This figure is the rear side of KRN100-04000-00-0S.

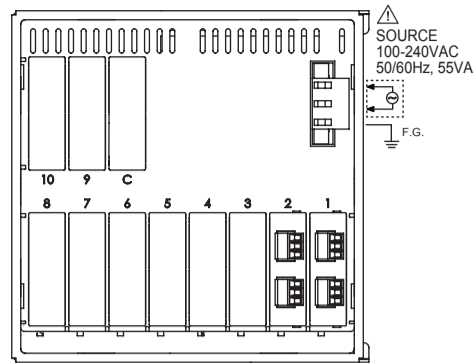

Slot	Description
1 to 6	Connects universal input card (KRN-UI2).
7 to 10	Connects digital input card (KRN-DI6), alarm output card (KRN-AR4, KRN-AT6), transmitter power output card (KRN-24V3).
C	Connects communication output card (KRN-COM).

### ■ Input Type Setting

Before setting the parameters, set the jumper pin channel 1/2 of universal input card (KRN-UI2) depending on input specification as below figure.

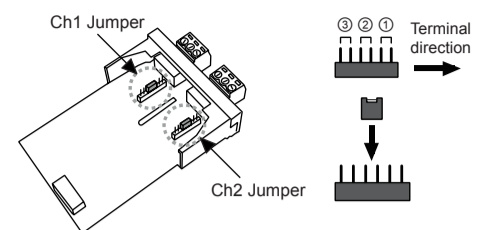

Jumper pin	Input specification	Input break alarm
①	0 to 20mA, 4 to 20mA	Enables only 4 to 20mA
②	TC, RTD, ±60mV, ±200mV	Enables
③	±2V, 1 to 5V, ±5V, -1 to 10V	Disables

### ■ User Manual

For the detail information and instructions, please refer to user manual and user manual for communication. Download manuals from the enclosed CD-ROM or our web site (www.autonics.com).

### ■ I/O Card

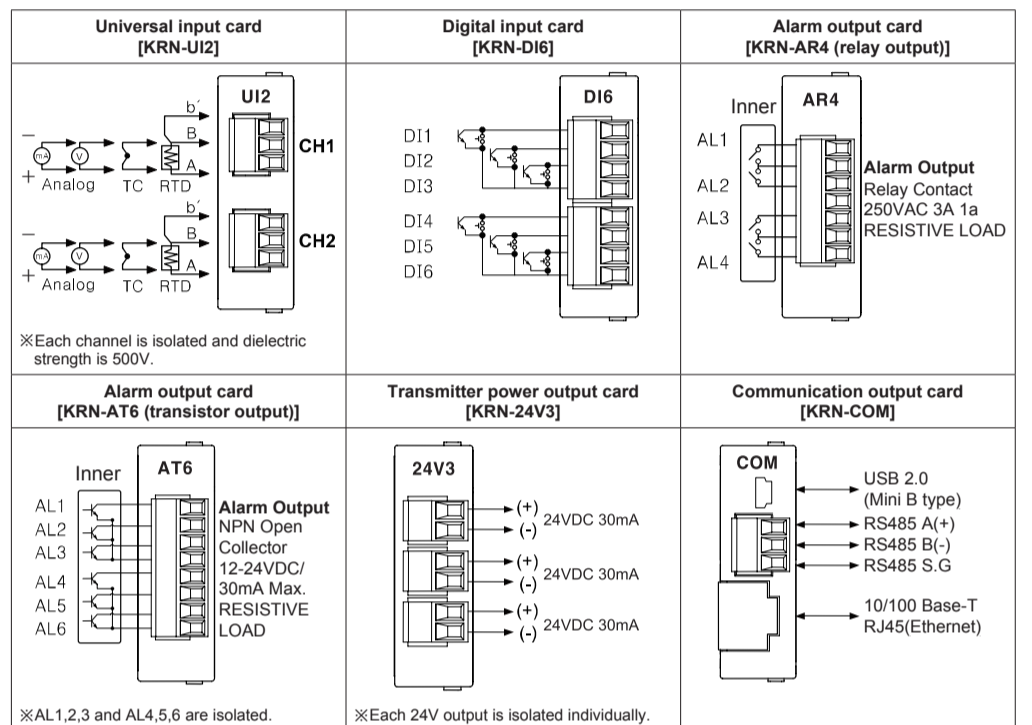

### ■ Screen Layout And Status Display

Screen layout is divided as two; upper screen for status display, lower screen for measuring value display, virtual keyboard display, parameter setting display. Upper screen displays recorder status and information of recorder as icon.

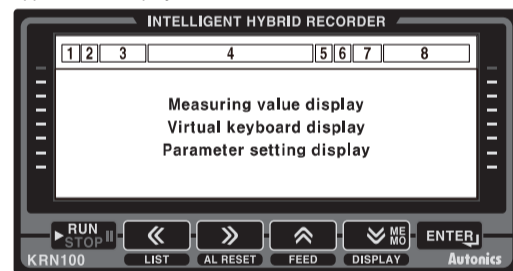

Section	Icon	Name	Description
1	▶	Record start icon	Marks if for starting recording measuring value of recordable channels.
	■	Record stop icon	Stops recording measuring value.
	▶	List record icon	Flashes during list recording.
	RE	Reservation record icon	Flashes during reservation recording.
	FEED	FEED icon	Flashes during feeding recording paper.
	RECORD BACKUP	Backup data print icon	Flashes during backup data printing.
2	Digital mode icon	Digital mode icon	Marks it for digital record mode.
	Graph mode icon	Graph mode icon	Marks it for graph record mode.
	Record memory status icon	Record memory status icon	Marks it storage capacity of record memory in digital mode or graph mode.
	No recording paper icon	No recording paper icon	Marks it for no recording paper. Please replace new recording paper.
3	USB communication icon	USB communication icon	Marks USB icon during Modbus RTU communication using USB.
	Ethernet communication icon	Ethernet communication icon	Marks Ethernet icon during Modbus TCP communication using Ethernet.
	RS485 communication icon	RS485 communication icon	Marks RS485 icon during Modbus RTU communication using RS485.
4	1 2 12	Alarm ON icon	Marks 1 2 ... 12 channel icon which alarm occurs.
	Digital input(DI) icon	Digital input(DI) icon	Marks the below icon according to input function setting during digital input (DI).
	ME MO!	Digital input(DI)-memo icon	Marks it when digital memo of digital input or front MEMO is input in recording status.
	RE SET	Digital input(DI)-alarm reset icon	Marks it when alarm reset signal of digital input (DI) is input.
	RUN	Digital input(DI)-start record icon	Marks it when start record signal of digital input (DI) is input.
	ST OP	Digital input(DI)-stop record icon	Marks it when stop record signal of digital input (DI) is input.
	LI ST	Digital input(DI)-LIST output icon	Marks it when LIST output signal of digital input (DI) is input.
	SP EED	Digital input(DI)-record speed icon	Marks it when changing record speed signal of digital input (DI) is input.
6	Unlock icon	Unlock icon	Marks it for unlock status.
	User(lock) icon	User(lock) icon	Marks it for user (general user) lock status.
	Administrator lock icon	Administrator lock icon	Marks it for administrator and general user lock status.
7	Memory capacity icon	Inner and external (USB) memory capacity icon	Displays data capacity of internal memory as bar graph.
8	2011/02/07 MON 15:17:34	Date/Time display	Displays current date and time. In summer time season, (S) mark is also displayed at front of year.

## QUICK MENU

QUICK MENU consists of usually used parameters for quickly parameter setting.

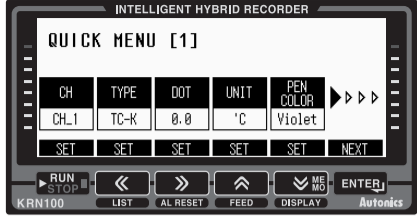

### 1) Parameters of QUICK MENU

Page	Parameter	Description	Linked parameters
QUICK MENU [1]	CH	Select channel for the QUICK MENU[1] setting.	
	TYPE	Input type	[INPUT SETUP]-[Input Type]
	DOT	Decimal point	[INPUT SETUP]-[Range/Scale Point]
	UNIT	Display/Temperature unit	[INPUT SETUP]-[Display/Temp Unit]
QUICK MENU [2]	PEN COLOR	Pen color	[INPUT SETUP]-[Pen Color]
	CH	Select channel for the QUICK MENU[2] setting.	
	LOW RANGE	Low-limit input value or graph scale value	[INPUT SETUP]-[Low Range] or [INPUT SETUP]-[Low Graph Scale]
	HIGH RANGE	High-limit input value or graph scale value	[INPUT SETUP]-[High Range] or [INPUT SETUP]-[High Graph Scale]
QUICK MENU [3]	LOW SCALE	Low-limit scale value	[INPUT SETUP]-[Low Scale]
	HIGH SCALE	High-limit scale value	[INPUT SETUP]-[High Scale]
	PRINT MODE	Record mode	[RECORD SETUP]-[Record Mode]
	PRINT SPEED	Standard record speed	[RECORD SETUP]-[Standard Speed]
QUICK MENU [4]	PRINT MEMO	Digital memo period	[RECORD SETUP]-[Memo Period]
	BACK LIGHT	LCD backlight	[SYSTEM SETUP]-[Backlight]
	LCD ON/OFF	LCD backlight On/Off	[SYSTEM SETUP]-[Backlight On/Off]
	USB REC	Memory save	[FILE/MEMORY SETUP]-[USB LogData Save]
QUICK MENU [4]	USB COPY	Call USB COPY window	[FILE/MEMORY SETUP]-[USB Memory Copy/Move]
	UPGRADE	Call upgrade window	[USER/INFORMATION SETUP]-[Firmware Upgrade]
	CANCEL	Cancel the settings	
	SAVE	Save the setting of QUICK MENU[1] to [4].	

※Refer to "KRN100 user manual".

## 2) QUICK MENU Setting

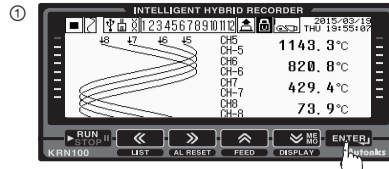

Press the **ENTER** key once in RUN mode and it enters to QUICK MENU.  
QUICK MENU consists of usually used parameters for quickly parameter setting.

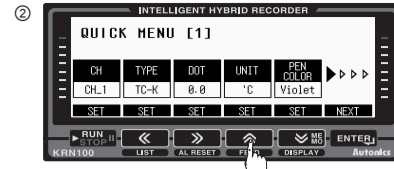

Set the keys following each parameter. Press the **NEXT** key and it moves to next page. E.g.) When changing the temperature unit (°C→°F) of CH1, press the **SET** key.

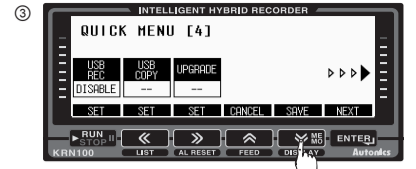

After completing the setting, press the **SAVE** key at QUICK MENU[4] and save the settings. It returns to RUN mode.

• E.g.) In case of CH1, recording as input type=TC-U, low-limit input value=300, standard record speed=240mm/h

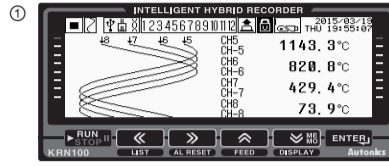

Press the **ENTER** key in RUN mode to enter QUICK MENU.

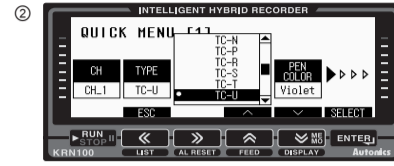

Press the **SET** key at QUICK MENU [1] and below screen is displayed. Set input type [TYPE] as TC-U by pressing **SET** key and press the **ENTER** key.

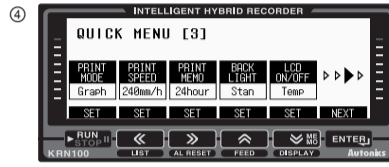

Press the **NEXT** key once and it moves to QUICK MENU [3]. Press the **SET** key and set standard record speed [PRINT SPEED] as 240mm/h.

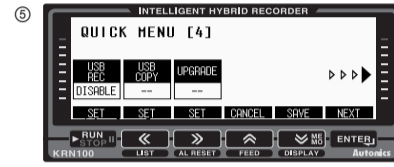

Press the **NEXT** key once and it moves to QUICK MENU [4]. Press the **SAVE** key to save the settings of QUICK MENU [1] to [4] and it returns to RUN mode.

## Parameters

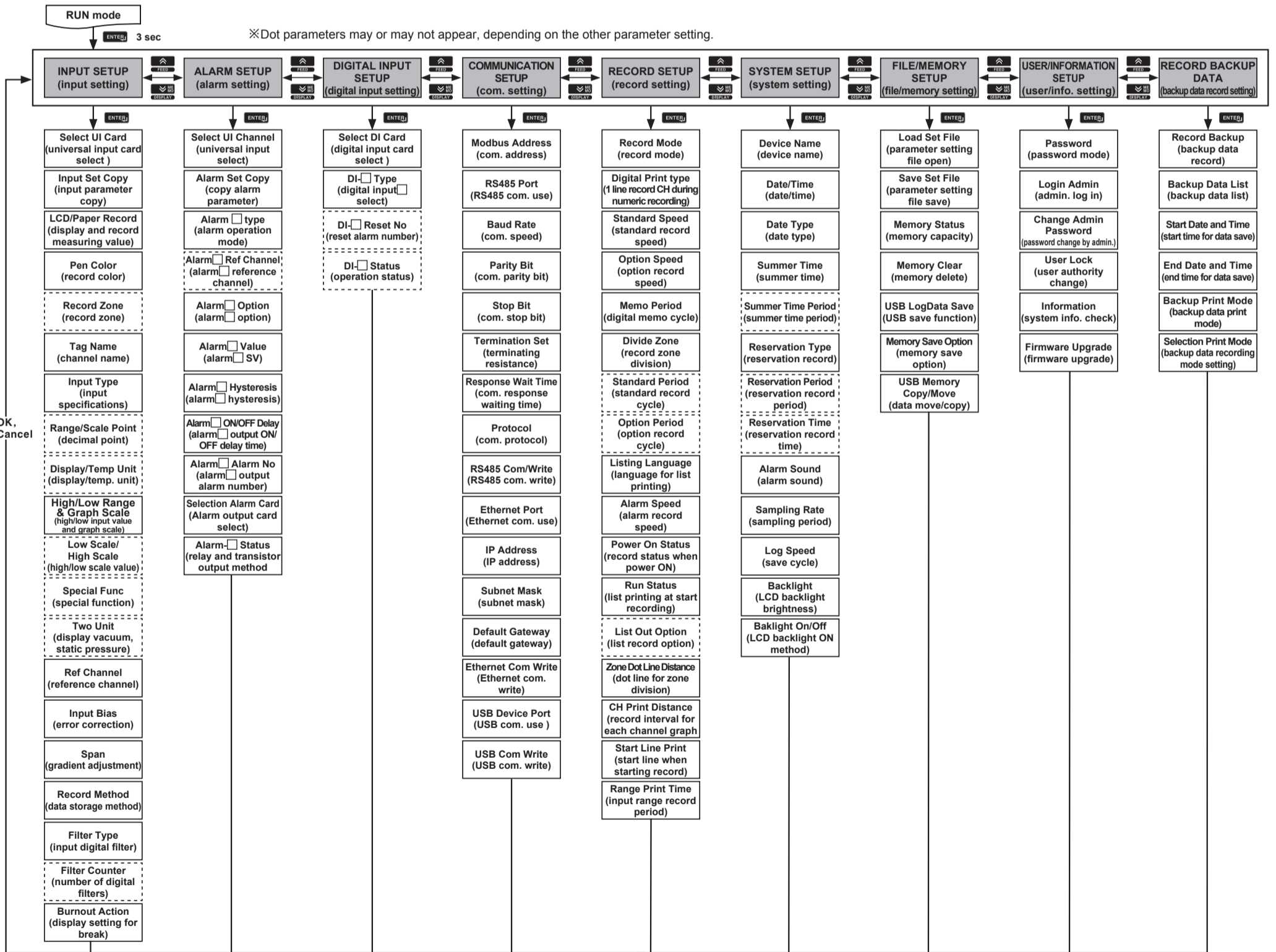

## Operation

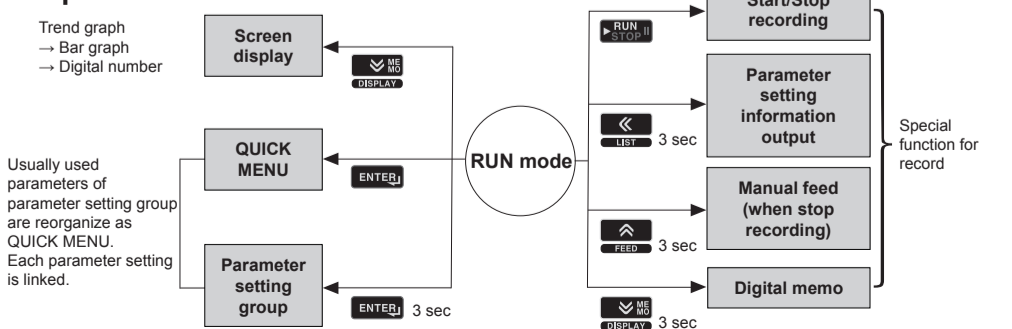

## Major Products

- Photoelectric Sensors
- Fiber Optic Sensors
- Door Sensors
- Door Side Sensors
- Area Sensors
- Proximity Sensors
- Pressure Sensors
- Rotary Encoders
- Connectors/Sockets
- Switching Mode Power Supplies
- Control Switches/Lamps/Buzzers
- I/O Terminal Blocks & Cables
- Stepper Motors/Drivers/Motion Controllers
- Graphic/Logic Panels
- Field Network Devices
- Laser Marking System(Fiber, CO<sub>2</sub>, Nd:YAG)
- Laser Welding/Cutting System
- Temperature Controllers
- Temperature/Humidity Transducers
- SSRs/Power Controllers
- Counters
- Timers
- Panel Meters
- Tachometer/Pulse(Rate) Meters
- Display Units
- Sensor Controllers
- Recorders
- Indicators
- Converters
- Controllers
- Thyristor Units
- Pressure Transmitters
- Temperature Transmitters

**Autonics Corporation**  
http://www.autonics.com

Trusted Partner In Industrial Automation

HEADQUARTERS: 18, Bansong-ro 513beon-gil, Haeundae-gu, Busan, South Korea, 48002  
OVERSEAS SALES: #402-303, Bucheon Techno Park, 655, Pyeongcheon-ro, Wonmi-gu, Bucheon, Gyeonggi-do, South Korea, 14502  
TEL: 82-32-610-2730 / FAX: 82-32-329-0728  
E-mail: sales@autonics.com