

# SRC1 Series Single-Phase, Slim Detachable Heatsink Type SSR

## Single-Phase, Slim Detachable Heatsink Type SSR

### ■ Features

- Slim, compact size (22.5 mm width)
- Dielectric strength: 4000 VAC
- High heat dissipation efficiency with ceramic PCB
- Zero cross turn-on, random turn-on models available
- Input Indicator (green LED)

**⚠ Please read "Safety considerations" in operation manual before using.**



### ■ Ordering Information

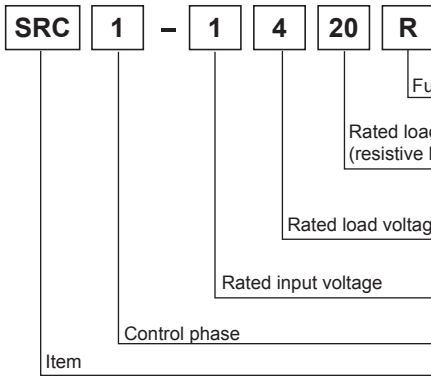

Function	No Mark	Zero cross turn-on
	R	Random turn-on
Rated load current (resistive load)	15	15A
	20	20A
	30	30A
Rated load voltage	2	24-240VAC
	4	48-480VAC
Rated input voltage	1	4-30VDC
	4	90-240VAC
Control phase	1	Single-phase
Item	SRC	Solid State Relay (slim type)

Model	Rated input voltage	Rated load current	Rated load voltage	Function
SRC1-1215	4-30VDC	15A	24-240VAC	Zero cross turn-on
SRC1-4215	90-240VAC			
SRC1-1220	4-30VDC	20A		
SRC1-4220	90-240VAC			
SRC1-1230	4-30VDC	30A		
SRC1-4230	90-240VAC			
SRC1-1420	4-30VDC	20A	48-480VAC	Zero cross turn-on
SRC1-4420	90-240VAC			Random turn-on
SRC1-1420R	4-30VDC			

- (A) Photoelectric Sensors
- (B) Fiber Optic Sensors
- (C) Door/Area Sensors
- (D) Proximity Sensors
- (E) Pressure Sensors
- (F) Rotary Encoders
- (G) Connectors/ Connector Cables/ Sensor Distribution Boxes/Sockets
- (H) Temperature Controllers
- (I) SSRs / Power Controllers
- (J) Counters
- (K) Timers
- (L) Panel Meters
- (M) Tacho / Speed / Pulse Meters
- (N) Display Units
- (O) Sensor Controllers
- (P) Switching Mode Power Supplies
- (Q) Stepper Motors & Drivers & Controllers
- (R) Graphic/ Logic Panels
- (S) Field Network Devices
- (T) Software

# SRC1 Series

## ■ Specifications

### ◎ Input

Rated input voltage range	<b>4-30VDC</b> ≡		<b>90-240VACrms</b> ~ (50/60Hz)	
Allowable input voltage range	4-32VDC≡		85-264VACrms~ (50/60Hz)	
Max. input current	9mA (Zero cross turn-on), 13mA (Random turn-on)		7mA <sub>Arms</sub> (240VACrms~)	
Pick-up voltage	Min. 4VDC≡		Min. 85VACrms~	
Drop-out voltage	Max. 1VDC≡		Max. 10VACrms~	
Turn-on time	Zero cross turn-on	Max. 0.5 cycle of load source + 1ms		Max. 1.5 cycle of load source + 1ms
	Random turn-on	Max. 1ms		—
Turn-off time	Max. 0.5 cycle of load source + 1ms		Max. 1.5 cycle of load source + 1ms	

### ◎ Output

Rated load voltage range	<b>24-240VACrms</b> ~ (50/60Hz)			<b>48-480VACrms</b> ~ (50/60Hz)	
Allowable load voltage range	24-264VACrms~ (50/60Hz)			48-528VACrms~ (50/60Hz)	
Rated load current	Resistive load (AC-51) <sup>※1</sup>	15A <sub>Arms</sub>	20A <sub>Arms</sub>	30A <sub>Arms</sub>	20A <sub>Arms</sub>
Min. load current		0.15A <sub>Arms</sub>	0.2A <sub>Arms</sub>	0.2A <sub>Arms</sub>	0.5A <sub>Arms</sub>
Max. 1 cycle surge current (60Hz)		190A	270A	330A	300A
Max. non-repetitive surge current (I <sup>2</sup> t, t=8.3ms)		150A <sup>2</sup> s	300A <sup>2</sup> s	500A <sup>2</sup> s	350A <sup>2</sup> s
Peak voltage (non-repetitive)	600V			1200V (zero cross turn-on), 1000V (random turn-on)	
Leakage current (Ta=25°C)	Max. 10mA <sub>Arms</sub> (240VAC~/60Hz)			Max. 10mA <sub>Arms</sub> (480VAC~/60Hz)	
Output on voltage drop[V <sub>pk</sub> ] (Max. load current)	Max. 1.6V				
Static off-state dv/dt	500V/μs				

※1: AC-51 is utilization category at IEC60947-4-3.

### ◎ General Specifications

Dielectric strength (Vrms)	4000VAC~ 50/60Hz 1 min (Input-Output, Input/Output-Case)				
Insulation resistance	Over 100MΩ (at 500VDC≡ Megger) (Input-Output, Input/Output-Case)				
Indicator	Input indicator: Green LED				
Vibration	Mechanical	0.75mm amplitude at frequency of 10 to 55Hz (for 1 min) in each X, Y, Z direction for 1 hour			
	Malfunction	0.5mm amplitude at frequency of 10 to 55Hz (for 1 min) in each X, Y, Z direction for 10 min			
Shock	Mechanical	300m/s <sup>2</sup> (approx. 30G) in each X, Y, Z direction for 3 times			
	Malfunction	100m/s <sup>2</sup> (approx. 30G) in each X, Y, Z direction for 3 times			
Environment	Ambient temp.	-30 to 80°C (in case of the rated input voltage 90-240VAC~: -20 to 70°C), storage: -30 to 100°C (The rated load current capacity is different depending on ambient temperature. Refer to ■ SSR Derating Curve!.)			
	Ambient humi.	45 to 85%RH, storage: 45 to 85%RH			
Input terminal connection	Min. 1×0.5mm <sup>2</sup> (1×AWG20), Max. 1×1.5mm <sup>2</sup> (1×AWG16) or 2×1.5mm <sup>2</sup> (2×AWG16)				
Output terminal connection	Min. 1×0.75mm <sup>2</sup> (1×AWG18), Max. 1×4mm <sup>2</sup> (1×AWG12) or 2×2.5mm <sup>2</sup> (2×AWG14)				
Input terminal fixed torque	0.75 to 0.95N·m				
Output terminal fixed torque	1.0 to 1.35N·m				
Approval					
Weight <sup>※1</sup>	Approx. 119g (approx. 85g)				

※1: The weight includes packaging. The weight in parenthesis is for unit only.

※Environment resistance is rated at no freezing or condensation.

※For wiring the terminal, an O-ring terminal must be used.

# Single-Phase, Slim Detachable Heatsink Type SSR

## Dimensions & Mounting

### Dimensions

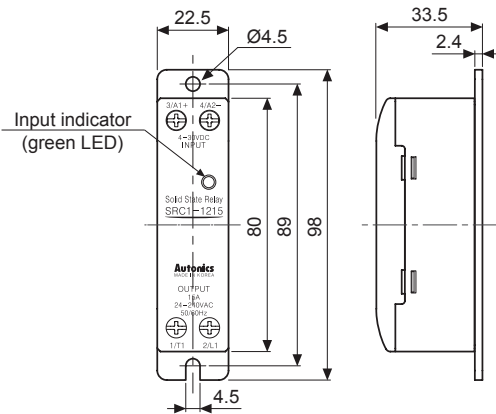

### Hole cut-out for panel front mounting

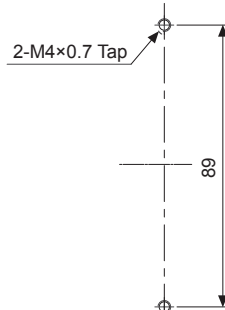

※Screw tightening torque for mounting: 1.8 to 2.5N·m

### Installation interval

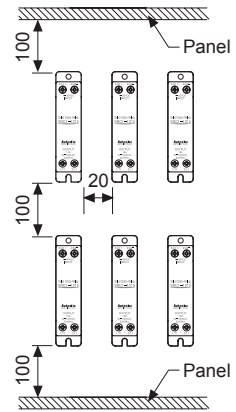

**High temperature caution**  
Make sure do not touch the heat sink or the unit body while power is supplied or right after load power is turned off. If not, it may cause a burn.

※For mounting multiple SSR, please keep certain installation intervals for heat prevention.  
For horizontal installation (when the heights of input part and output part are equal), it is recommended to apply 50% of rated load current.

## Connections

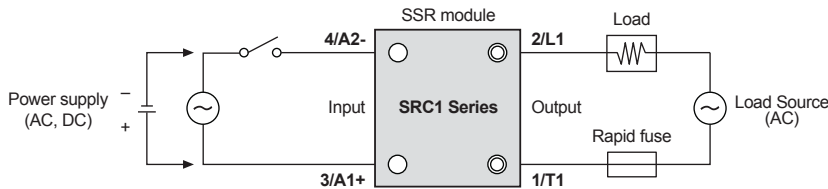

## SSR Derating Curve

### SR1-1215/4215

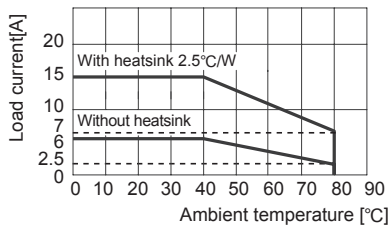

### SR1-1220/4220

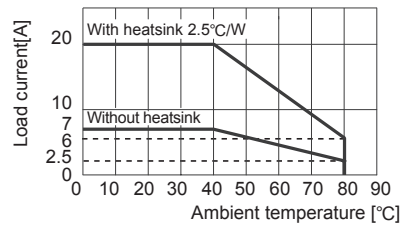

### SR1-1420/4420/1420R

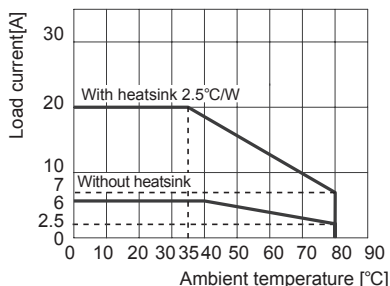

### SR1-1230/4230

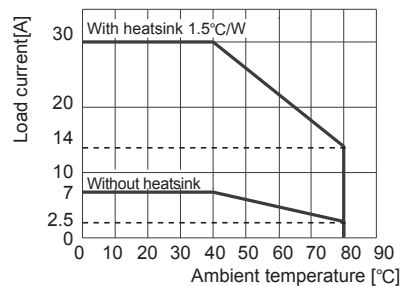

△Please supply less than 50% of the rated load current when installing several SSRs closely due to decreasing effectiveness of protection against heat.

- (A) Photoelectric Sensors
- (B) Fiber Optic Sensors
- (C) Door/Area Sensors
- (D) Proximity Sensors
- (E) Pressure Sensors
- (F) Rotary Encoders
- (G) Connectors/ Connector Cables/ Sensor Distribution Boxes/ Sockets
- (H) Temperature Controllers
- (I) SSRs / Power Controllers
- (J) Counters
- (K) Timers
- (L) Panel Meters
- (M) Tacho / Speed / Pulse Meters
- (N) Display Units
- (O) Sensor Controllers
- (P) Switching Mode Power Supplies
- (Q) Stepper Motors & Drivers & Controllers
- (R) Graphic/ Logic Panels
- (S) Field Network Devices
- (T) Software

## ■ Proper Usage



### High temperature caution

Make sure do not touch the heat sink or the unit body while power is supplied or right after load power is turned off. If not, it may cause a burn.



### Cautions during use

1. Attach a heatsink and ventilate for smooth convection current. If not, congested heat transfer may cause product failure or malfunction.
2. For mounting multiple SSR, please keep certain installation intervals for heat prevention. For horizontal installation (when the heights of input part and output part are equal), it is recommended to apply less than 50% of the rated load current.
3. Make sure do not touch the heatsink or the unit body while power is supplied or right after load power is turned OFF. If not, it may cause a burn.
4. Connect the proper cable for the rated load current with output terminal.
5. Use rapid fuse of which  $I^2t$  is under 1/2 of SSR  $I^2t$  in order to protect the unit from load's short-circuit current. In case of a short-circuit please replace the fuse which has same specification.
6. In case that load's current is lower than SSR min. load current, connect dummy resistance to the load in parallel so as to make load's current higher than SSR min. load current.
7. When selecting phase control with random turn-on model, install the noise filter between load and load's source
8. Make sure that the screw on output terminal is tightly fastened. Using the unit with loose bolt may cause product failure or malfunction.
9. Do not touch the load's terminal even if output is OFF. It may cause electric shock.
10. The signal input of the 4-30VDC model should be supplied by the insulated and limited voltage/current or by Class 2 power supply.
11. To attach the heatsink, use Thermal Grease as below or that of equal specification.  
※Thermal Grease: GE TOSHIBA (YG6111), KANTO-KASEI (FLOIL G-600), SHINETSU (G746)
12. Avoid following environments to install this unit.
  - ① Where temperature/humidity is beyond the specification
  - ② Where dew condensation occurs due to temperature change
  - ③ Where inflammable or corrosive gas exists
  - ④ Where direct rays of light exist
  - ⑤ Where severe shock, vibration or dust exists
  - ⑥ Where near facilities generating strong magnetic forces or electric noise
13. This product may be used in the following environments.
  - ① Indoors
  - ② Max. altitude: 2,000m
  - ③ Pollution degree 2
  - ④ Installation category III